Appendix K

Technical Memorandum I-5 JBLM Vicinity Transportation Operations and Safety Summary

This Page Intentionally Left Blank



I-5 JBLM Vicinity Congestion Relief Study

Technical Report

I-5 JBLM Vicinity Transportation Operations and Safety Summary

September 2016

Table of Contents

I-5 JBLM Vicinity Transportation Operations and Safety Summary	1
Table of Contents	i
List of Figures	iii
List of Tables	v
I-5 JBLM Vicinity Transportation Operations and Safety Summary	1
1.0 Background.....	1
2.0 Study Area for Traffic Analysis	1
3.0 Analysis of Existing Traffic Conditions.....	5
3.1 Existing I-5 Traffic Analysis	5
3.2 Travel Demand along I-5.....	6
3.3 Average I-5 Travel Speeds and Congestion	7
3.4 Hours of Congestion along I-5	10
3.6 Short-Trip Traffic on I-5	13
3.7 Factors affecting Existing Traffic Conditions along I-5	16
3.8 Intersection Analyses at the Reconfigured and Other Area Interchanges on I-5	17
3.9 Summary of Existing I-5 Traffic Conditions in the JBLM vicinity	19
4.0 Future Year Transportation System Assumptions	19
5.0 Traffic Forecasting Modeling Process and Assumptions	21
5.1 Macroscopic Model	21
5.2 Transit Sketch Planning Model	21
5.3 Mesoscopic Model.....	22
5.4 Modeling Procedure	22
6.0 2020 and 2040 I-5 No Build Alternative Traffic Analysis.....	23
6.1 Future No Build Alternative I-5 Traffic Volumes	23
6.2 Average Daily Traffic along the I-5 Mainline	26
6.3 2020 and 2040 No Build Alternative Travel Demand along I-5.....	26
6.4 Average 2020 and 2040 I-5 Travel Speeds	28
6.5 2020 and 2040 Hours of Congestion along I-5	32
6.6 2020 and 2040 On- and Off-Ramp No Build Alternative Volumes along I-5.....	32
6.7 Comparison of I-5 No Build Alternative Travel Times	37

6.8	Summary of Future Year Intersection Analysis with the No Build Alternative at the Reconfigured and Adjacent Interchanges along I-5.....	40
7.0	Description of the Build Alternative.....	43
8.0	2020 and 2040 I-5 Traffic Analysis for the Build Alternative	49
8.1	2020 and 2040 Build Alternative Average Peak Hour I-5 Traffic Volumes.....	49
8.2	Travel Demand along I-5 – Build Alternative.....	52
8.3	Future Build Alternative Average Peak Hour I-5 Travel Speeds.....	54
8.4	Peak Period I-5 Hours of Congestion – Build Alternative.....	57
8.5	Peak Hour I-5 On and Off-Ramp Volumes – Build Alternative	60
8.6	Comparison of I-5 Travel Times – No Build Alternative vs Build Alternative	62
8.7	Summary of Future Year Intersection Analysis at I-5 Reconfigured and Adjacent Interchanges for the Build Alternative	67
9.0	I-5 Collision Analysis	76
9.1	Collision Rates.....	76
9.2	I-5 Mainline Collision	77
9.3	Severity, Type and Contributing Circumstance for I-5 Collisions	80
9.4	Effect of Collision on the Traffic Flow and Speeds along I-5	81
9.5	Effect of Proposed Build Alternative on I-5 Collisions.....	82
10.0	Effects of the Build Alternative on Local Streets and Intersections.....	83
11.0	Transit Service and TDM Activities within the I-5 Study Area.....	86
11.1	Existing Transit Service along I-5.....	86
11.2	Park and Ride Lots.....	89
10.3	Commuter Trip Reduction.....	90
11.4	Transit Performance	91
11.5	Effect of the Build Alternative on Transit and Transportation Demand Management (TDM) Activities.....	94
12.0	Build Alternative Benefits to Bicycle and Pedestrian Travel in the Study Area	95
13.0	Construction Traffic Effects of the Build Alternative.....	95

List of Figures

Figure 1: Project Vicinity Map.....	2
Figure 2: Proposed Build Alternative	4
Figure 3: 2013 AM and PM Peak Hour Volumes on I-5 from Center Drive to Gravelly Lake Drive	6
Figure 4: Peak Hour Travel Demand Met on I-5 – Center Drive to Gravelly Lake Drive.....	7
Figure 5: 2013 AM and PM Peak Hour Average Travel Speed on I-5	8
Figure 6: Average Travel Speeds on I-5 during the 2013 PM Peak Period	9
Figure 7: Average Travel Speeds on I-5 during the 2013 PM Peak Period – Nisqually to SR 512	10
Figure 8: Hours of Congestion on I-5 during 2013 PM Peak Period – Center Drive to Gravelly Lake Drive	11
Figure 9: 2013 AM and PM Peak Hour On- and Off-Ramp Volume on I-5 - Center Drive to Gravelly Lake Drive	12
Figure 10: 2013 PM Northbound On- and Off-Ramp Volumes on I-5 – Berkeley Street to Gravelly Lake Drive	14
Figure 11: 2013 PM Peak Hour Southbound On- and Off-Ramp Volumes on I-5 – Steilacoom-DuPont Road to Mounts Road.....	15
Figure 12: Access Improvements to Madigan Gate.....	20
Figure 13: Interim Improvements Using Federal Grant Funding.....	20
Figure 14: Model Process Flowchart.....	23
Figure 15: 2020 and 2040 AM Peak Hour Volumes on I-5 – No Build Alternative	24
Figure 16: 2020 and 2040 PM Peak Hour Volumes on I-5 – No Build Alternative	25
Figure 17: 2020 and 2040 Met and Unmet Travel Demand on I-5 during PM Peak Hour	27
Figure 18: 2020 and 2040 Met and Unmet Demand on I-5 during PM Peak 3-hours.....	28
Figure 19: 2020 and 2040 AM Peak Hour Average Travel Speeds on I-5 – No Build Alternative.....	29
Figure 20: 2020 and 2040 PM Peak Hour Average Travel Speeds on I-5 – No Build Alternative.....	29
Figure 21: 2020 and 2040 PM Peak Hour Travel Speeds on I-5 between Center Drive and Gravelly Lake Drive – No Build Alternative.....	31
Figure 22: Hours of Congestion on I-5 during 2020 and 2040 PM Peak Periods from Center Drive to Gravelly Lake Drive – No Build Alternative	33
Figure 23: Travel Speeds on I-5 during the 2020 and 2040 PM Peak Period – No Build Alternative	34

Figure 24: 2020 and 2040 AM On- and Off-Ramp Volumes on I-5 from Center Drive to Gravelly Lake Drive – No Build Alternative	35
Figure 25: 2020 and 2040 PM On- and Off-Ramp Volumes on I-5 from Center Drive to Gravelly Lake Drive – No Build Alternative	36
Figure 26: Comparison of Southbound Cumulative Travel Times during AM and PM Peak Hours – No Build Alternative.....	38
Figure 27: Comparison of Northbound Cumulative Travel Times during AM and PM Peak Hours – No Build Alternative.....	39
Figure 28: Proposed Build Alternative	44
Figure 29: Existing and Proposed I-5 Build Alternative with Average Daily Traffic	45
Figure 30: Proposed Thorne Lane and Berkeley Street Interchange Concepts.....	46
Figure 31: Proposed Gravelly-Thorne Connector	47
Figure 32: Recommended Bicycle/Pedestrian Pathway Concept	48
Figure 33: Average 2020 and 2040 AM Peak Hour Volumes on I-5 from Center Drive to Gravelly Lake Drive – Build Alternative	50
Figure 34: Average 2020 & 2040 PM Peak Hour Vehicles along I-5 from Center Drive Road to Gravelly Lake Drive – Build Alternative	51
Figure 35: 2020 & 2040 Travel Demand along I-5 during AM and PM Peak Hours from Center Drive to Gravelly Lake Drive – Build Alternative.....	52
Figure 36: Comparison of 3-Hour PM Peak Period Demand Met on I-5 in the Vicinity of JBLM .	53
Figure 37: 2020 & 2040 AM Peak Hour Travel Speed along I-5 from Center Drive to Gravelly Lake Drive – Build Alternative	55
Figure 38: 2020 & 2040 PM Peak Hour Travel Speed along I-5 from Center Drive to Gravelly Lake Drive – Build Alternative.....	56
Figure 39: 2020 and 2040 PM Peak Hour Travel Speeds on I-5 between Center Drive and Gravelly Lake Drive – Build Alternative	58
Figure 40: Hours of Congestion along I-5 during 2020 & 2040 PM Peak Period from Center Drive to Gravelly Lake Drive – Build Alternative	59
Figure 41: Travel Speeds along I-5 during the 2020 & 2040 PM Peak Period – Build Alternative	60
Figure 42: 2020 & 2040 AM On- and Off-Ramp Volume along I-5 from Center Drive to Gravelly Lake Drive – Build Alternative.....	61
Figure 43: 2020 & 2040 PM On- and Off-Ramp Volume along I-5 from Center Drive to Gravelly Lake Drive – Build Alternative.....	62
Figure 44: 2020 Cumulative PM Peak Hour Travel Times along I-5 between Center Drive and Gravelly Lake Drive –2020 No Build Alternative and Build Alternative.....	63

Figure 45: Comparison of No Build vs Build Alternatives for 2020 AM & PM Peak Hour Cumulative Travel Times through the Study Area.....	65
Figure 46: Comparison of No Build vs Build Alternatives for 2040 AM & PM Peak Hour Cumulative Travel Times through the Study Area.....	66
Figure 47: 2020 AM and PM Peak Hour Levels of Service for the No Build and Build Alternatives	69
Figure 48: 2040 AM and PM Peak Hour Levels of Service for the No Build and Build Alternatives	70
Figure 49: Comparison of No Build vs. Build Alternatives 2020 PM Peak Hour of 95 % Traffic Queues along Center Drive and Wilmington Drive in DuPont	73
Figure 50: Number of I-5 Collisions - Number of I-5 Collisions Center Drive to Gravelly Lake Drive -- 2010 to 2014.....	76
Figure 51: I-5 Mainline Collisions by Milepost.....	78
Figure 52: Distribution of I-5 Collisions by Time of Day between Center Drive and Gravelly Lake Drive	79
Figure 53: Severity of I-5 Collisions – Center Drive to Gravelly Lake Drive – 2010 to 2014	80
Figure 54: I-5 Collisions by Type – Center Drive to Gravelly Lake Drive – 2010 to 2014.....	80
Figure 55: Contributing Circumstances for I-5 Collisions – Center Drive to Gravelly Lake Drive – 2010 to 2014	81
Figure 56: Speeds on I-5 between Exits 114 and 127 with a 2 PM Crash.....	81
Figure 57: Existing Transit Service and Park and Ride Lots.....	87

List of Tables

Table 1: Summary of Interchange Delay and Level of Service (LOS) at the Reconfigured Interchanges and Other Area Interchanges	18
Table 2: 2013 Delay Summary at Main Gate Interchange.....	18
Table 3: Daily Traffic Growth on I-5 in the JBLM Vicinity	26
Table 4: Summary of Interchange Delay and Level of Service (LOS) at the Reconfigured Interchanges – No Build Alternative.....	41
Table 5: Summary of Interchange Delay and Level of Service (LOS) at other Area Interchanges – No Build Alternative.....	42
Table 6: Summary of Interchange Delay and Level of Service (LOS) at the Reconfigured Interchanges—No Build vs. Build Alternative.....	68

Table 7: Summary of Interchange Delay and Level of Service (LOS) at Other Area Interchanges—No Build vs. Build Alternatives	71
Table 8: 2020 AM and PM Peak Hour Intersection Level of Service at Center Drive Interchange using Meso Model – No Build and Build Alternatives	73
Table 9: 2020 Delay Summary at Main Gate Interchange – No Build vs. Build Alternative	74
Table 10: Collision Summary on I-5 from Center Drive to Gravelly Lake Drive	76
Table 11: Location of IU-5 Mainline, Ramp and Cross Street Collision Summary	77
Table 12: Comparison of 2020 and 2040 Predicted Collisions on I-5 – Center Drive Interchange to Gravelly Lake Drive Interchange.....	82
Table 13: 2020 and 2040 AM and PM Peak Hour Two-way Volumes on Local Streets near the Thorne Lane Interchange – No Build Alternative vs. Build Alternative.....	84
Table 14: 2020 and 2040 PM Peak Hour Two-way Volumes on Local Streets near the Berkeley Street Interchange – No Build Alternative vs. Build Alternative	85
Table 15: Park and Ride Lot Inventory	89
Table 16: Weekday PM Peak Period (3-6 PM) Transit Ridership in the Study Area	92
Table 17: Weekday PM Peak Hour (4-5 PM) Vanpool Ridership in Study Area	93
Table 18: Benefits of Transit and Vanpooling – Weekdays during 4 to 5 PM Peak Hour	94

List of Appendices

- A Methods & Assumptions Document, *I-5 Joint Base Lewis-McChord Interchange Justification Report & Environmental Documentation*, prepared by H.W. Lochner, Inc, & Shea Carr Jewell, Inc. in association with The Transpo Group, Inc. and Shannon & Wilson, Inc., April 2013
- B Summary of Intersection Turning Movement Volumes
- C No Build Alternative Intersection Analysis Summary
- D Summary of I-5 Mainline and Ramp Volumes
- E Description of Alternative Packages
- F Build Alternative Intersection Analysis Summary
- G Collision Summary of ISATe Model Results

I-5 JBLM Vicinity Transportation Operations and Safety Summary

1.0 Background

Interstate 5 (I-5) is a national highway of strategic importance as it extends from the US/Mexican Border to the US/Canadian border. It is the primary highway for the movement of goods and people traveling north and south on the west coast of the United States. I-5 is one of the most significant freight corridors in Washington State and is essential to the economic vitality of the Puget Sound region. Within the study area, I-5 serves a function in national defense by providing access to Joint Base Lewis-McChord (JBLM) and the State's National Guard at Camp Murray.

Over the past several years, traffic has increased along the entire I-5 corridor. Within the study area in south Pierce County, traffic has also grown. Between 1986 and 2011 the average annual daily traffic (AADT) on I-5 at DuPont increased 72 percent (68,600 to over 118,000 vehicles per day.) During this time, JBLM has evolved into a strategic military base, Camp Murray has expanded, and the City of Lakewood was established, and the cities of Lakewood, DuPont and Steilacoom have all grown in both population and employment.

In 2012, the Washington State Legislature appropriated funding to prepare the studies and analyses necessary to identify the causes and potential solutions for chronic congestion on I-5 in the vicinity of JBLM. This work included the *I-5 Corridor Feasibility Study*, completed in January 2014 and the *Multimodal Alternatives Analysis Study*, completed in March 2015. These studies identified mainline and interchange capacity scenarios and examined local street and transit options to reduce congestion and improve mobility along I-5.

As part of the Connecting Washington Program, the Washington State Legislature in 2015 approved design, right of way and construction funds for the I-5 JBLM Corridor Improvements. Figure 1 indicates the vicinity map for the project.

2.0 Study Area for Traffic Analysis

The Project Corridor study area generally includes I-5 between Mounts Road (Exit 116) on the south and Gravelly Lake Drive (Exit 124) on the north and includes the roads that access, parallel or influence this facility. Within this study area, I-5 is a divided interstate highway with three through lanes in each direction south of Thorne Lane and four through lanes in each direction north of Thorne Lane. All lanes are unmanaged general purpose lanes. There are seven interchanges in this roughly eight-mile study area (Exits 124, 123, 122, 120, 119, 118 and 116).

Figure 1: Project Vicinity Map

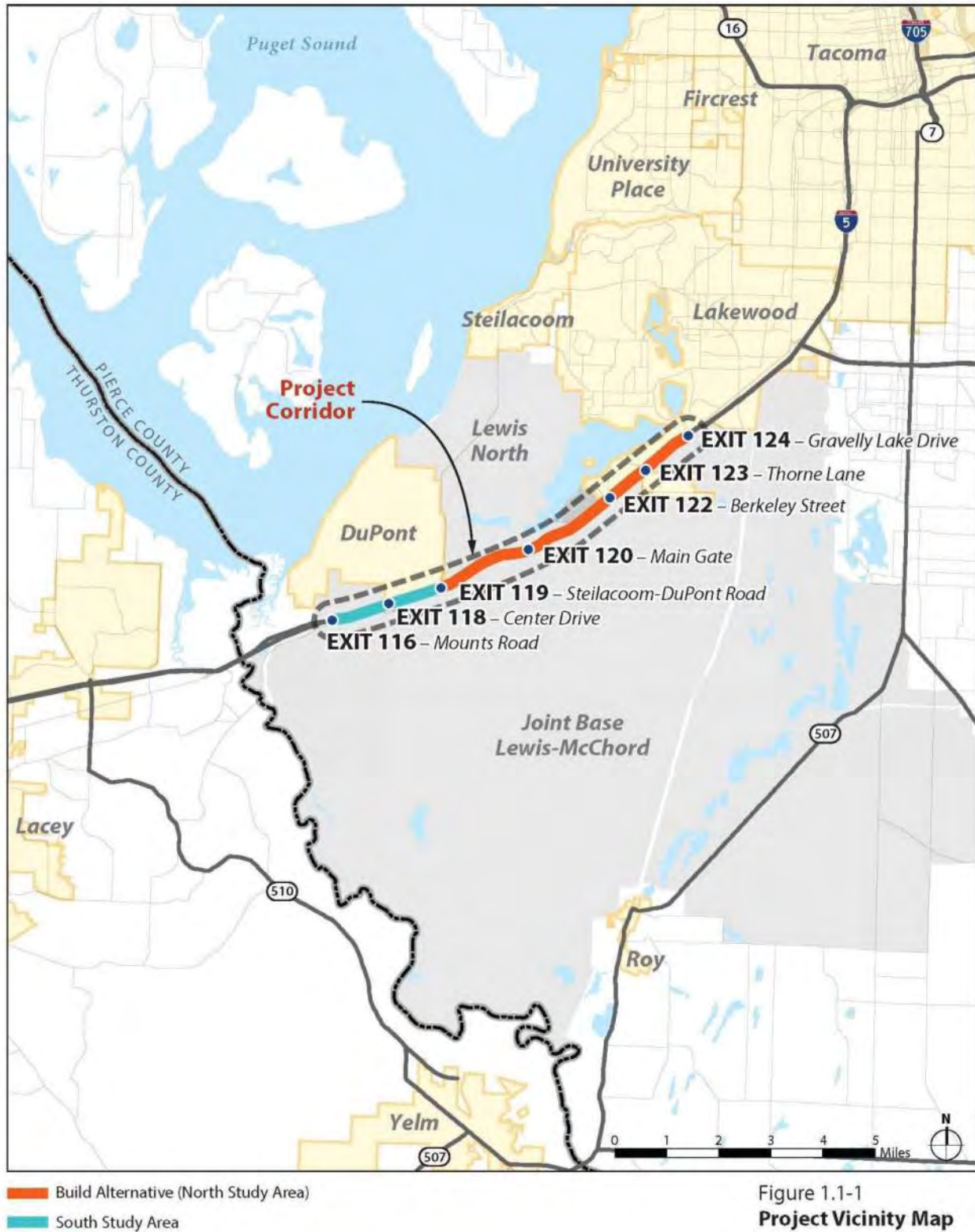

While the Project Corridor study area boundary includes the entire I-5 corridor through the JBLM vicinity, implementation of improvements would occur in phases. The northern portion of the corridor (referred to as the North Study Area), is generally situated between Steilacoom-DuPont Road (Exit 119) and Gravelly Lake Drive (Exit 124). A project-specific Build Alternative has been defined in this area. The Build Alternative includes modifications to the freeway mainline and interchanges between the vicinity of the Center Drive interchange (Exit 118) and the Gravelly Lake Drive interchange (Exit 124). They include two primary interchanges that would be reconstructed and four other study area interchanges that would be influenced by the I-5 mainline improvements.

Primary Interchanges Rebuilt with the Build Alternative

- I-5/Berkeley Street interchange (Exit 122)
- I-5/Thorne Lane interchange (Exit 123)

Interchanges Influenced by the Build Alternative

- Center Drive interchange (Exit 118)
- Steilacoom-DuPont Road interchange (Exit 119)
- Main Gate (41st Division Drive) interchange (Exit 120)
- I-5/Gravelly Lake Drive interchange (Exit 124)

The geographic coverage of the Build Alternative footprint is illustrated in Figure 2. NEPA environmental documentation and a corresponding Interchange Justification Report (IJR) for interstate access modifications have been prepared for this corridor segment. This report supports and provides added information for the Build Alternative analysis.

In the southern portion of the corridor, generally located between Mounts Road (Exit 116) and Steilacoom-DuPont Road (Exit 119), a specific build alternative has not been defined. This portion of the corridor is referred to as the South Study Area and has been evaluated at a corridor level. When a specific build alternative is defined more detailed analysis of traffic operations and safety will be conducted in the South Study Area.

Within the study area, I-5 is a divided interstate highway with three through lanes in each direction south of Thorne Lane and four through lanes in each direction north of Thorne Lane. These lanes are open to all traffic. Northbound and southbound auxiliary lanes are located between the Center Drive and Steilacoom-DuPont Road interchanges. A southbound auxiliary lane is also located between Center Drive and Mounts Road. In 2014, WSDOT added a southbound auxiliary lane between Thorne Lane and Berkeley Street as part of the TIGER III improvement project.

Through the study area, I-5 is physically constrained with secure military installations (JBLM and Camp Murray) on both sides and an active rail line paralleling immediately to the northwest. Alternative routes to move regional traffic are severely limited by the size of JBLM, and further

Figure 2: Proposed Build Alternative



limited by bodies of water, sensitive environmental areas, and locations of sites of archaeology or cultural significance. Because of security restrictions, access through the military installations is limited and alternative travel routes would require long detours.

Between mileposts 117.5 and 125.6 (essentially Center Drive to Gravelly Lake Drive), I-5 is situated on an easement whose ownership is retained by the Department of Defense (DoD). Changes to the existing easement to accommodate freeway improvements will require approval from DoD which can be a lengthy and complicated process.

3.0 Analysis of Existing Traffic Conditions

A summary of the existing I-5 traffic operations, including travel demand, travel speeds, congestion and travel times, is presented below. The analyses and procedures that were followed to evaluate existing and future operations used Synchro and Sidra software in accordance with the Highway Capacity Manual (HCM). The traffic analysis assumptions for this project are summarized in the *Methods & Assumptions Document for the I-5 Joint Base Lewis-McChord Vicinity Interchange Justification Report & Environmental Documentation*, contained in Appendix A.

3.1 Existing I-5 Traffic Analysis

Based on existing traffic counts collected in 2013, AM and PM peak hour two-way traffic volumes along the I-5 corridor ranged from approximately 7,500 vehicles to 10,900 vehicles. Figure 3 shows the AM and PM peak hour vehicles along I-5 by direction. Using 1,800 vehicles per hour as a maximum practical capacity per lane, the three-lane section has a maximum capacity of 5,400 vehicles and the four-lane section has a capacity of 7,200 vehicles (as indicated by the shaded areas on the charts). It is important to note that because of the slow speeds, stop-and-go traffic, and frequent lane changes, the actual volume that can be accommodated is below the practical capacity of I-5.

During the AM peak hour, the northbound lanes are at or near capacity from Center Drive to Thorne Lane. During the PM peak hour, the southbound lanes are at or near capacity south of the Main Gate Interchange and the northbound lanes are at or near capacity between Berkeley Street and Thorne Lane.

This level of traffic volume along the I-5 corridor together with the reduction in travel lanes at Thorne Lane creates lane turbulence and congestion that:

- Reduces the gap distance between vehicles
- Makes it more difficult for drivers to change lanes safely
- Causes drivers to slow down or even stop as other drivers try to change lanes with smaller gaps
- Results in higher number of rear-end and sideswipe collisions through this area of I-5

Figure 3: 2013 AM and PM Peak Hour Volumes on I-5 from Center Drive to Gravelly Lake Drive

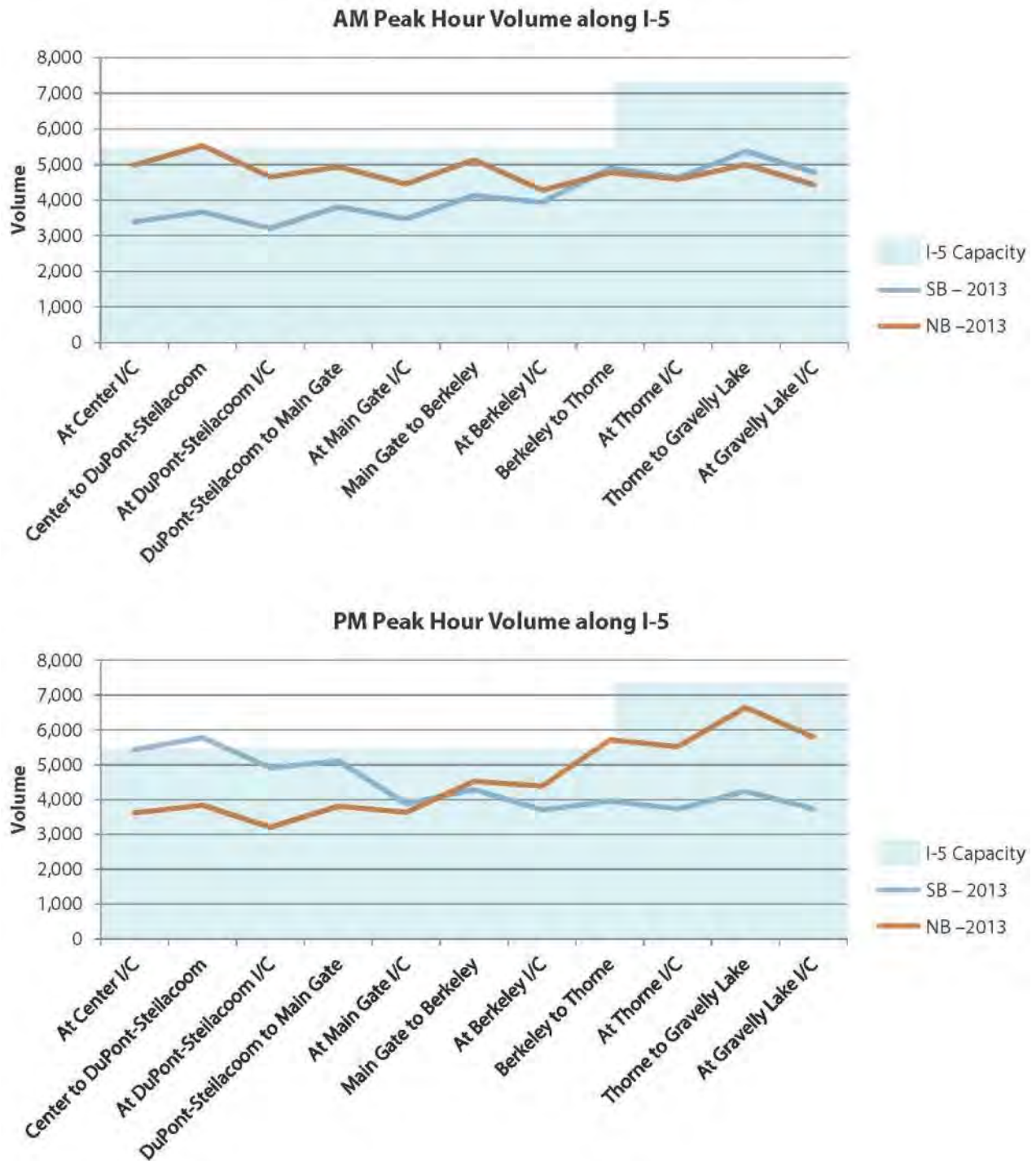

3.2 Travel Demand along I-5

Since the last widening of I-5 through the project area in 1975, there have been significant increases in traffic volumes and accompanying congestion along I-5 in the JBLM vicinity. This growth is associated with increased through traffic, local community development and JBLM

commute patterns. As shown in Figure 4 and based on output from the study area Mesoscopic model, over 88 percent of PM peak hour demand could use I-5 in the 2013 analysis base year. This means that approximately 12 percent of the persons who wanted to travel on I-5 during the PM peak hour could not do so because there was insufficient physical space for them to get on the highway. These trips likely spread into the hours adjacent to the PM peak, lengthening the overall multi-hour peak period.

Figure 4: Peak Hour Travel Demand Met on I-5 – Center Drive to Gravelly Lake Drive

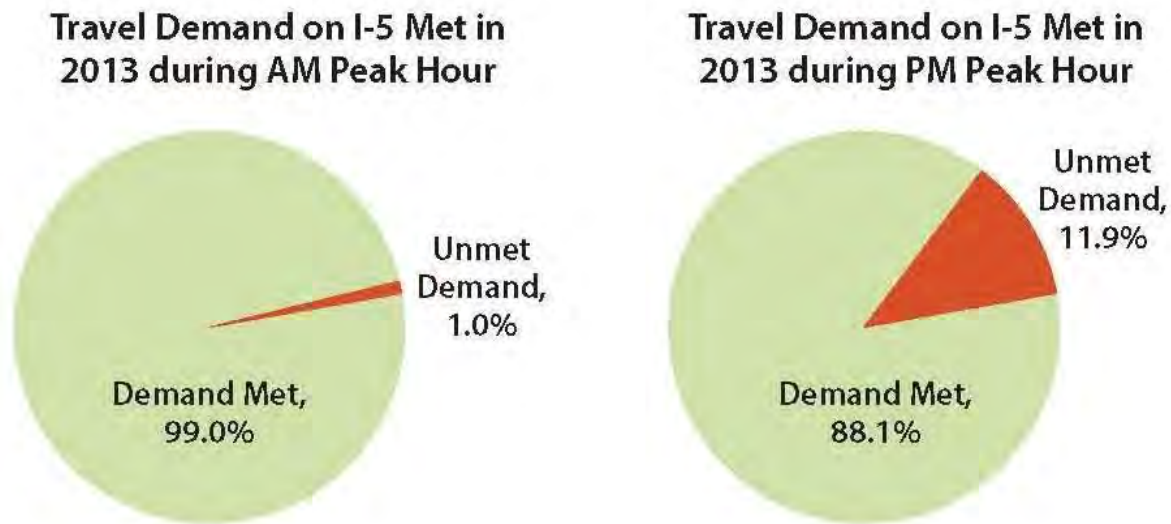

- Demand based on person miles of travel estimate from Mesoscopic travel model.

3.3 Average I-5 Travel Speeds and Congestion

Average travel speed along the I-5 corridor is a factor that WSDOT uses to illustrate congestion. In WSDOT's Highway System Plan 2007 - 2026, WSDOT uses 70 percent of posted speed (42 mph) to signify when congestion occurs at level of service (LOS) F (the shaded areas on Figure 5 are speeds below 70 percent of posted speeds). As can be observed from Figure 6, travel speeds in 2013 along I-5 in the AM peak hour are above 42 mph. However, during the PM peak hour in 2013, there are several segments of I-5 that fall below 42 mph.

Figure 5: 2013 AM and PM Peak Hour Average Travel Speed on I-5

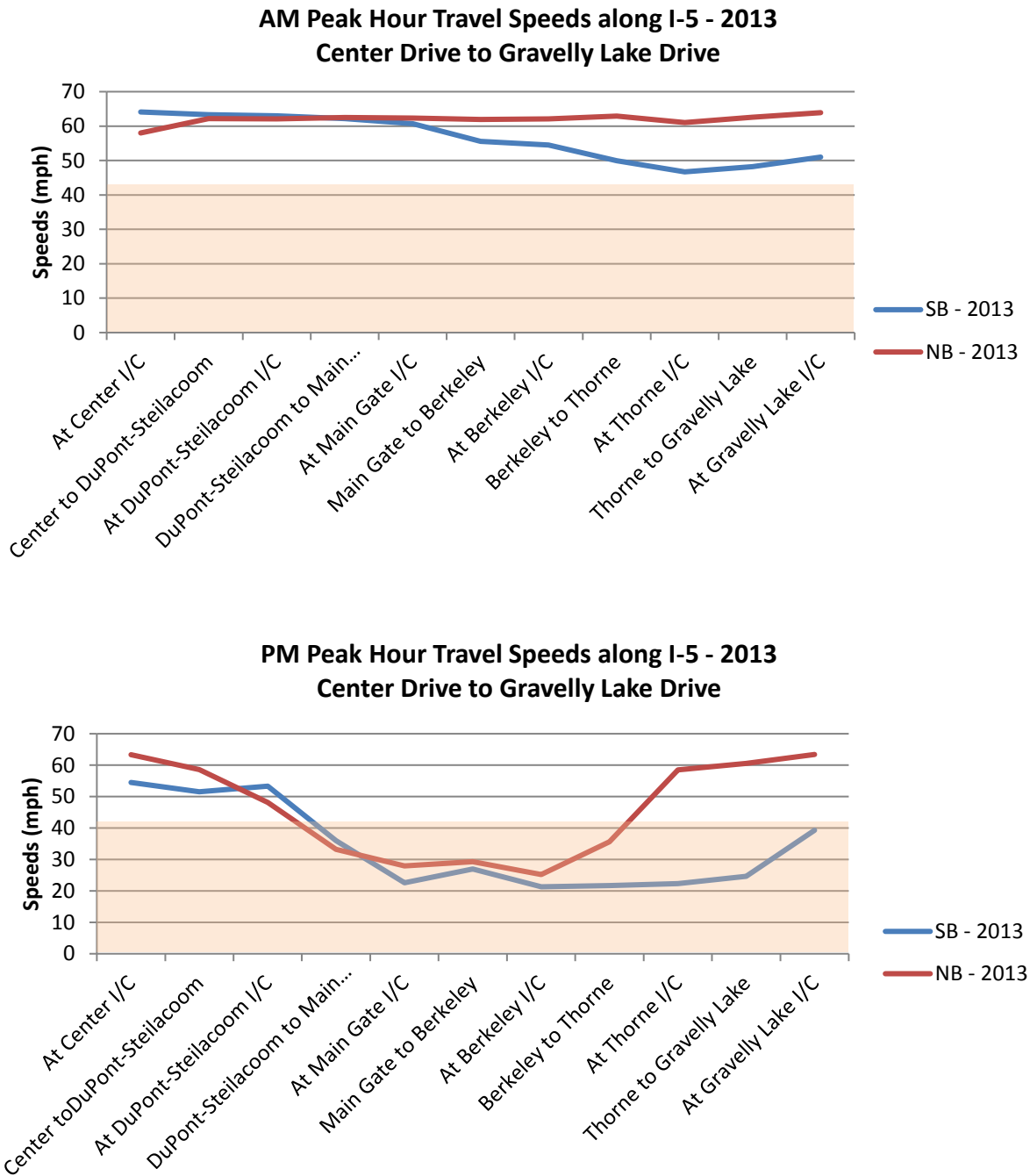

In the southbound direction average PM speeds are below 42 mph from Gravelly Lake Drive to Steilacoom-DuPont Road with the segment from Thorne Lane to Main Gate being near 20 mph. In the northbound direction, average PM speeds are below 42 mph between Steilacoom-DuPont Road and Thorne Lane. These low average speeds signify that several areas along I-5 in the JBLM vicinity have slow moving vehicles with periods of stop-and-go traffic.

Figure 6: Average Travel Speeds on I-5 during the 2013 PM Peak Period



3.4 Hours of Congestion along I-5

To estimate how many hours of congestion might occur along I-5, an operational analysis was conducted using INRIX travel data and this project’s Mesoscopic Model to estimate travel speeds along I-5 for a six-hour AM peak period and a six-hour PM peak period. Figure 7 illustrates the duration of slow speeds along I-5 at differing locations during the 2013 PM peak period on a typical weekday. The PM peak period that was evaluated ran from 2:00 PM to 8:00 PM. Congestion in both the northbound and southbound directions is shown. As indicated in the figure there are several areas where speeds fell below 42 mph, and for extended periods even below 20 mph. It also shows that these slow speeds extend well past the PM peak hour. In 2013, congestion during the PM peak period lasted for about three hours.

Figure 7: Average Travel Speeds on I-5 during the 2013 PM Peak Period – Nisqually to SR 512

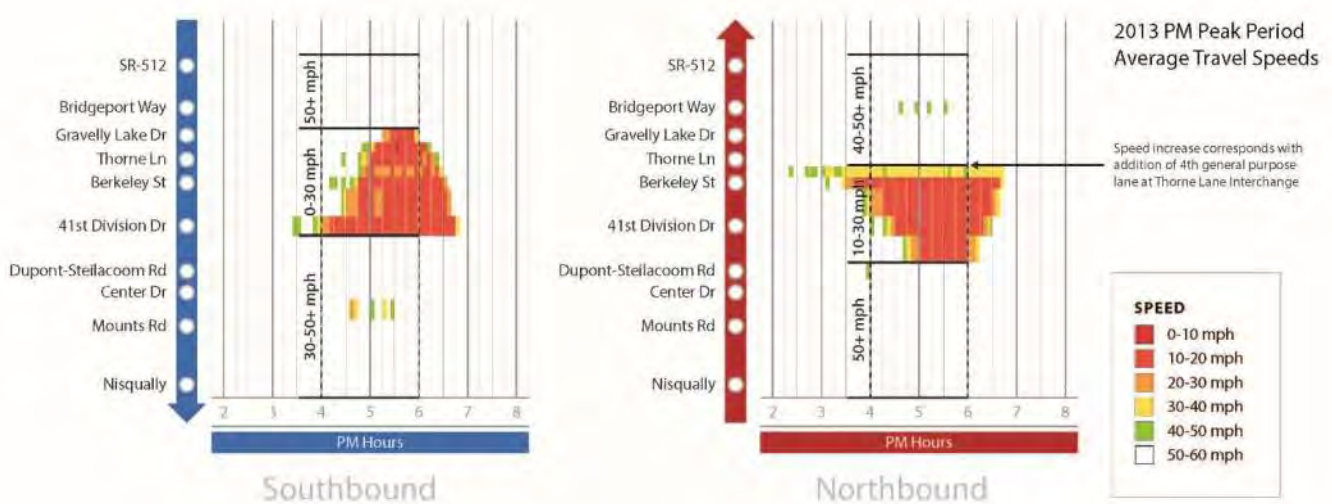

Based on the INRIX and model data, estimates were made of the number of hours the travel speed operated below 70 percent of posted speed or 42 mph. Based on the analysis, less than one hour of congestion occurred during the AM peak period in 2013 (not illustrated). During the PM peak period, several hours of congestion occur along I-5. As experienced by drivers today, this congestion can last from two to 3.5 hours. The hours of congestion during the PM peak period are illustrated in Figure 8.

Figure 8: Hours of Congestion on I-5 during 2013 PM Peak Period – Center Drive to Gravelly Lake Drive

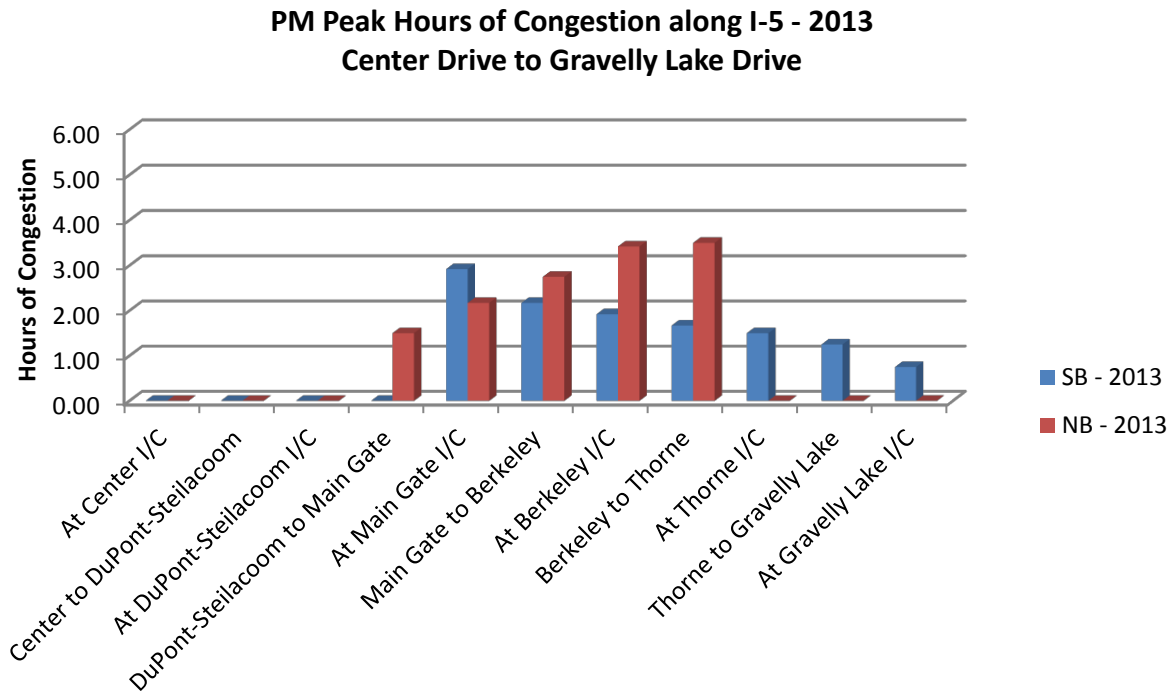

3.5 On- and Off-Ramp Volumes along I-5

One of the causes for congestion along I-5 through the JBLM area is the high volume of traffic switching lanes to enter and exit I-5. As shown in Figure 9, it can be observed that for the southbound direction during the AM peak hour, there are over 500 vehicles exiting at Thorne Lane, Berkeley Street, Main Gate and Steilacoom-DuPont Road interchanges. At the same time, there are over 500 drivers entering I-5 from Gravelly Lake Drive, over 300 from Main Gate and over 400 from Steilacoom-DuPont Road. All this traffic cannot be accommodated in the outside lane at the same time, so the exiting drivers must merge right from other lanes before their exit and entering drivers must merge left to clear the outside lane. These heavy merging movements are further complicated for southbound traffic entering north of Thorne Lane, as it must not only merge with the exiting traffic but also must then shift lanes to get past the Thorne Lane Interchange where the outside lane ends, reducing I-5 from four lanes to three lanes.

Figure 9: 2013 AM and PM Peak Hour On- and Off-Ramp Volume on I-5 - Center Drive to Gravelly Lake Drive

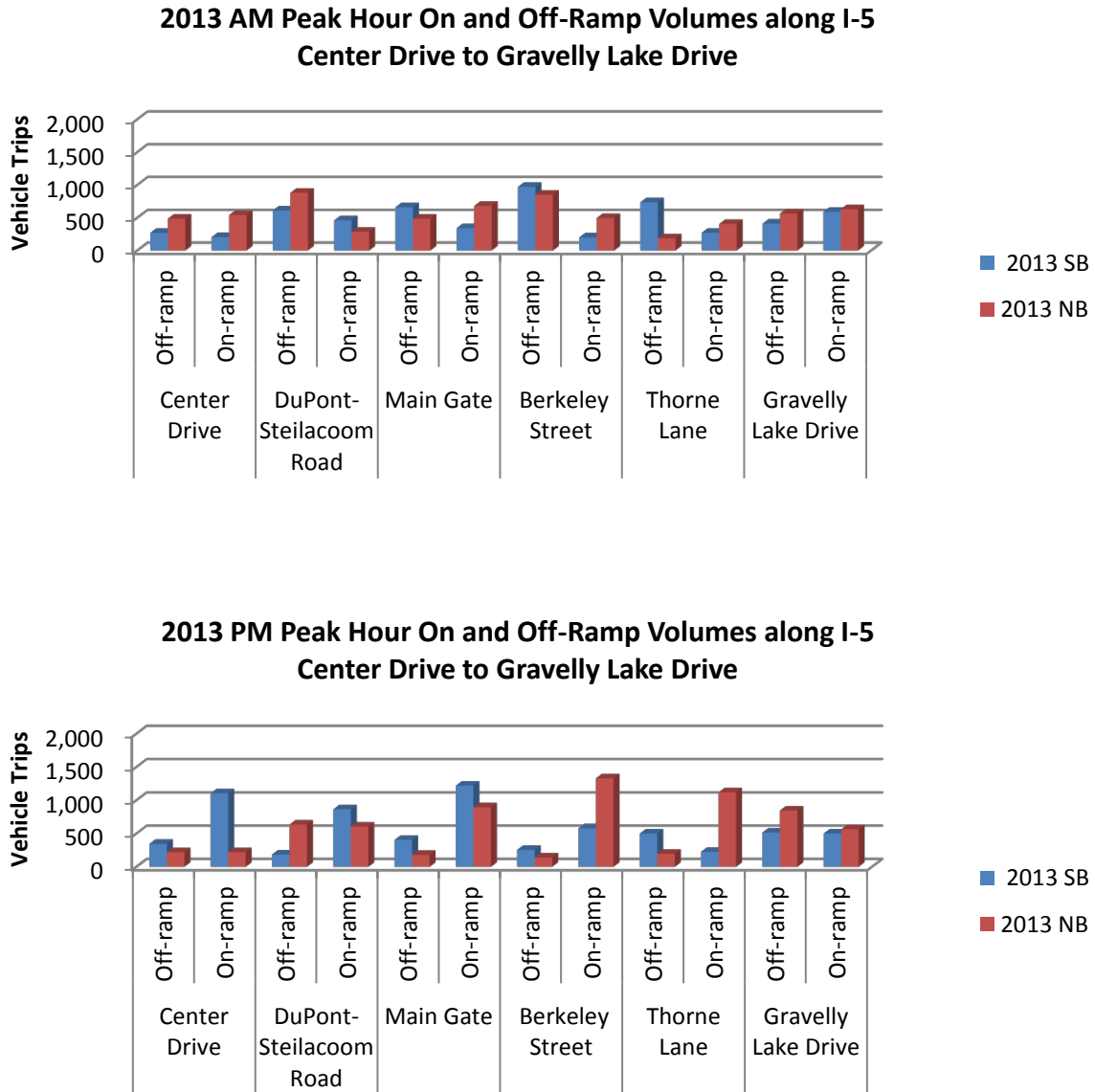

Similarly, during the PM peak hour in the northbound direction, there are over 500 vehicles merging onto I-5 at Steilacoom-DuPont Road, Main Gate, and Gravelly Lake Drive and over 1,000 vehicles merging onto I-5 at Berkeley Street and Thorne Lane. At the same time, there are over 500 vehicles exiting I-5 at Steilacoom-DuPont Road and Gravelly Lake Drive. All of this traffic cannot be in the outside lane at the same time, so drivers frequently change lanes as part of entering and exiting I-5.

These heavy lane change movements cause traffic to slow, increase congestion, result in an average of more than one traffic collision per day, and reduce the overall traffic throughput in the JBLM area.

To illustrate the impact of the on and off traffic merging and weaving, two locations are illustrated below. Figure 10 shows northbound weaving between Berkeley Street and Gravelly Lake Drive during a typical 2013 PM peak hour. Within this 1.5-mile distance, nearly 3,500 drivers are engaged in merging on or off the highway and weaving with existing through traffic which almost doubles the 1,800-vehicle capacity of the outside lane.

Figure 11 shows the high levels of weaving and merging that occur during the PM peak hour in the southbound direction between Steilacoom-DuPont Road and Mounts Road. Within this 1.5-mile segment of the freeway there are nearly 3,100 drivers, merging and weaving across travel lanes to enter or exit the freeway, well over the 1,800-vehicle capacity of the outside lane.

3.6 Short-Trip Traffic on I-5

Because of the high security military installations, I-5 is the main and essentially only traffic artery through the area for through trips, regional trips and short trips. As a result, there are several locations that have a significant volume of trips that begin and end within the project limits. Many of these short trips are military personnel living off-Base with their families in Lacey, DuPont, Steilacoom, Lakewood or other nearby communities, who generally use the gates closest to where they are stationed on the military base. Many of these short trips use I-5 as there are few to no alternatives for traveling between destinations within the study area.

Other short trips are to and from the Tillicum and Woodbrook neighborhoods. Because of the secure military base around these neighborhoods, these residents use I-5 to reach their destinations in Lakewood and other areas. Overall, these short trips contribute to the congestion and safety problems experienced in the corridor by increasing I-5 traffic volumes and contributing to the high level of weaving and merging activity.

Figure 10: 2013 PM Northbound On- and Off-Ramp Volumes on I-5 – Berkeley Street to Gravelly Lake Drive

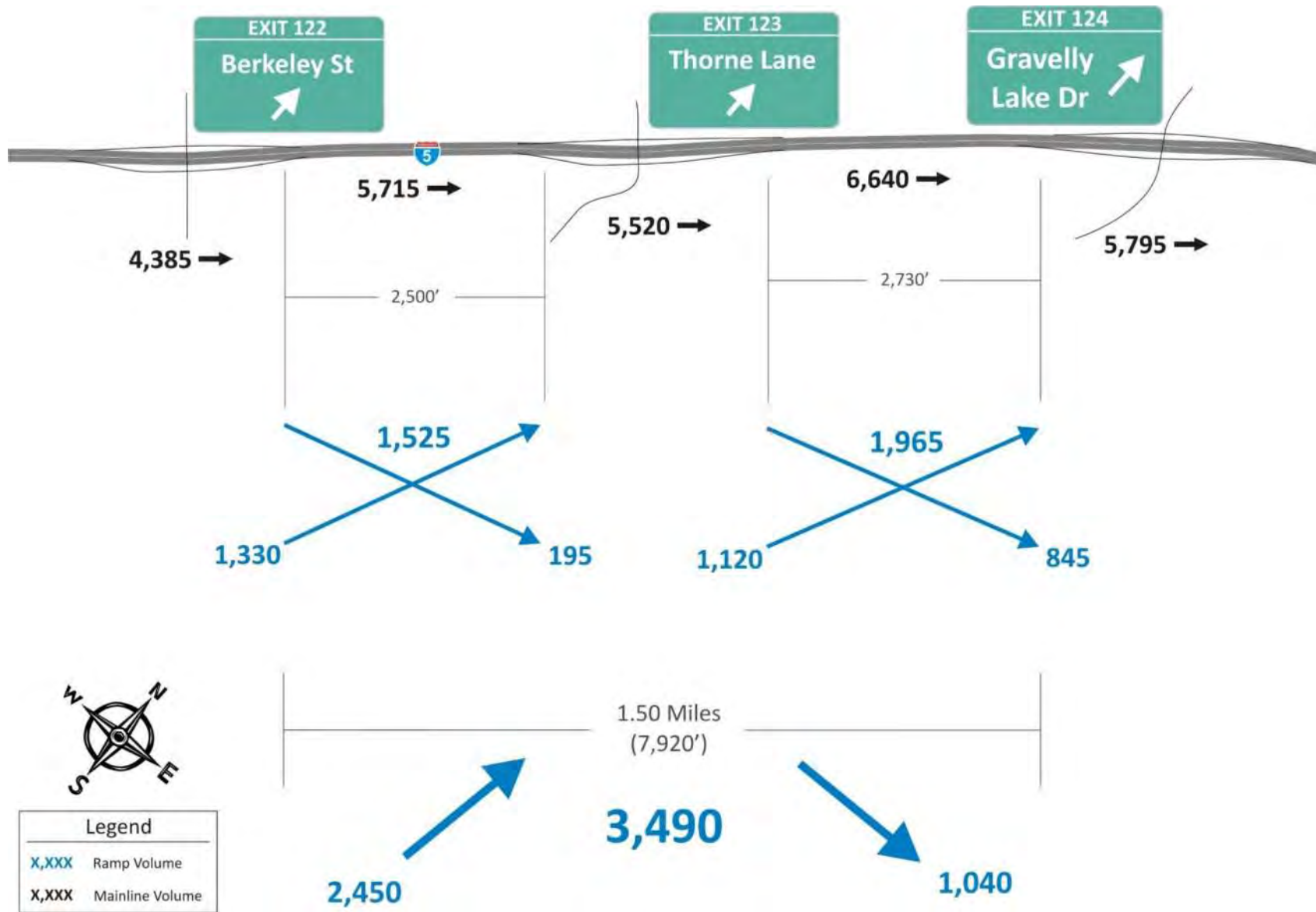
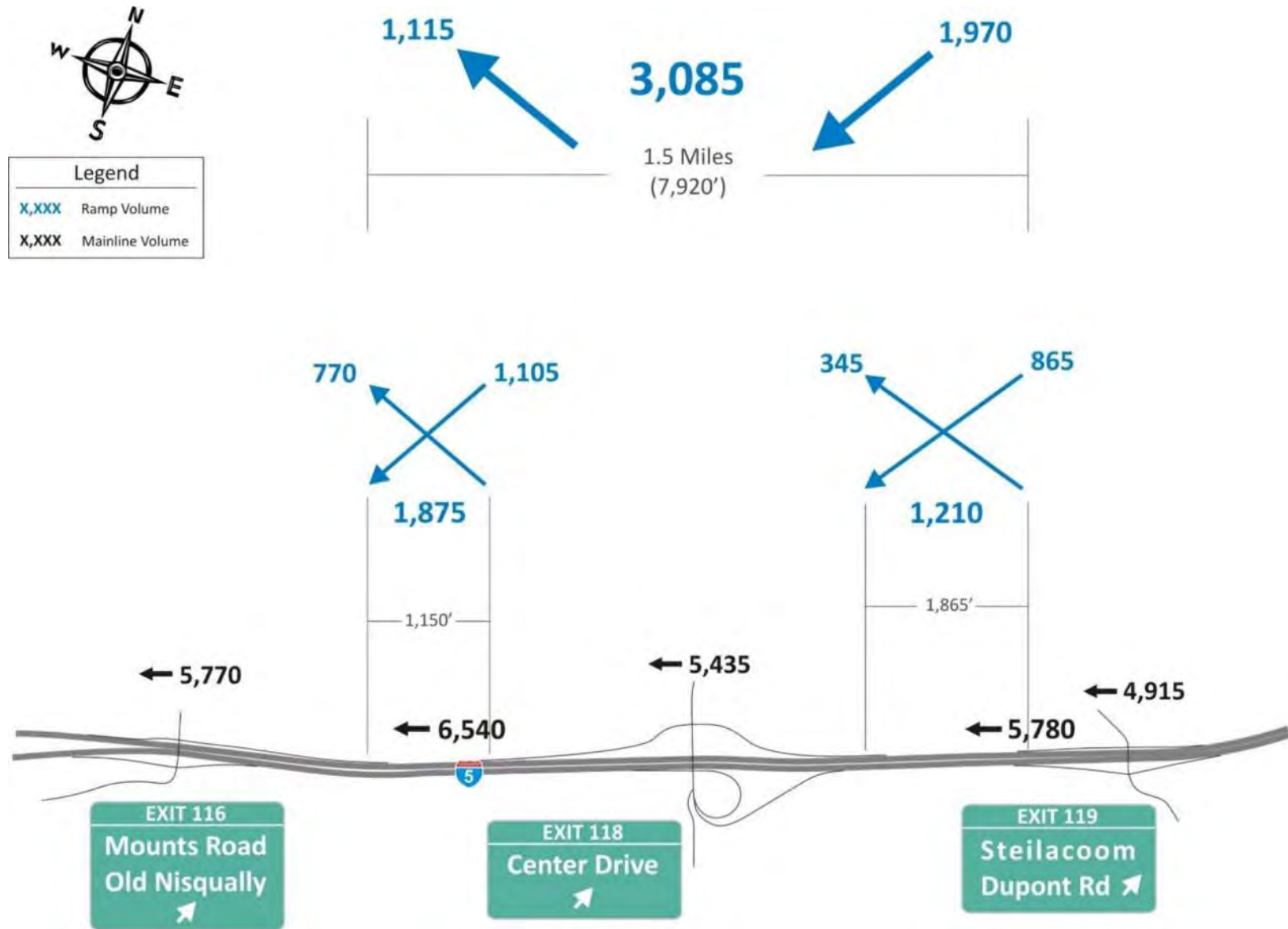

Figure 11: 2013 PM Peak Hour Southbound On- and Off-Ramp Volumes on I-5 – Steilacoom-DuPont Road to Mounts Road



3.7 Factors affecting Existing Traffic Conditions along I-5

Several factors affect traffic operations along I-5 and contribute to the chronic traffic congestion in the JBLM vicinity. These factors include:

- **Existing and growing traffic demand** and associated congestion during peak periods of the day along I-5 and at study area interchanges. Between 1986 and 2011, daily traffic volumes on I-5 in the study area increased by 73 percent, from just under 68,000 vehicles to over 118,000 vehicles. This growth is associated with increased through traffic, local community development, and JBLM commute patterns. These higher traffic volumes reduce the gap distances between vehicles, make it more difficult for drivers to change lanes safely and to recover from traffic crashes, and cause drivers to slow down or stop as other drivers try to change lanes with smaller gaps.
- **Few alternate routes** through the secure military installations, along with environmental and right-of-way constraints, limit opportunities to travel between Thurston County and Tacoma/Seattle.
- **Physical limitations** and constraints of I-5 through the study area including:
 - Change in the number of traffic lanes on I-5 at the Thorne Lane interchange (eight lanes north of Thorne Lane, six lanes south of Thorne Lane).
 - Several closely spaced I-5 interchanges (six) over a short distance (6.7 miles) between the Center Drive interchange and the Gravelly Lake Drive interchange.
 - Physical limitations of the interchanges with narrow bridges that constrain opportunities to increase highway capacity.
 - Adjacent rail line that limits highway improvement options.
- **Heavy on- and off-ramp volumes** at the interchanges between Center Drive and Gravelly Lake Drive. Entering and exiting traffic represents about half of the total traffic along I-5 in the study area. This traffic competes with high through traffic volumes, resulting in substantial weaving and merging activity.
- **Vehicle trips using I-5 for local and short distance** travel in the project area. Because of the secure military installations, I-5 is the main and essentially only traffic artery through the area for through trips, regional trips and short trips. As a result, several locations have a heavy volume of trips that begin and end within the project limits, competing for freeway space with regional and through traffic. Further information about these trip patterns can be found in the I-5 JBLM Congestion Relief Study, Travel Patterns and Characteristics report dated August, 2014.

3.8 Intersection Analyses at the Reconfigured and Other Area Interchanges on I-5

The 2013 intersection analyses at the I-5 interchanges were conducted using Synchro software following the Highway Capacity Manual (HCM) procedures. A summary of the intersection turning movement volumes used for the analysis is contained in Appendix B. The results of these analyses are summarized Table 1. A detailed listing of the No Build Alternative analysis results is located in Appendix C.

The analyses show that during the AM peak hour the following intersections are operating below LOS D:

- I-5 SB Ramps / Berkeley Street
- I-5 SB Ramps / Thorne Lane
- I-5 NB Ramps/ Thorne Lane

During the PM peak hour, the following intersections operate below LOS D:

- I-5 NB Ramps / Thorne Lane
- I-5 NB Ramps / Center Drive
- I-5 NB Ramps / Gravelly Lake Drive

As interim measures to address these deficiencies, WSDOT and the City of Lakewood have implemented several improvements. In 2014, WSDOT added an auxiliary lane on southbound I-5 between Thorne Lane and Berkeley Street, as well as ramp meters in 2015 to improve operations along I-5 and at the interchanges. The City of Lakewood is planning for an additional improvement at Berkeley Street, as part of the *Madigan Access Improvement Project*, which will open in 2017 to address the Berkeley Street Interchange deficiencies.

The cloverleaf configuration of the Main Gate interchange does not have traditional intersections with traffic control devices, such as stop signs or traffic signals. To analyze the merge and diverge points on 41st Division Drive with the various I-5 ramps, output from the Meso Model was used to estimate average approach delays. A summary of these approach delays is shown in Table 2.

Based on a review of the estimated approach delays at the I-5 northbound ramps, the northbound approach along 41st Division Drive has an average delay of over five minutes per vehicle during the PM peak hour. The other approaches have delays of less than 30 seconds per vehicle. At the I-5 southbound ramps, the southbound approach along 41st Division Drive has an average delay of over three minutes per vehicle during the PM peak hour. The other approaches have delays of less than 30 seconds per vehicle. These long delays are caused by traffic congestion along the I-5 mainline, which backs up traffic on the on-ramps to their junction with 41st Division Drive.

Table 1: Summary of Interchange Delay and Level of Service (LOS) at the Reconfigured Interchanges and Other Area Interchanges

Reconfigured Interchanges Existing 2013			Other Area Interchanges Existing 2013		
Intersections	AM	PM	Intersections	AM	PM
<u>I-5 NB Ramps/Berkeley Street (Signal)</u>			<u>I-5 NB Ramps/Center Drive** (2-way Stop)</u>		
Average Delay (sec) / LOS	25.7/C	29.7/C	Average Delay (sec) / LOS	NA	40.8/E
<u>I-5 SB Ramps/Berkeley Street (Signal)</u>			<u>I-5 SB Ramps/Center Drive (2-way Stop)</u>		
Average Delay (sec) / LOS	69.2/E	54.0/D	Average Delay (sec) / LOS	13.9/B	12.7/B
<u>Berkeley St/Union Avenue (Signal)</u>			<u>Center Drive/Wilmington Drive (2-way Stop)</u>		
Average Delay (sec) / LOS	10.6/B	12.1/B	Average Delay (sec) / LOS	13.0/B	14.7/B
<u>I-5 NB Ramps/Thorne Lane (Signal)</u>			<u>I-5 NB Ramps/Steilacoom-DuPont Road (2-way Stop)</u>		
Average Delay (sec) / LOS	56.9/E	71.2/E	Average Delay (sec) / LOS	32.3/C	49.9/D
<u>I-5 SB Ramps/Thorne Lane (Signal)</u>			<u>I-5 SB Ramps/Steilacoom-DuPont Road (Signal)</u>		
Average Delay (sec) / LOS	58.7/E	49.1/D	Average Delay (sec) / LOS	18.8/B	27.3/C
<u>Thorne Lane/Union Avenue (4-way Stop)</u>			<u>Steilacoom-DuPont Road/Barksdale Avenue/ Wilmington Drive (Signal)</u>		
Average Delay (sec) / LOS	9.6/A	11.1/B	Average Delay (sec) / LOS	43.1/D	29.7/C
<i>NOTES:</i>			<u>I-5 NB Ramps/Gravelly Lake Drive (2-way Stop)</u>		
* - LOS values below "D" shown in bold font			Average Delay (sec) / LOS	39.8/D	70.3/E
** - Assumes new configuration of intersection built in 2015			<u>I-5 SB Ramps/Gravelly Lake Drive (Signal)</u>		
			Average Delay (sec) / LOS	41.9/D	47.3/D
			<u>Gravelly Lake Drive/Pacific Highway (Signal)</u>		
			Average Delay (sec) / LOS	25.5/C	29.0/C

Table 2: 2013 Delay Summary at Main Gate Interchange

Approach	NB I-5 Ramp / 41 st Division Drive		SB I-5 Ramp / 41 st Division Drive	
	Volume AM/PM	Delay (seconds per vehicle) AM/PM	Volume AM/PM	Delay (seconds per vehicle) AM/PM
NB on 41 st Division Drive	790/1,830	0.1/311	690/1,445	0.6/24.2
SB on 41 st Division Drive	1,335/1,195	0.4/26.1	1,095/1,375	1.1/188
EB on I-5 NB Off-ramp	285/120	0.0/0.0	420/225	0.9/23.4
WB on I-5 NB Loop Off-ramp	200/60	0.1/12.2	240/180	0.2/0.0

Note: Delay based on Mesoscopic Model Output

3.9 Summary of Existing I-5 Traffic Conditions in the JBLM vicinity

A summary of the key findings from the traffic operation analyses of the 2013 I-5 conditions includes:

- Traffic volumes along several sections of I-5 in the JBLM area are near or exceed the practical capacity of the highway.
- Travel speeds along several sections of I-5 are below 70 percent of the posted speed (LOS F) with some sections operating between 20 mph to 30 mph.
- These lower travel speeds also reduce the capacity of the I-5 corridor.
- Congestion along the I-5 corridor through the JBLM area can last 2 to 3.5 hours during the PM peak period.
- High levels of exiting and entering traffic from multiple, close-proximity ramps cause drivers to shift lanes frequently, resulting in slow travel speeds.
- The lack of reasonable alternative routes results in short, local trips on I-5 for travel between JBLM and local communities, and between land-locked neighborhoods and other nearby destinations.
- Approximately 12 percent of the drivers wishing to use I-5 cannot use it during the PM peak hour and must travel at other times.
- Several of the ramp terminal intersections currently operate below LOS D.

4.0 Future Year Transportation System Assumptions

Over the next 25 years, traffic along the I-5 corridor through the JBLM area is expected to grow and congestion to increase as speeds along I-5 slow. To address this expected growth, WSDOT and local agencies have developed their transportation plans and have selected short-term improvement projects planned for implementation over the next six years. The 2020 and 2040 No-Build transportation system includes the existing transportation network plus these funded projects, outlined in the local agencies' Transportation Improvement Plans (TIPs) and WSDOT's State Transportation Improvement Plan (STIP), as well as funded JBLM improvements. These highway improvements, located in or near the study area, include:

- I-5 Congestion Management TIGER III: Southbound auxiliary lanes from Thorne Lane to Berkeley Street.
- I-5 Congestion Management TIGER III: Ramp metering, traffic cameras, and variable message signs (See Figure 12).
- Point Defiance Bypass Rail project improvements¹.

¹ Point Defiance Bypass Project – Transportation Discipline Report, WSDOT, September, 2012

- Madigan Gate Access Improvements (See Figure 13).
- Center Drive northbound ramp intersection improvements.
- Joint-Base Connector Phase 1 improvements, including the closure of the Rainer Gate.
- Integrity Gate and Mounts Gate opened with full access and closed the I-Street Gate.

Figure 13: Interim Improvements Using Federal Grant Funding



Figure 12: Access Improvements to Madigan Gate

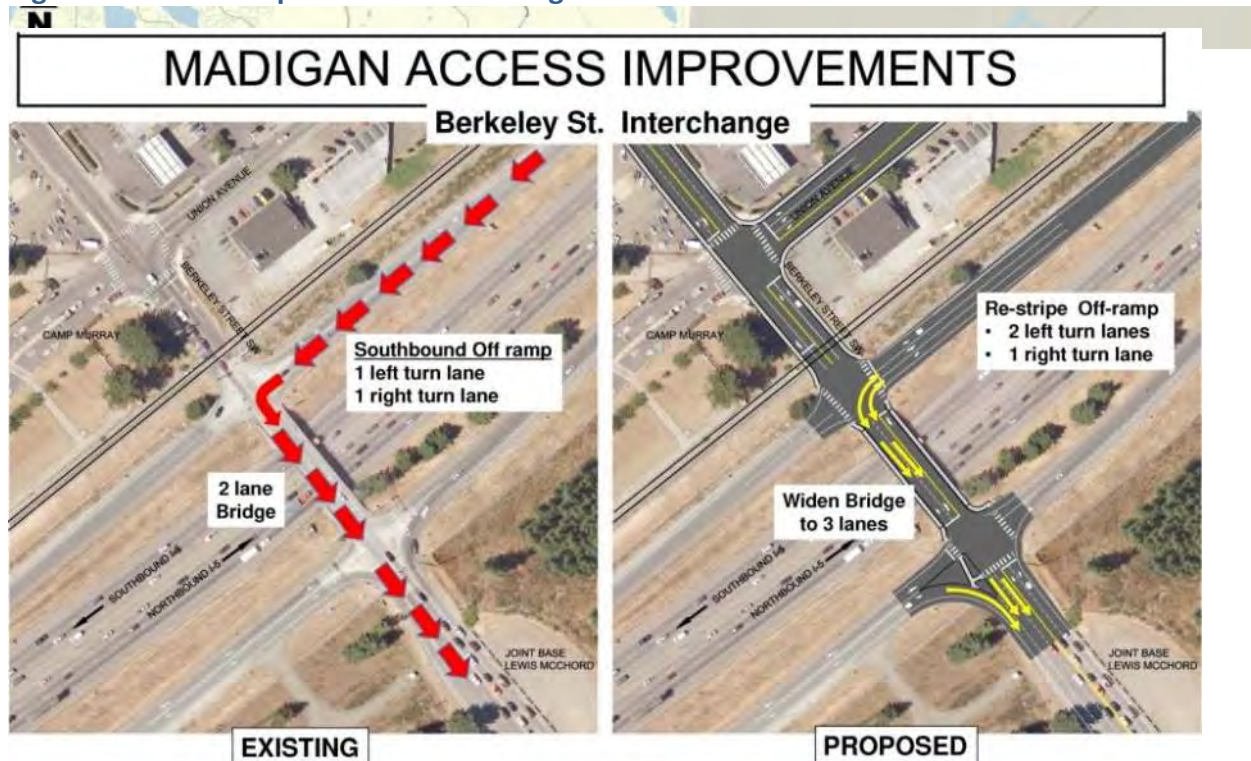

5.0 Traffic Forecasting Modeling Process and Assumptions

The travel forecasts for the *I-5 JBLM Vicinity Congestion Relief Study* were developed using a series of inter-related and complimentary modeling tools that included a Macroscopic (Macro) Model, Mesoscopic (Meso) Model and Transit Sketch Planning (Transit) Model. Each of the three modeling tools was developed specifically for the *I-5 JBLM Vicinity Congestion Relief Study* and were used to evaluate the No Build and Build Alternatives. More extensive information is available in that study, while the following is a general description of each model and how they were integrated for the project.

5.1 Macroscopic Model

The I-5 JBLM Macro Model was used to develop travel forecasts in the study area and to understand travel pattern changes that would result from various improvement alternatives. The Macro Model has a base year of 2013, and two forecast horizon years of 2020 (opening year) and 2040 (design year). The model area includes Pierce County south of the Puyallup River and northern Thurston County. The model includes trip assignments for both high-occupancy vehicle (HOV) and single-occupancy vehicle (SOV) mode splits for two time periods: AM peak period (6 AM to 9 AM), and PM peak period (3 PM to 6 PM). The Macro Model is consistent with local land use plans, and the Puget Sound Regional Council (PSRC) and Thurston Regional Planning Council (TRPC) regional models.

5.2 Transit Sketch Planning Model

The Transit Model was developed to provide a more comprehensive, multimodal assessment of how corridor level improvements can help achieve the congestion reduction goals of the project. The Transit Model captured the effects that commuter-oriented transportation demand management programs (subsidized transit passes, vanpools, shuttles, etc.), investments in high-occupancy vehicle facilities, and improvements to commuter transit service can have on congestion in the corridor. Using the Transit Model in the planning process also allowed the project team to better understand the commuter transit market in this corridor.

The Transit Model was designed to build on the existing Macro Model while also integrating with the Meso Model. The Transit Model used data from the established regional models, as well as data that had been identified through industry research as important for forecasting commuter transit ridership.

The Transit Model was integrated into the overall modeling process, interfacing directly with the Macro Model. A variety of data inputs from the Macro Model fed into the Transit Model including SOV and HOV travel times. Once transit ridership forecasts for each alternative were developed, the data were input back into the Macro Model to account for the changes in mode share.

Ridership forecasts were also used directly in performance assessments of the improvement alternatives.

5.3 Mesoscopic Model

The I-5 JBLM Meso Model was developed to evaluate a series of detailed transportation performance measures that could be used to compare each of the improvement alternatives. The Meso Model was built using Dynameq software and is based upon the Macro Model, so it is also consistent with local and regional land use plans and regional transportation models. The general analysis area of the Meso Model is the I-5 corridor between SR 512 and SR 510, including the adjoining local on-JBLM and off-JBLM arterials. The Meso Model incorporates specific roadway and intersection operational details, such as signal timing, roadway channelization, ramp metering, and merging/weaving conflicts along the I-5 mainline. It also includes operational impacts from at-grade railroad crossings and military gate operations. These features enable the Meso Model to dynamically balance traffic volumes as the various alternative routes become congested.

The Meso Model has a base year of 2013 and two forecast horizon years of 2020 and 2040. The model includes trip assignments for both high-occupancy vehicle (HOV) and single-occupancy vehicle (SOV) modes for two time periods: AM peak period (5 AM to 11 AM) and PM peak period (2 PM to 8 PM). The 6-hour time periods provide the opportunity to evaluate impacts from increased congestion and peak spreading already occurring along the I-5 corridor.

5.4 Modeling Procedure

Outputs from the modeling effort were coordinated between the three different models. Figure 14 illustrates the general procedure for modeling each alternative. Step 1 included coding the Macro Model with the assumptions inherent in the improvement alternative, running the model, and outputting SOV and HOV travel time trip tables for use in the Transit Sketch Model. Step 2 included coding the Transit Sketch Model with the improvement alternative's assumptions, running the model, and outputting transit ridership and vehicle trip adjustments (changes in amount of vehicle trips due to changes in transit ridership) for use back in the Macro Model. Step 3 included revising the Macro Model with the transit ridership adjustments, re-running the model, and outputting vehicle volume metrics and subarea trip tables for use in the Meso Model. The final step, Step 4, included detailed operational coding of the Meso Model, running the model, and then outputting various performance metrics, such as travel volumes, speeds, times and hours of congestion and mode shares.

Figure 14: Model Process Flowchart

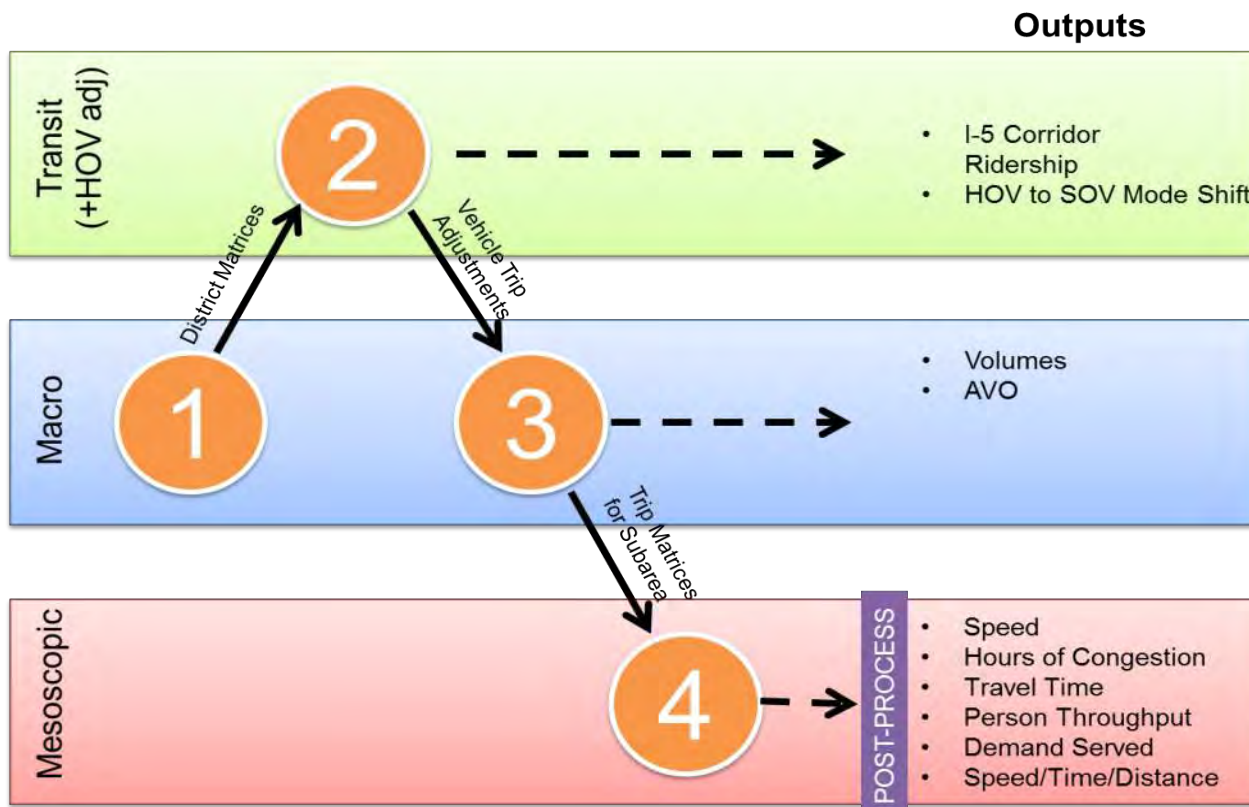

6.0 2020 and 2040 I-5 No Build Alternative Traffic Analysis

The following section summarizes the base traffic operations along I-5 for an opening year (2020) and a design year (2040) time frame. Synchro software is used to analyze signalized and non-signalized intersections; Sidra software is used to analyze roundabout operations; and SimTraffic and the Meso Model are used to simulate and analyze traffic operations along the I-5 mainline and at interchanges.

6.1 Future No Build Alternative I-5 Traffic Volumes

The forecasted No Build Alternative traffic volumes along I-5 for both the AM and PM peak hours, are shown in Figures 15 and 16, respectively. In 2020, the two-way traffic volume along I-5 between Center Drive and Gravelly Lake Drive ranges from approximately 8,200 to nearly 11,000 vehicle trips in the AM peak hour and from 7,400 to nearly 11,000 vehicle trips in the PM peak hour. In 2040, the two-way traffic volume along I-5 ranges from approximately 8,600 to 11,200 vehicle trips in the AM peak hour and from 7,200 to nearly 10,100 vehicle trips in the PM peak hour.

Figure 15: 2020 and 2040 AM Peak Hour Volumes on I-5 – No Build Alternative

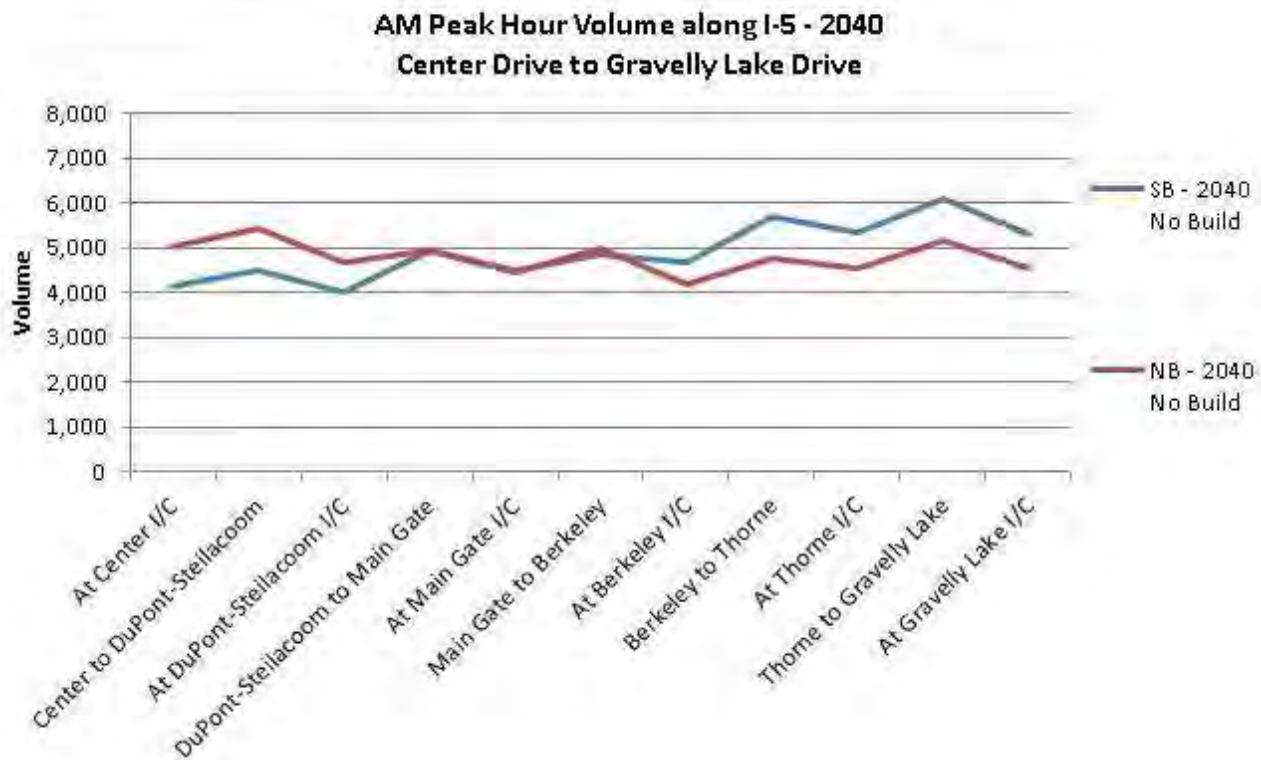
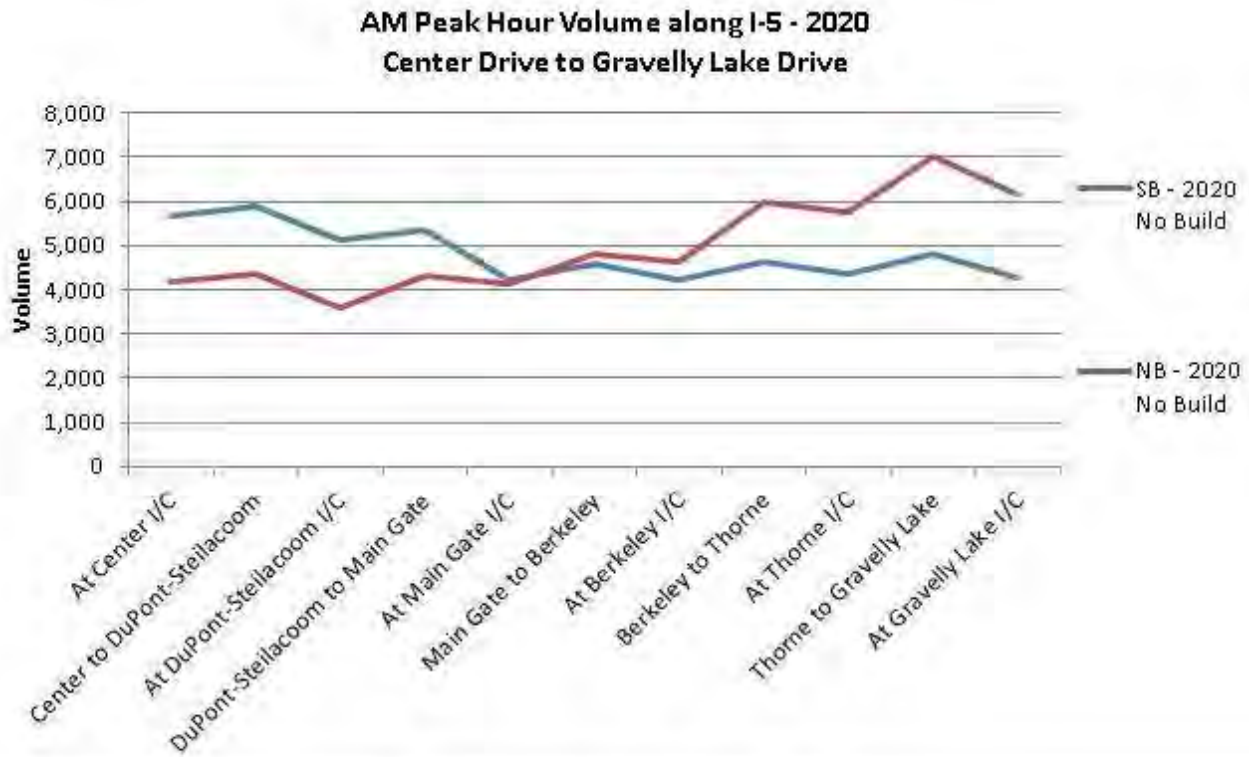
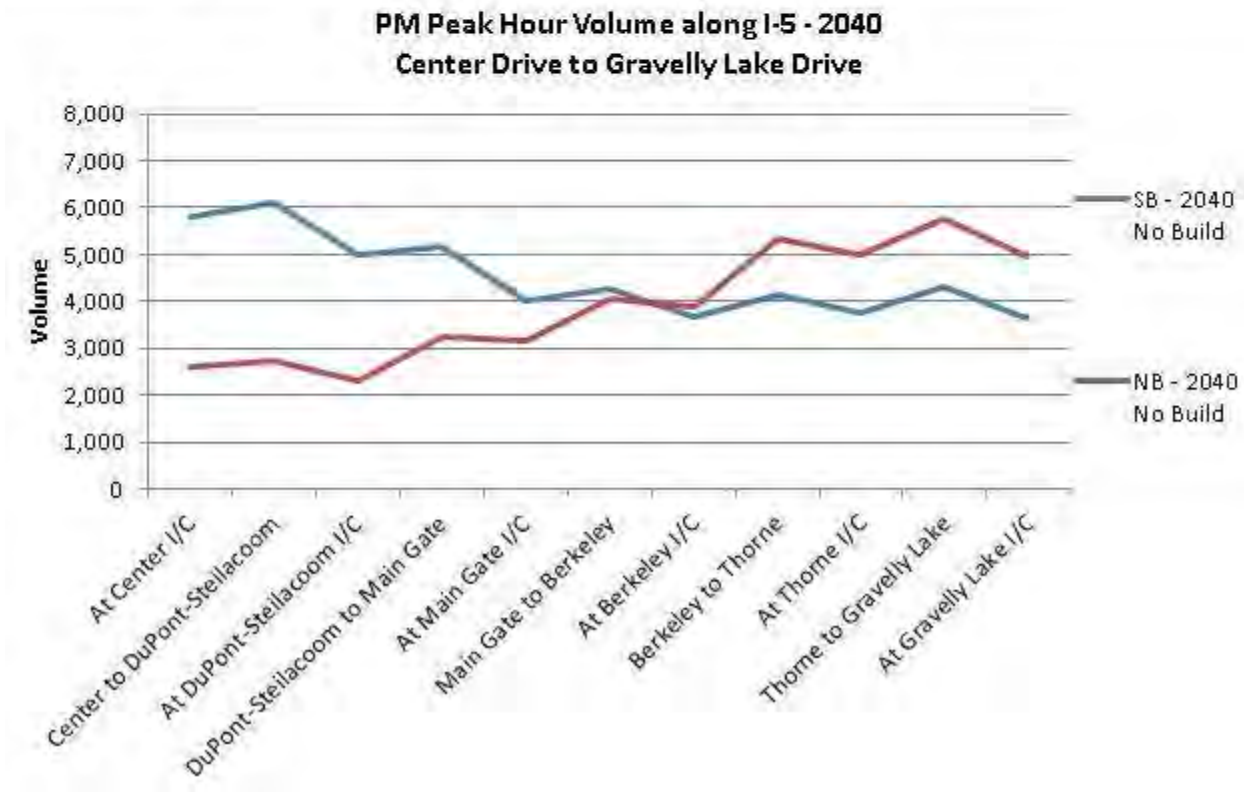
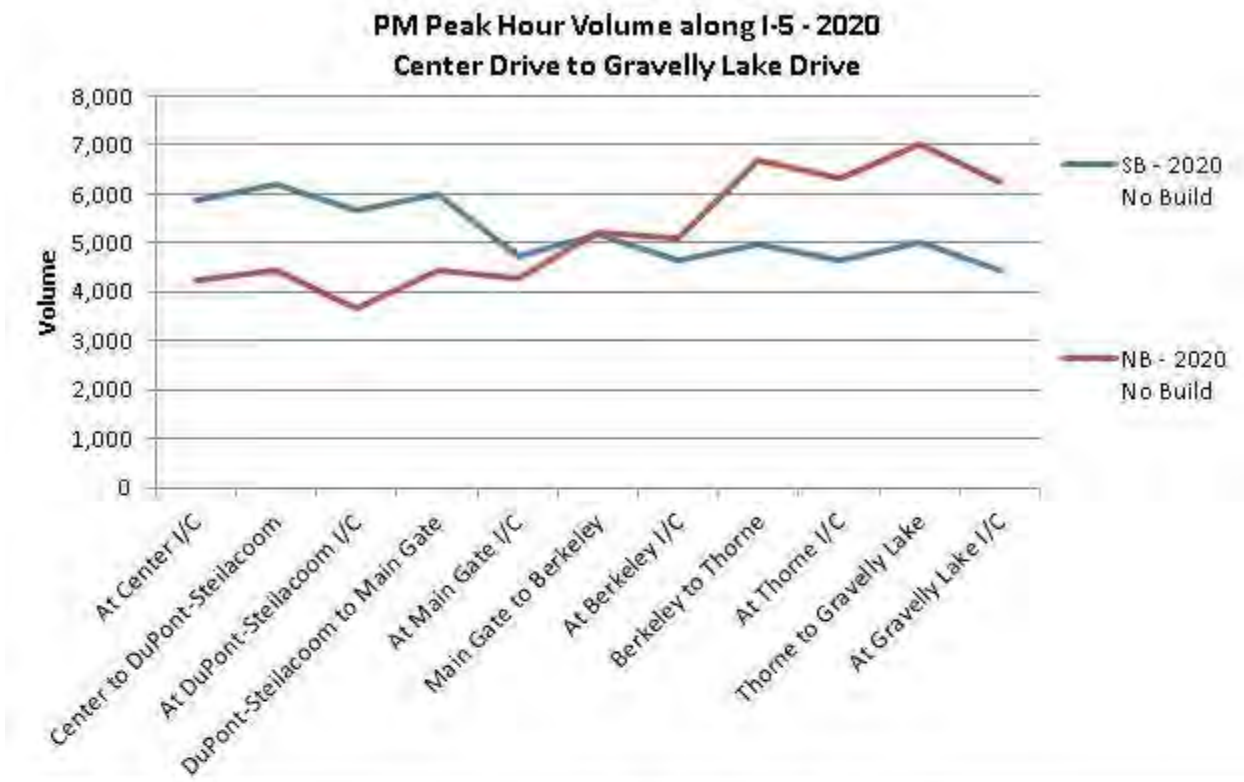

Figure 16: 2020 and 2040 PM Peak Hour Volumes on I-5 – No Build Alternative



The lower number of PM vehicle trips along I-5 as compared to the AM vehicle trips is because of the slower travel speeds in the PM which reduces the number of vehicles than can actually use the I-5 corridor during the PM peak hour. The small growth in vehicle trips along I-5 between 2020 and 2040 in the AM peak hour and the decrease in vehicle trips in the PM peak hour are also because of the reduction in average travel speeds, caused by the increased congestion, resulting in trips being diverted to other travel departure times.

6.2 Average Daily Traffic along the I-5 Mainline

Using the 2020 and 2040 land use assumptions, the travel demand/operational modeling tools were used to estimate Average Daily Traffic (ADT) and peak period volumes for 2020 and 2040 with the No Build and Build Alternatives. A summary of the estimated daily traffic growth on I-5 from the Center Drive interchange and the Gravelly Lake Drive interchange is shown in Table 3. Due to the congestion along I-5 and the reduced number of travel lanes south of Thorne Lane, the No Build Alternative would attract fewer vehicles to the corridor and results in lower growth than the Build Alternative that includes added capacity. Depending on location, existing traffic volumes are projected to increase by approximately 0.8 percent to 1.4 percent per year over the long-range planning horizon (2040). A detailed summary of peak hour and ADT volumes is listed in Appendix D.

Table 3: Daily Traffic Growth on I-5 in the JBLM Vicinity

		2-Way Average Daily Traffic Volumes on I-5 in Vicinity of JBLM							
Scenario	Center Drive	Stellacoom-DuPont Road	41st Division Drive	Berkeley Street	Thorne Lane	Gravelly Lake Drive			
2013 Existing	122,000	124,000	120,000	129,000	137,000	146,000			143,000
2020 No Build	135,900	132,600	130,000	138,000	149,700	159,100			154,900
2020 Build Alt	135,700	137,300	141,800	154,400	168,900	167,300			158,800
2040 No Build	164,600	152,700	149,600	154,200	165,800	181,800			171,100
2040 Build Alt	165,600	158,900	170,100	183,900	195,000	192,000			176,600

6.3 2020 and 2040 No Build Alternative Travel Demand along I-5

In 2013, 99 percent of the AM peak hour demand for travel on I-5 was accommodated and just over 88 percent of the PM peak hour was able to operate on I-5, based on person miles of travel from the Meso Model. By 2020, the ability of the No Build Alternative to meet AM peak hour

demand is expected to about 94 percent, and by 2040 it would continue to drop to about 74 percent. During the PM peak hour, the travel demand that could be accommodated on I-5 with the No Build Alternative is forecast to drop to about 71 percent in 2020, and to about 30 percent by 2040. Increased congestion along I-5 through the JBLM area prevents drivers who want to travel on I-5 from using it during peak travel times.

The traffic volume forecasts discussed in the preceding paragraphs and highlighted in Table 3 represent expectations of the level of traffic that would use I-5 in the study area in 2020 and 2040. This differs from the level of traffic that would *like* to use the corridor during these time periods. A key performance measure for understanding the impact of congestion on the I-5 corridor involves assessing the amount of travel demand that could be accommodated during the PM (highest) peak hour. This subsection discusses the ability of the No Build and Build Alternatives to meet demand for travel in the corridor in 2013, 2020 and 2040.

PM Peak Hour – As shown in Figure 17, the level of demand for travel on I-5 during the PM peak hour is substantively higher than what could actually be accommodated with either the No Build or Build Alternatives. As indicated by the data in this figure, the No Build Alternative would accommodate less travel demand on I-5 than 2013 conditions during the PM peak hour. In 2020, the No Build Alternative would accommodate approximately 70 percent of demand, while in 2013 slightly more than 88 percent of demand was met. By 2040, the No Build Alternative would accommodate about 30 percent of the PM peak hour demand. This finding is a useful indicator of the duration of congestion which would not only affect the PM peak hour, but would likely spread into the hours adjacent to the peak. The greater the percentage of travel demand that cannot be met in a single peak hour, the greater the total number of hours of peak period congestion that would be expected.

Figure 17: 2020 and 2040 Met and Unmet Travel Demand on I-5 during PM Peak Hour

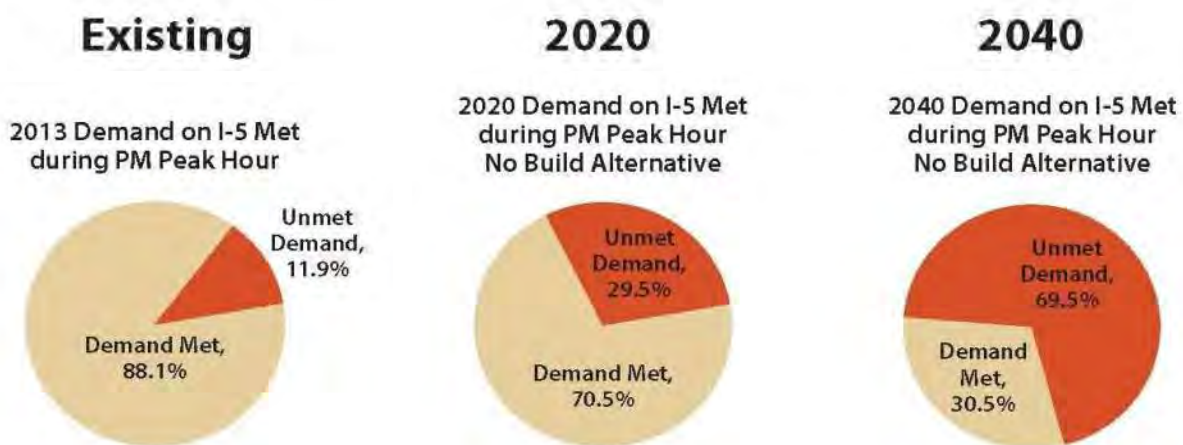

*Demand based on person miles of travel estimate from Mesoscopic travel model.

PM Peak Three Hours – While over 88 percent of existing demand during the single 2013 PM peak hour can be accommodated in the corridor, Figure 16 shows that nearly everyone who wanted to travel on I-5 in 2013 could make the journey at some point during the three hour PM peak period. Only one percent of all PM peak three hour demand could not be satisfied during this time period. Figure 18 also shows that as demand grows to 2020, over 90 percent of demand could be accommodated with the No Build Alternative. By 2040, less than 72 percent of demand could be accommodated by the No Build Alternative during the three-hour PM peak period.

Figure 18: 2020 and 2040 Met and Unmet Demand on I-5 during PM Peak 3-hours

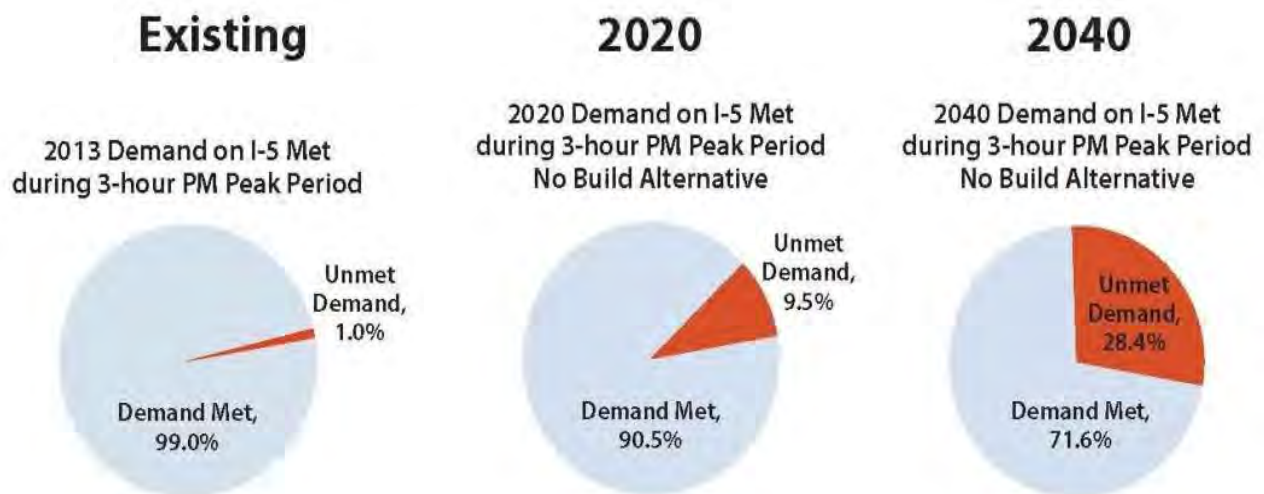

*Demand based on person miles of travel estimate from Mesoscopic travel model.

6.4 Average 2020 and 2040 I-5 Travel Speeds

Predicted average travel speeds along the I-5 corridor in 2020 and 2040 for the AM peak hour are illustrated in Figure 19. As can be observed from the figure, 2020 and 2040 AM peak hour northbound travel speeds along I-5 would be around the posted speed of 60 mph north of Center Drive. In the southbound direction, travel speeds are expected to fall below 42 mph or LOS F north of Thorne Lane. These slow speeds would be attributed to the reduction in the number of travel lanes from four lanes to three lanes, requiring drivers to merge. This slows traffic and causes back-ups north of this choke point.

Figure 20 illustrates expected travel speeds during the 2020 and 2040 PM peak hours. As shown in this figure, 2020 and 2040 PM peak hour northbound travel speeds would be below 42 mph or LOS F, with some sections below 10 mph. The only exception is north of Thorne Lane where speeds are

expected to return to near the posted speed limit, because the number of travel lanes increase from three to four lanes. Figure 21 presents projected PM peak hour travel speeds visually.

Figure 19: 2020 and 2040 AM Peak Hour Average Travel Speeds on I-5 – No Build Alternative

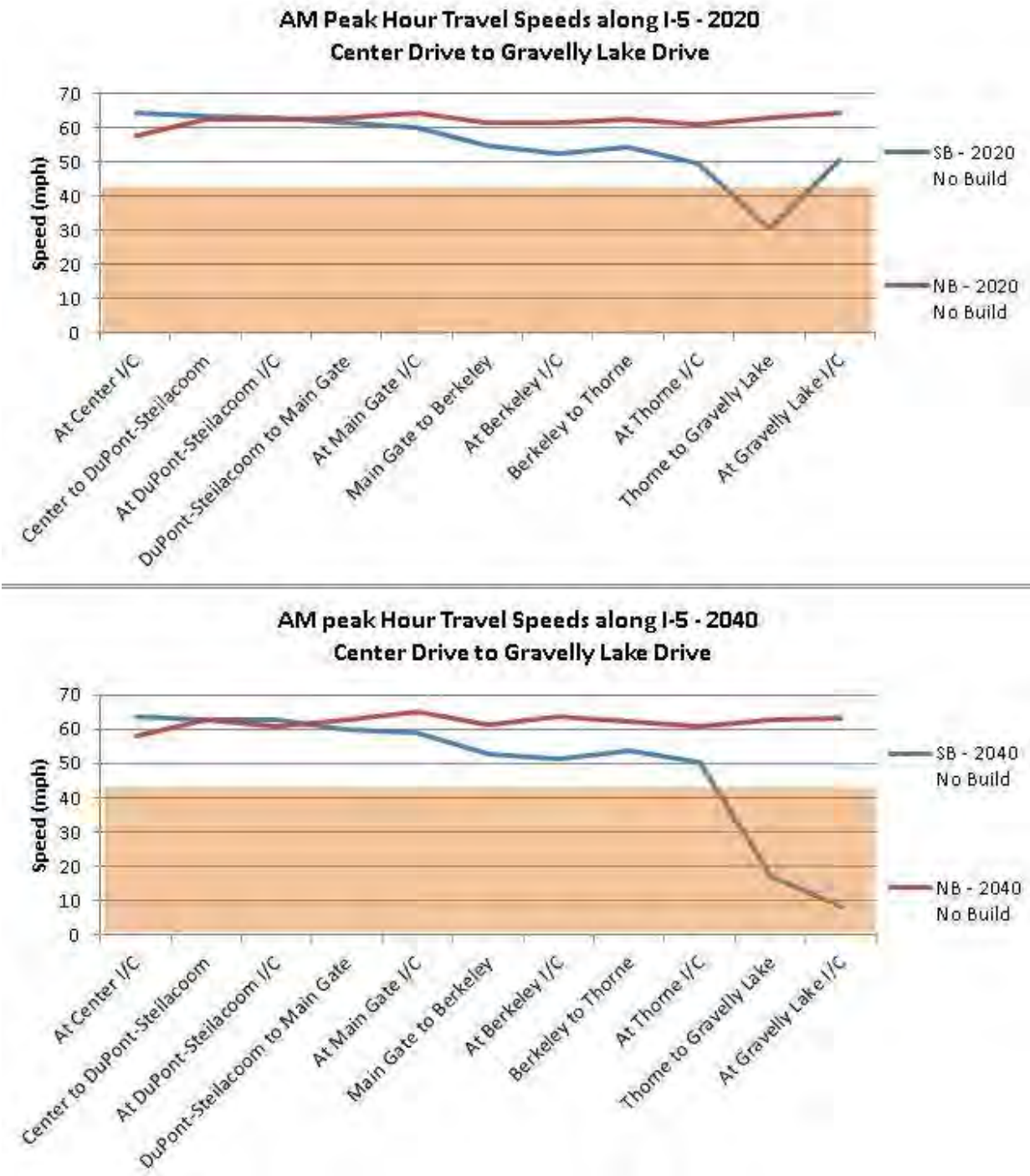

Figure 20: 2020 and 2040 PM Peak Hour Average Travel Speeds on I-5 – No Build Alternative

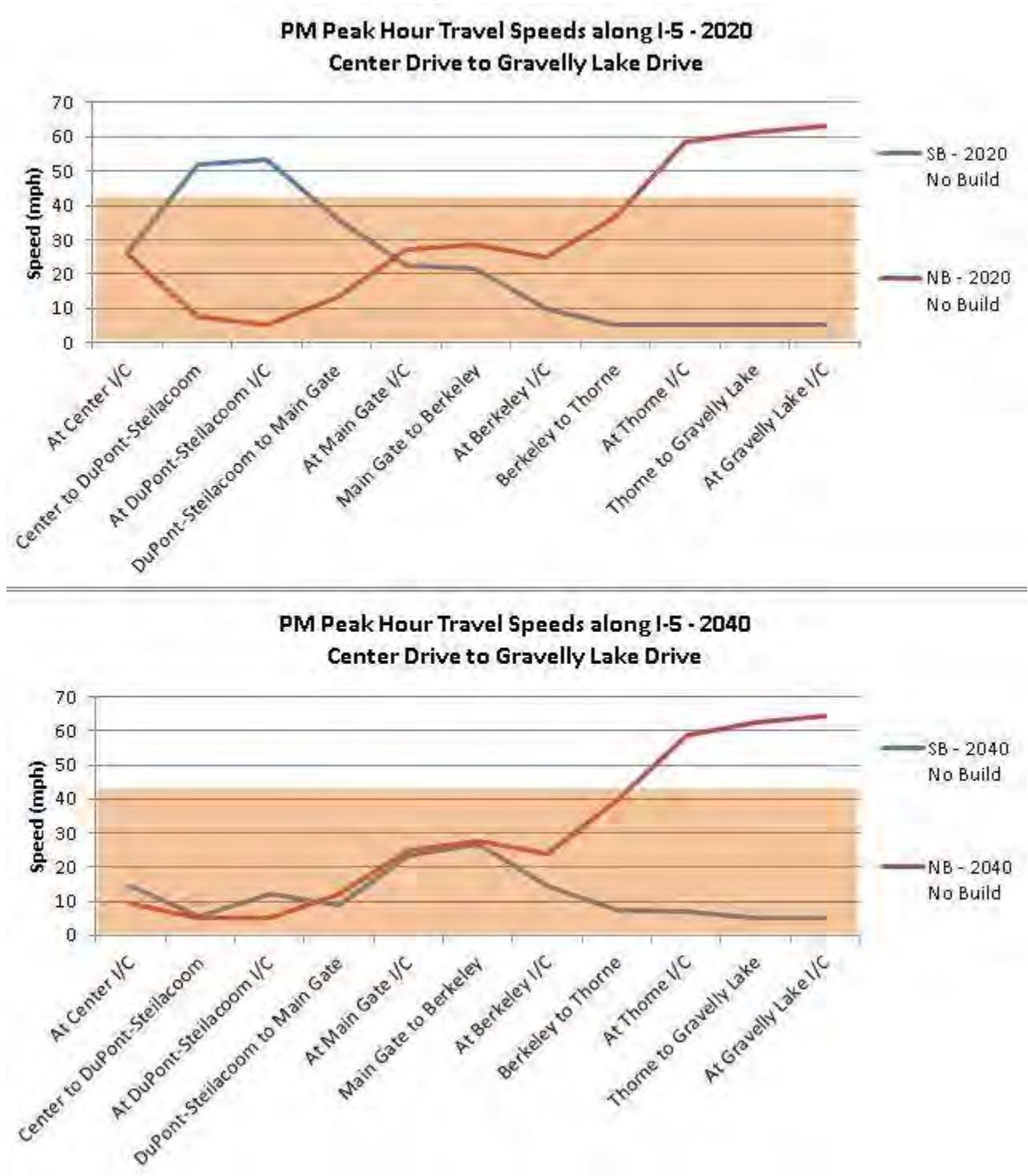
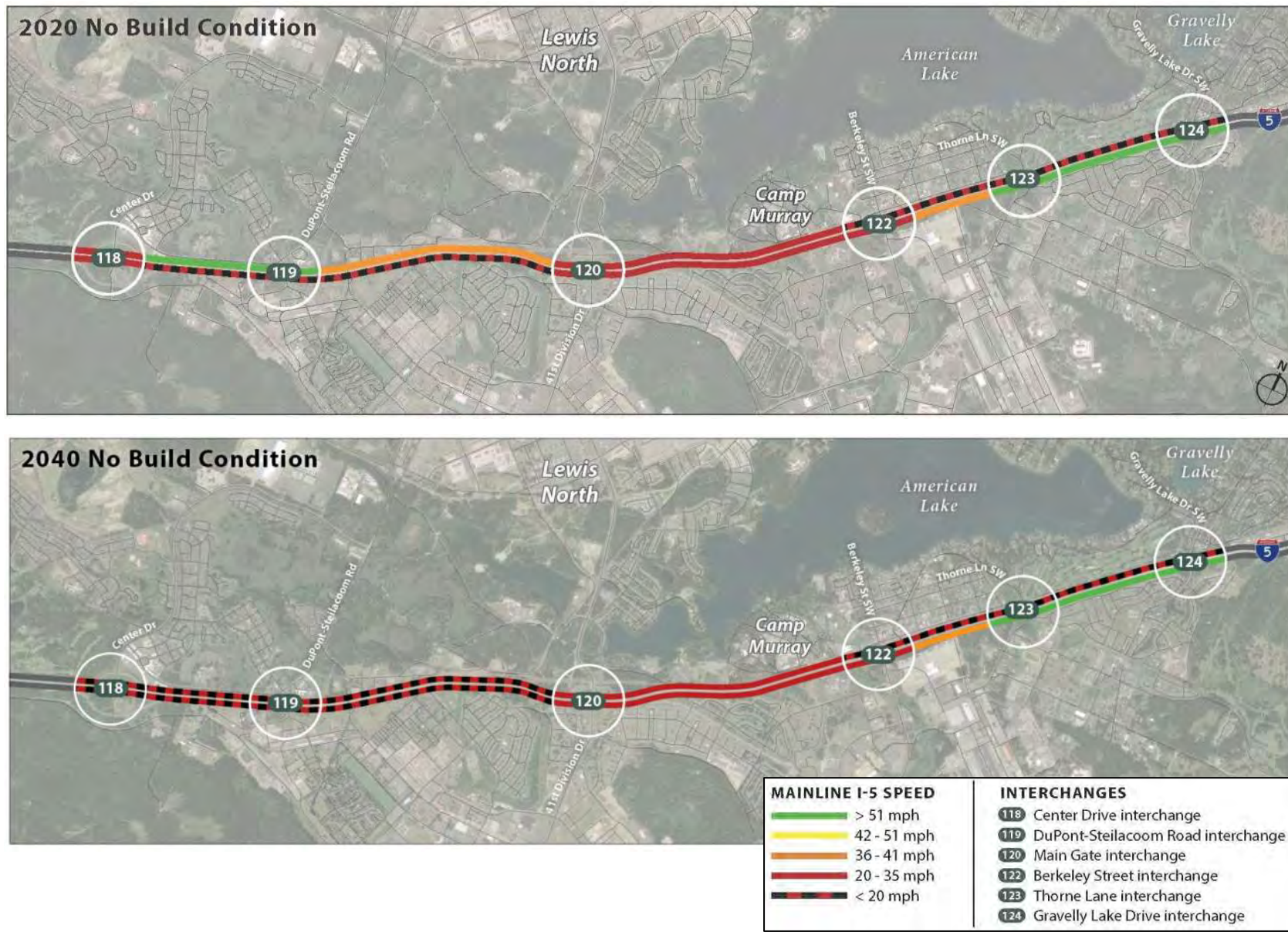

Figure 21: 2020 and 2040 PM Peak Hour Travel Speeds on I-5 between Center Drive and Gravelly Lake Drive – No Build Alternative



In the southbound direction during 2020, PM peak hour travel speeds would be generally below 42 mph or LOS F, except for a short section between Steilacoom-DuPont Road and Center Drive where traffic speeds are expected to increase to around 50 mph as traffic volumes stabilize. During 2040 southbound travel speeds on I-5 between Gravelly Lake Drive and Center Drive are expected to be less than 30 mph with some sections at 10 mph or below. These slow average PM speeds signify severe congestion with slow moving vehicles and periods of stop-and-go traffic.

6.5 2020 and 2040 Hours of Congestion along I-5

Based on the Mesoscopic Model data, estimates were made of the number of hours the travel speed operated below 70 percent of posted speed or 42 mph in 2020 and 2040. Based on the analysis, less than one hour of congestion north of Thorne Lane is expected to occur southbound during the AM peak period in 2020. By 2040, the congestion north of Thorne Lane is expected to increase to 3.5 hours during the AM peak period.

During the PM peak period in 2020 and 2040, several hours of congestion occur along I-5 between Center Drive and Gravelly Lake Drive, as illustrated in Figure 22. These hours of congestion could last around four hours in 2020 and over five hours by 2040 in both the northbound and southbound directions.

The travel speed diagrams, illustrated in Figure 23, show that these slow average speeds and hours of congestions during the PM peak period extend between 2:00 PM and 8:00 PM and beyond. These diagrams show that there are several areas that speeds fall below 42 mph. In 2020, the southbound congestion generally extends north of the Main Gate Interchange with some congestion associated with the heavy on-ramp traffic at Center Drive. The northbound congestion in 2020 is south of Thorne Lane where the number of travel lanes increase from three lanes to four lanes. By 2040, congestion extends past the 8:00 PM analysis period and would geographically extend both north and south of the study area.

6.6 2020 and 2040 On- and Off-Ramp No Build Alternative Volumes along I-5

On- and Off-ramp volumes along I-5 between Center Drive and Gravelly Lake Drive remain high in 2020 and 2040. A comparison of the 2020 and 2040 AM peak hour on- and off-ramp volumes is shown in Figure 24. Overall, ramp volumes generally decrease in 2040 over the 2020 volumes during the peak hour because of increased congestion along I-5.

Similarly, in 2040 AM peak hour, there are about 3,660 vehicles exiting I-5 and 2,070 vehicles entering I-5 at these seven interchanges southbound and about 3,450 vehicles exiting I-5 and 3,040 vehicles entering I-5 northbound. Again, the total of trips entering and exiting I-5 continues to be more than the capacity of a single lane, requiring drivers to shift lanes.

Figure 22: Hours of Congestion on I-5 during 2020 and 2040 PM Peak Periods from Center Drive to Gravelly Lake Drive – No Build Alternative

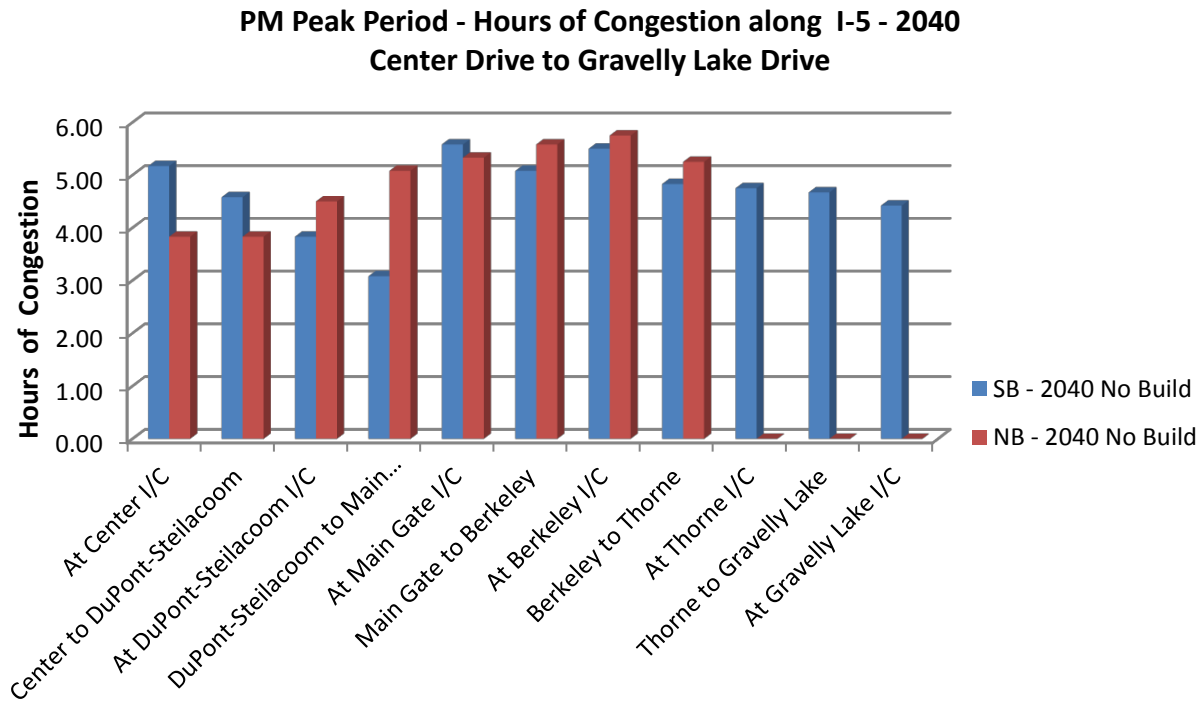
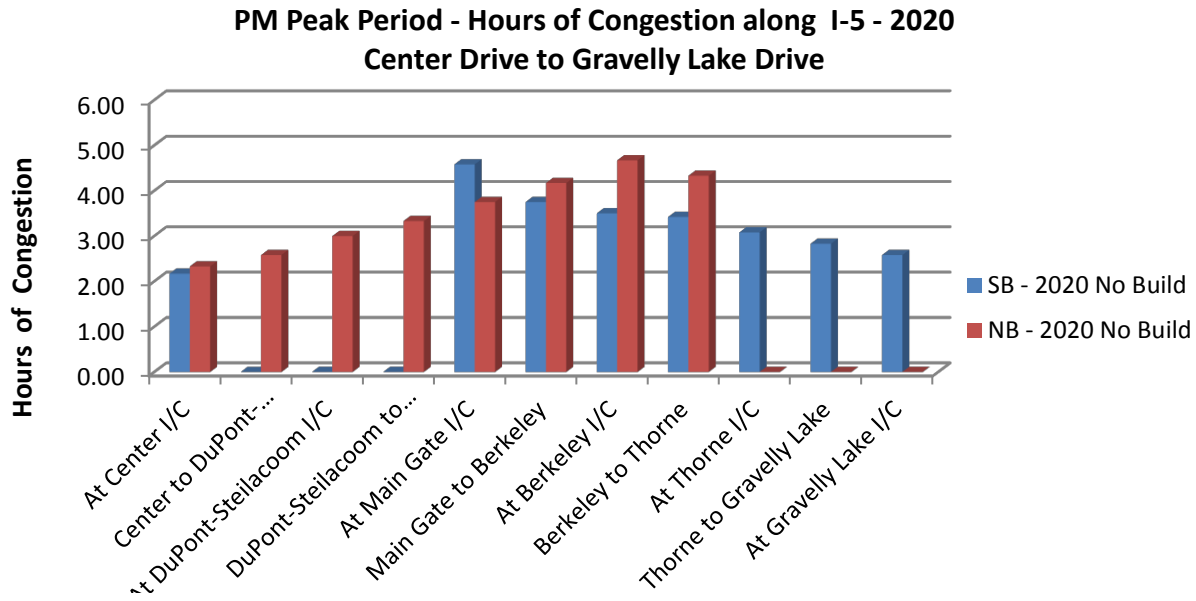
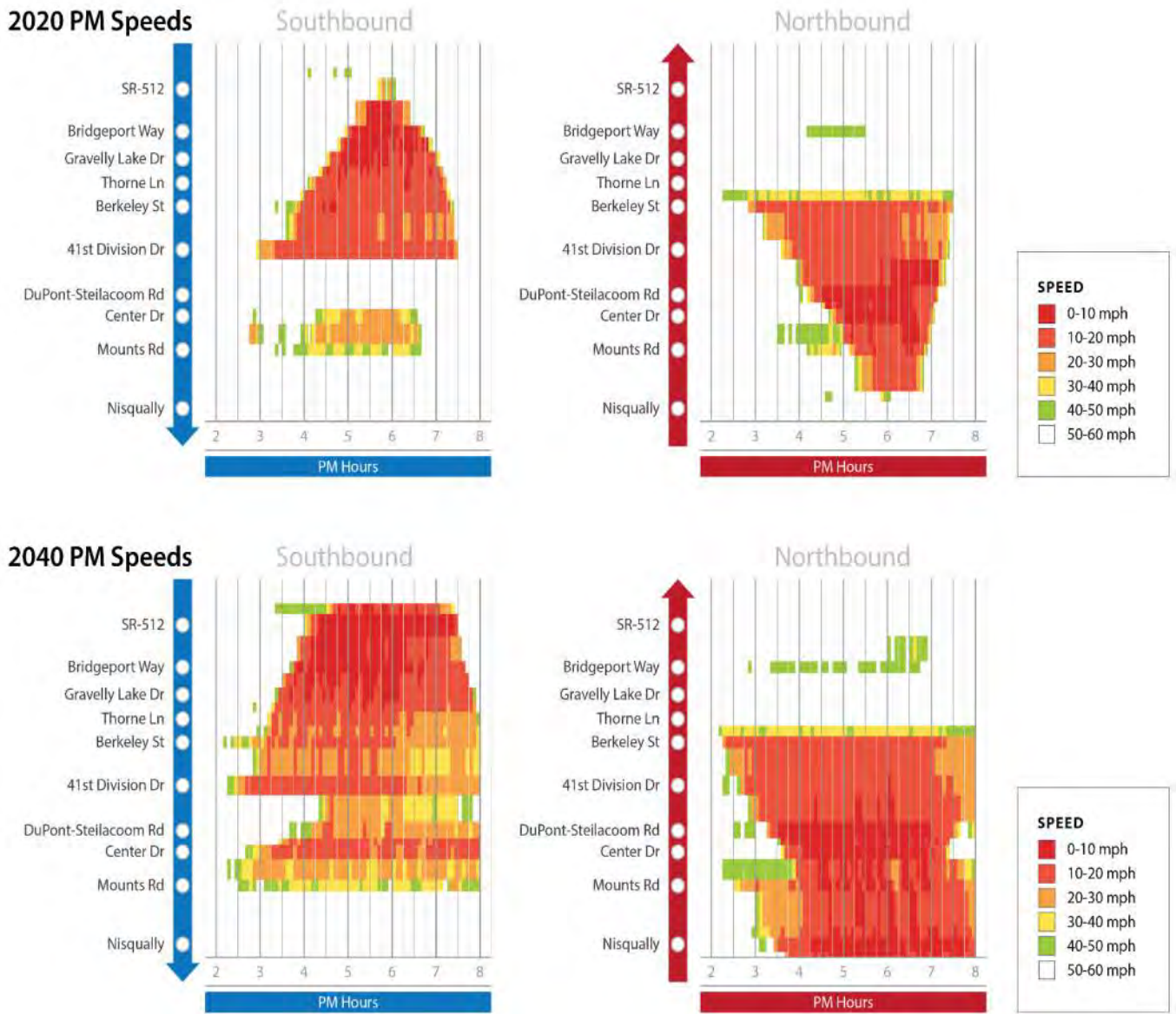

Figure 23: Travel Speeds on I-5 during the 2020 and 2040 PM Peak Period – No Build Alternative



A comparison of the PM peak hour on- and off-ramp volumes in 2020 and 2040 is shown in Figure 25. Overall at the six interchanges along I-5 in the study area in 2020, there are a total of about 2,300 vehicles exiting I-5 and 4,370 vehicles entering I-5 southbound, and about 2,640 vehicles exiting I-5 and 4,760 vehicles entering I-5 northbound.

Figure 24: 2020 and 2040 AM On- and Off-Ramp Volumes on I-5 from Center Drive to Gravelly Lake Drive – No Build Alternative

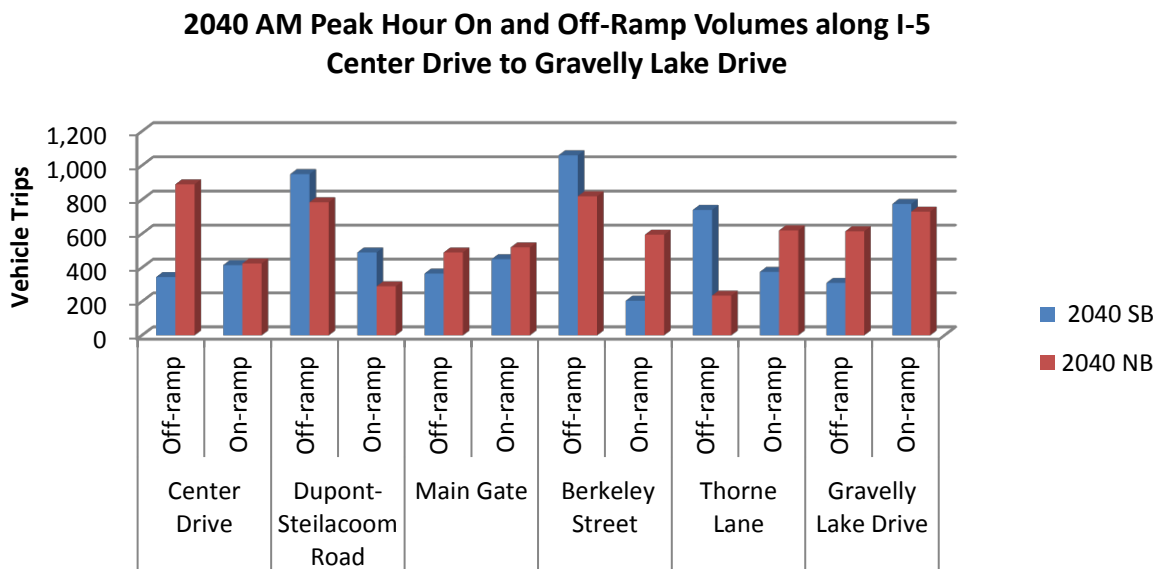
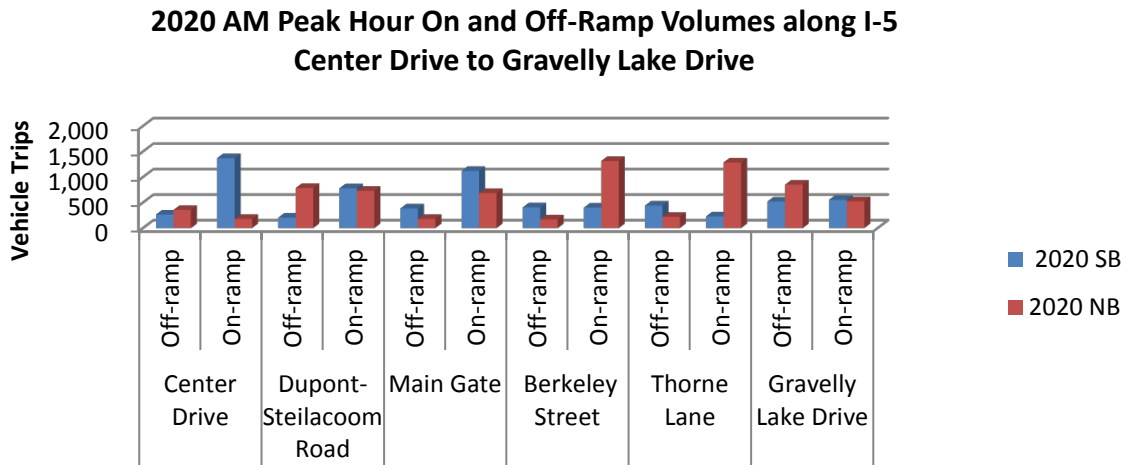
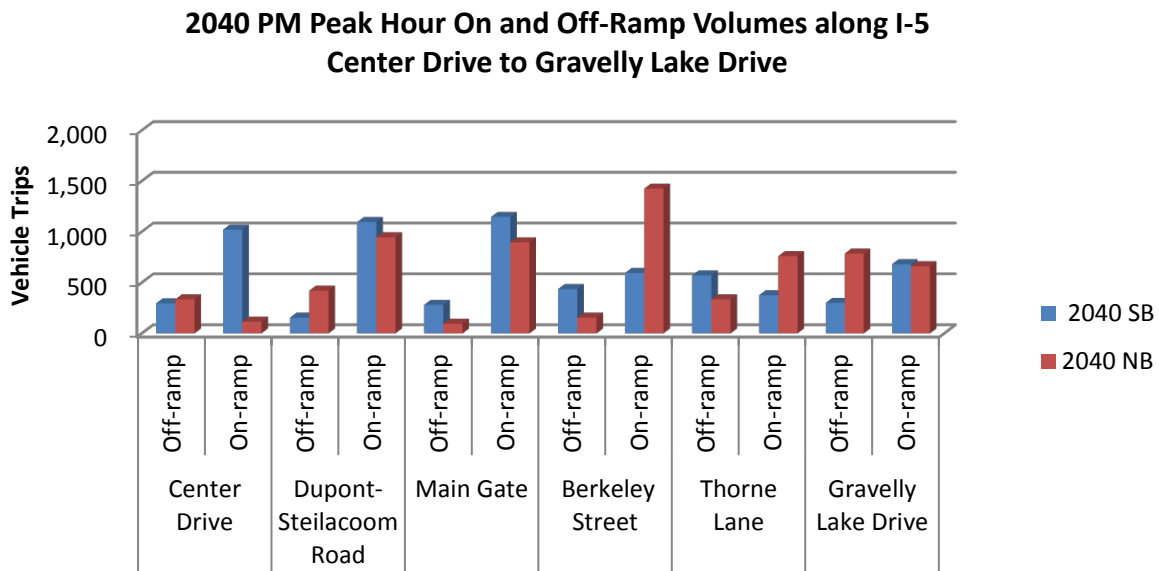
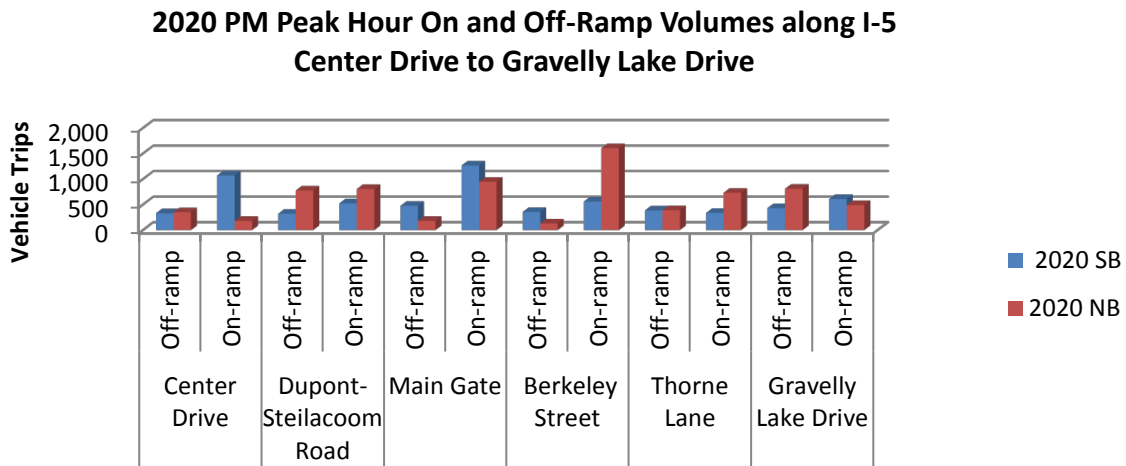

Figure 25: 2020 and 2040 PM On- and Off-Ramp Volumes on I-5 from Center Drive to Gravelly Lake Drive – No Build Alternative



Similarly, in 2040 during the PM peak hour, there are about 2,210 vehicles exiting I-5 and 4,500 vehicles entering I-5 at these six interchanges southbound and about 2,220 vehicles exiting I-5 and 4,740 vehicles entering I-5 at these six interchanges northbound

All of this traffic cannot be in the outside lane at the same time, so drivers frequently change lanes to enter and exit I-5. This heavy amount of lane change movement causes traffic to slow, increases congestion, and reduces the overall traffic throughput in the JBLM area.

6.7 Comparison of I-5 No Build Alternative Travel Times

A comparison of No Build Alternative travel times along I-5 between Center Drive and Gravelly Lake Drive was made using output from the Meso Model. As shown on Figure 26, drivers traveling southbound on I-5 during the AM peak period would generally operate near or at the posted speed limit in 2013 and 2020 and take about nine minutes. By 2040, southbound travel time would increase to about 12 minutes in the northbound direction in 2013, drivers operated about the posted speed and take around 8.1 minutes to travel between Center Drive and Gravelly Lake Drive. In both 2020 and 2040, the No Build Alternative northbound travel time would increase to about nine minutes during the AM peak hour.

During the PM peak period, 2013 southbound travel times along I-5 between Center Drive and Gravelly Lake Drive were estimated at about 15 minutes with no accidents, while in the northbound direction, it would take drivers about 12 minutes. By 2020, No Build Alternative southbound PM travel times are expected to increase to around 37 minutes, while it would take northbound drivers about 26 minutes to travel between Center Drive and Gravelly Lake Drive.

Figure 27 plots the travel time data in the northbound direction. In the northbound direction, 2040 No Build Alternative PM peak hour travel times are expected to increase to about 34 minutes between Center Drive and Gravelly Lake Drive. In the southbound direction, 2040 No Build Alternative PM peak hour travel times are expected to increase to about 48 minutes during the peak hour. The southbound 2040 PM Peak hour travel time between Thorne Lane and Main Gate is expected to be slightly better than the 2020 travel time because of a bottleneck at SR 512 which is limiting the amount of traffic that can travel southbound in 2040 and allows some drivers to temporarily speed up in this area. In 2020, the SR 512 bottleneck is less restrictive than in 2040 so more traffic can get through which reduces travel speeds between Thorne Lane and Main Gate.

Figure 26: Comparison of Southbound Cumulative Travel Times during AM and PM Peak Hours – No Build Alternative

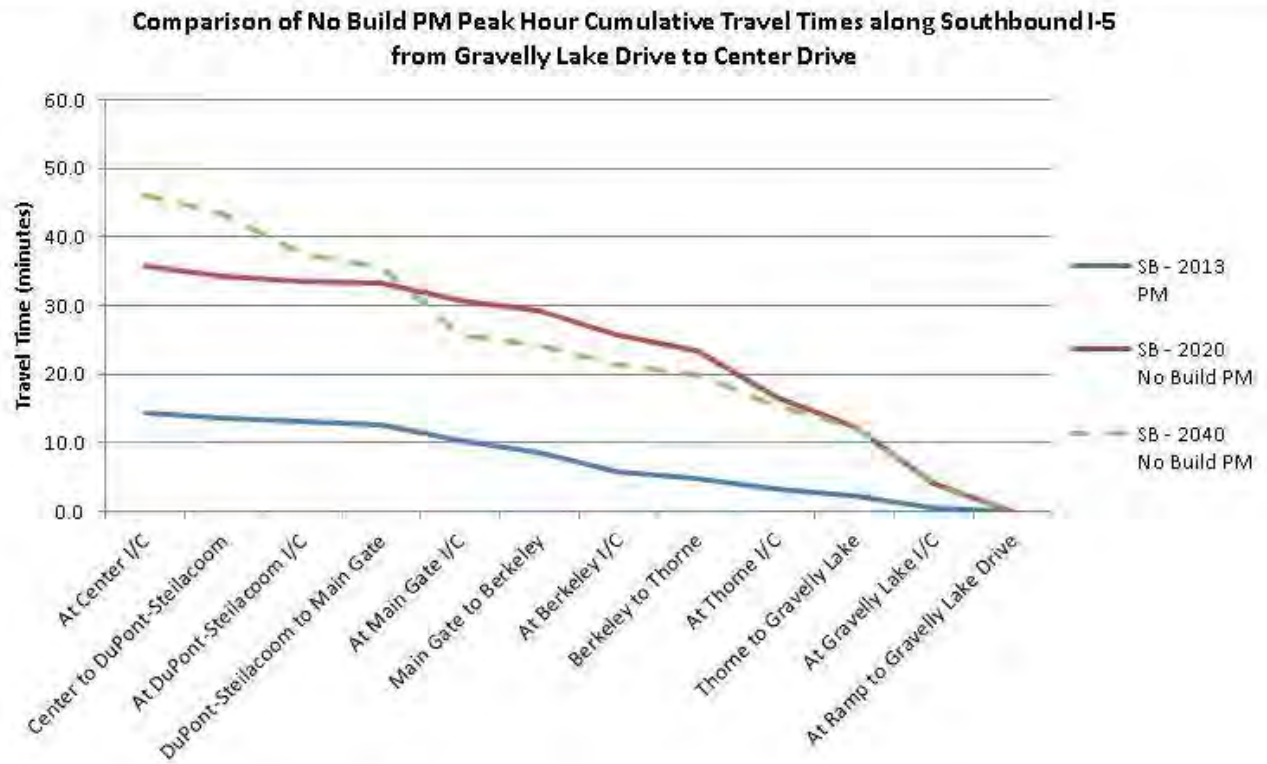
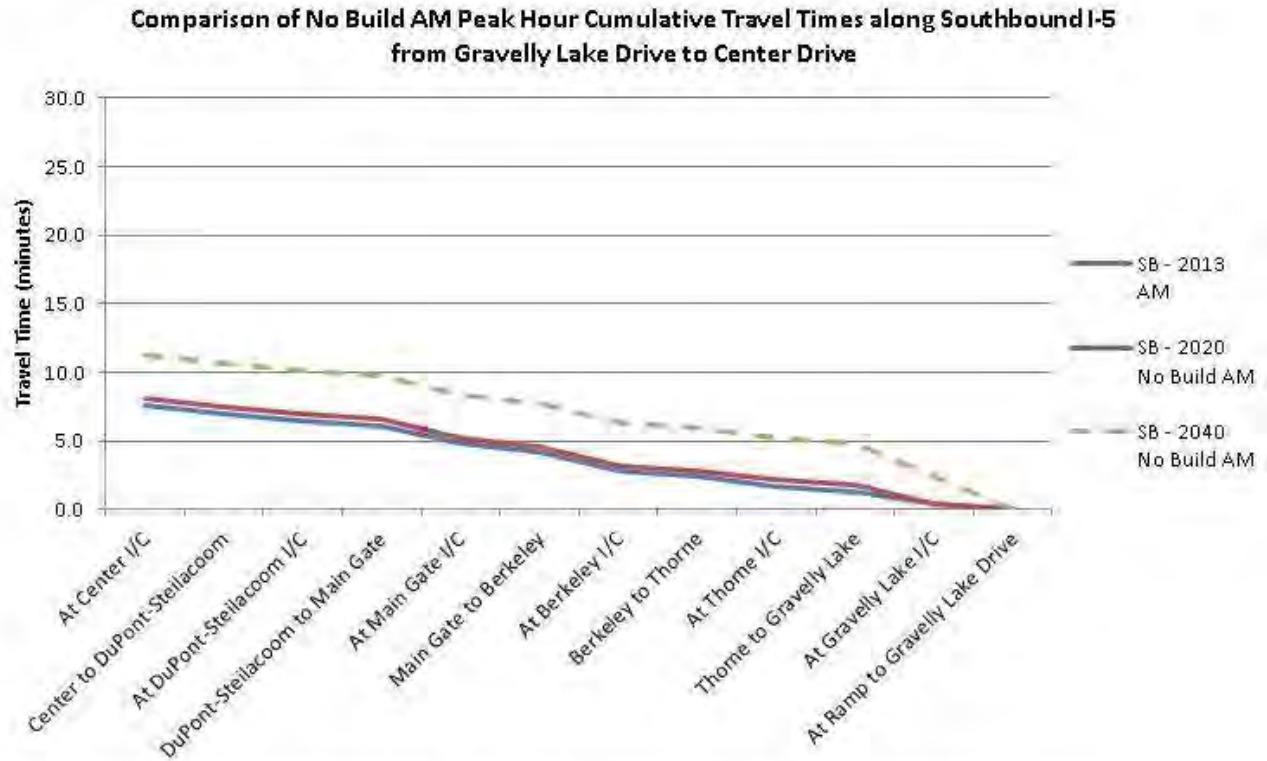
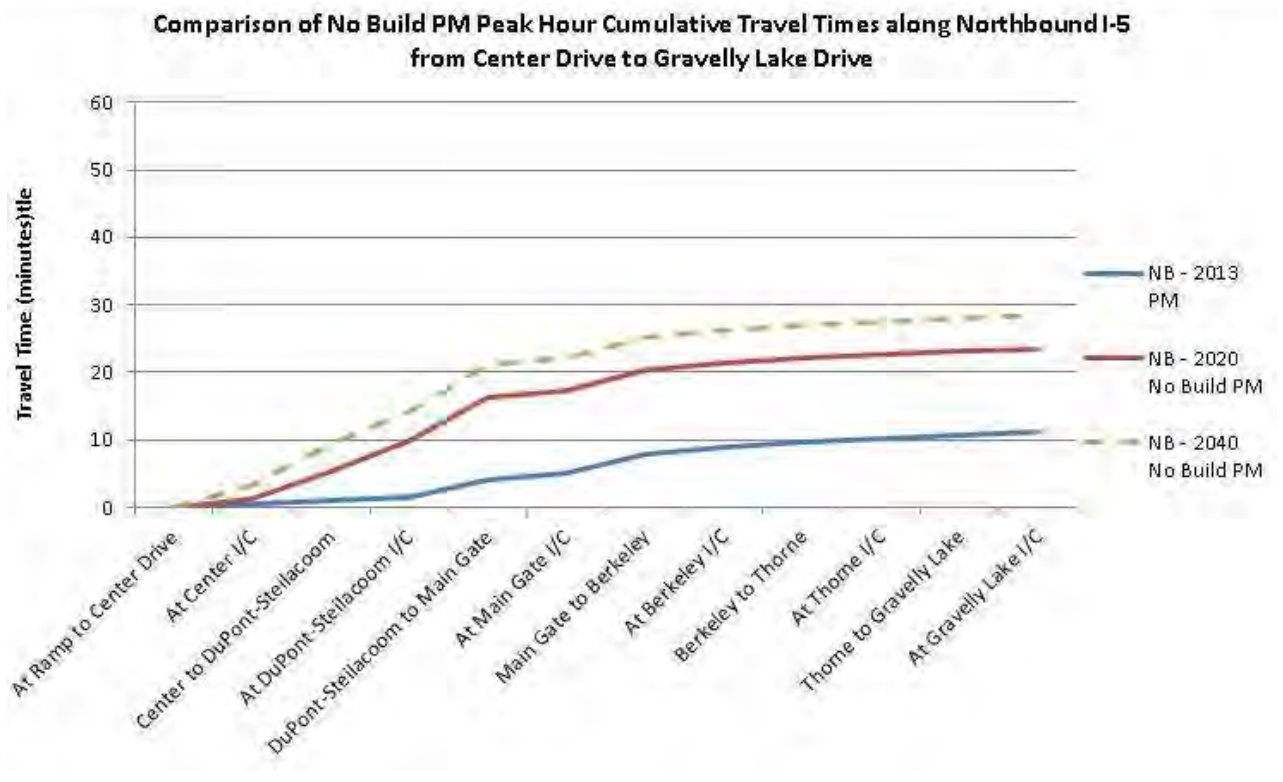
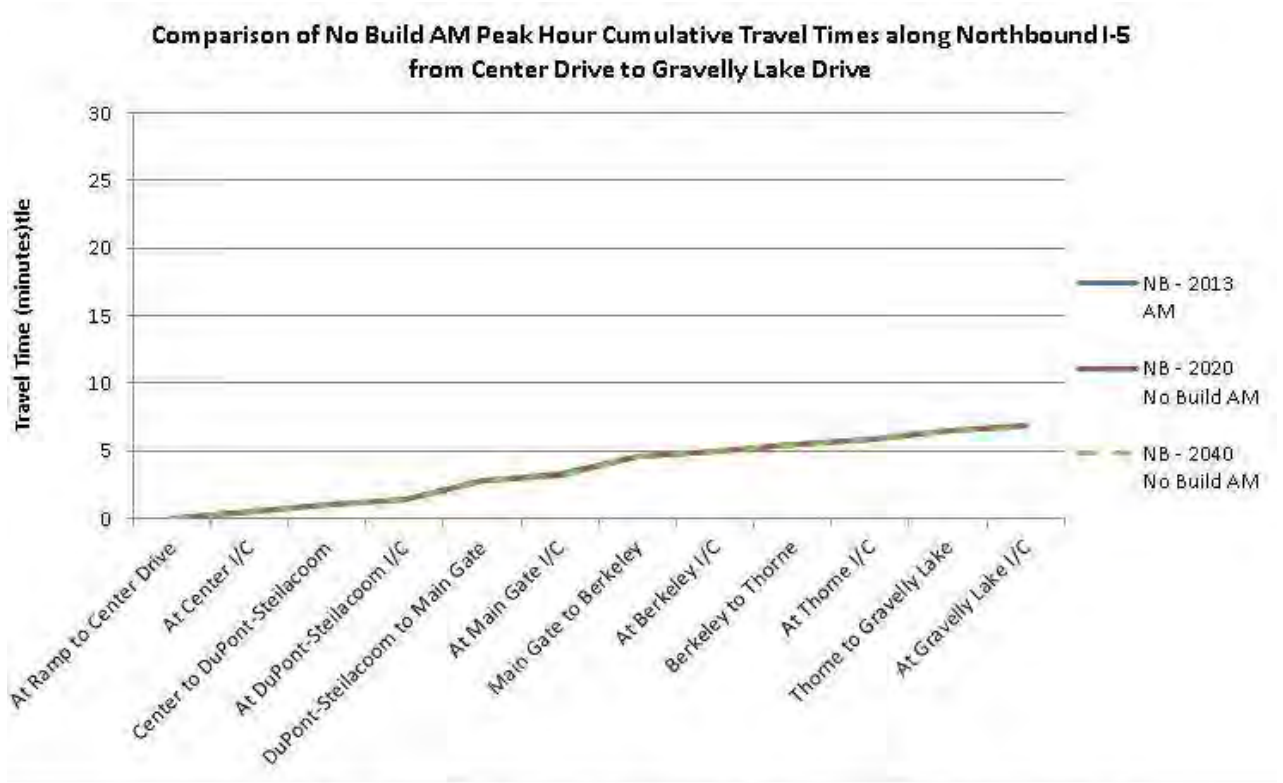

Figure 27: Comparison of Northbound Cumulative Travel Times during AM and PM Peak Hours – No Build Alternative



6.8 Summary of Future Year Intersection Analysis with the No Build Alternative at the Reconfigured and Adjacent Interchanges along I-5

The future year intersection analyses at the I-5 interchanges with the No Build Alternative assumed that the following intersection and mainline improvements were implemented:

- A southbound auxiliary lane was added between the Thorne Lane on-ramp to the Berkeley Street off-ramp
- Ramp meters were added to the on-ramps at all interchanges except the northbound Thorne Lane ramp
- The Madigan Access improvements at the Berkeley Street Interchange were implemented, including a second left-turn lane on the southbound off-ramp, a second lane on the Berkeley Street bridge easterly towards JBLM, and a third lane on Murray Road from the northbound off-ramps into JBLM.
- I-5 northbound ramp intersection with Center Drive was improved to better tie the exit from JBLM into the intersection.

The intersection analyses were conducted using Synchro software following the Highway Capacity Manual procedures. The results of these analyses for the two Build Alternative interchanges are summarized in Table 4. The analyses show that during the AM and PM peak hours, intersections at the Thorne Lane Interchange would operate at LOS D or better in both 2020 and 2040. The interim Madigan Access Improvements would allow the Berkeley Street Interchange to operate at LOS D or better in 2020 and 2040.

The results of the intersection analyses for the adjacent interchanges at Center Drive, Steilacoom-DuPont Road, and Gravelly Lake Drive are summarized in Table 5. The analyses show that the ramp intersections at Center Drive, Steilacoom-DuPont Road, and at Gravelly Lake Drive would operate at LOS D or better during the 2020 AM and PM peak hours. In 2040 the southbound ramp intersections at Center Drive and Steilacoom-DuPont Road would operate at LOS E during the AM peak hour. During the 2040 PM peak hour the intersections of the northbound and southbound ramps at Steilacoom-DuPont Road and at Gravelly Lake Drive are expected to be at or below LOS D.

In reviewing these results, it is important to remember the following data constraints:

- Congestion along I-5 limits the amount of traffic wanting to use I-5, as indicated in the previous section (only 30 percent of the demand that wants to use I-5 during the 2040 PM peak hour can actually use I-5). This reduces the amount of traffic at the various intersections.
- The Synchro analyses do not account for queue back-ups on the on-ramps from the ramp meters or queues from I-5 congestion into the intersection.

A list of the turning movements used for both the Synchro analyses and from the mesoscopic model is shown in Appendix B. A more detailed summary of the intersection analyses is contained in Appendix C.

Table 4: Summary of Interchange Delay and Level of Service (LOS) at the Reconfigured Interchanges – No Build Alternative

Intersection ²	2013 Existing		2020 No Build ³		2040 No Build ³	
	AM	PM	AM	PM	AM	PM
<u>I-5 NB Ramps / Berkeley Street³</u>						
Control Type	Signal		Signal		Signal	
Average Delay (sec) / LOS	25.7/C	29.7/C	16.3/B	20.8/C	11.4/B	14.5/B
<u>I-5 SB Ramps / Berkeley Street³</u>						
Control Type	Signal		Signal		Signal	
Average Delay (sec) / LOS	69.2/E	54.0/D	36.0/D	26.0/C	32.4/C	23.8/C
<u>Berkeley Street / Union Avenue</u>						
Control Type	All-way Stop		Signal		Signal	
Average Delay (sec) / LOS	10.6/B	12.1/B	11.0/B	12.0/B	10.0/B	12.7/B
<u>Berkeley Street / Washington Ave</u>						
Control Type	2-way Stop		2-way Stop		2-way Stop	
Average Delay (sec) / LOS	NA	NA	12.6/B	14.3/B	14.2/B	12.2/B
<u>I-5 NB Ramps / Thorne Lane</u>						
Control Type	Signal		Signal		Signal	
Average Delay (sec) / LOS	56.9/E	71.2/E	34.2/C	37.9/D	37.3/D	36.6/D
<u>I-5 SB Ramps / Thorne Lane</u>						
Control Type	Signal		Signal		Signal	
Average Delay (sec) / LOS	58.7/E	49.1/D	33.9/C	47.5/D	49.5/D	44.4/D
<u>Thorne Lane / Union Avenue</u>						
Control Type	2-way Stop		2-way Stop		2-way Stop	
Average Delay (sec) / LOS	9.6/A	11.1/B	10.4/B	11.6/B	11.2/B	12.8/B

Notes ¹ LOS values less than “D” shown in bold font

² Signalized & non-signalized intersections analyzed using Synchro software. Please note that the Synchro analysis does not account for back-ups on on-ramp from the ramp meter or freeway.

³ Assumes Madigan Access Improvements at the Berkeley Street Interchange are implemented by 2020

Table 5: Summary of Interchange Delay and Level of Service (LOS) at other Area Interchanges – No Build Alternative

Intersection ²	2013 Existing		2020 No Build		2040 No Build	
	AM	PM	AM	PM	AM	PM
<u>I-5 NB Ramps / Center Drive³</u>						
Control Type	2-way Stop		2-way Stop		2-way Stop	
Average Delay (sec) / LOS	NA	40.8/E	12.3/B	12.7/B	12.0/B	11.9/B
<u>I-5 SB Ramps / Center Drive</u>						
Control Type	2-way Stop		2-way Stop		2-way Stop	
Average Delay (sec) / LOS	13.9/B	12.7/B	18.6/C	13.3/B	35.1/E	13.2/B
<u>Center Drive / Wilmington Drive</u>						
Control Type	Signal		Signal		Signal	
Average Delay (sec) / LOS	13.0/B	14.7/B	14.1/B	20.2/C	18.4/B	20.2/C
<u>I-5 NB Ramps / Steilacoom-DuPont Road</u>						
Control Type	Signal		Signal		Signal	
Average Delay (sec) / LOS	32.3/C	49.9/D	22.5/C	45.1/D	29.7/C	57.9/E
<u>I-5 SB Ramps / Steilacoom-DuPont Road</u>						
Control Type	Signal		Signal		Signal	
Average Delay (sec) / LOS	18.8/B	27.3/C	34.0/C	29.1/C	68.7/E	37.5/D
<u>Steilacoom-DuPont Road / Barksdale Avenue / Wilmington Drive</u>						
Control Type	Signal		Signal		Signal	
Average Delay (sec) / LOS	43.1/D	29.7/C	36.9/D	27.1/C	58.2/E	26.6/C
<u>I-5 NB Ramps / Gravelly Lake Drive</u>						
Control Type	Signal		Signal		Signal	
Average Delay (sec) / LOS	39.8/D	70.3/E	46.5/D	41.6/D	35.4/D	49.6/D
<u>I-5 SB Ramps / Gravelly Lake Drive</u>						
Control Type	Signal		Signal		Signal	
Average Delay (sec) / LOS	41.9/D	47.3/D	31.3/C	37.2/D	32.8/C	40.8/D
<u>Gravelly Lake Drive / Pacific Highway</u>						
Control Type	Signal		Signal		Signal	
Average Delay (sec) / LOS	25.5/C	29.0/C	32.0/C	37.1/D	34.6/C	34.7/C

Notes ¹ LOS values less than “D” shown in bold font

² Signalized & non-signalized intersections analyzed using Synchro software. Please note that the Synchro analysis does not account for back-ups on on-ramp from the ramp meter or freeway.

³ The I-5 NB Ramps / Center Drive intersection was redesigned in 2015. This new design is reflected in the 2020 and 2040 analysis.

7.0 Description of the Build Alternative

Based on the analysis conducted in the *Corridor Plan Feasibility Study*, the *Multimodal Alternatives Analysis*, and the preliminary corridor traffic analysis, the most promising alternative was selected for further environmental analysis as part of the NEPA assessment and the I-5 JBLM Vicinity Interchange Justification Report (IJR). The *Corridor Plan Feasibility Study*, the *Multimodal Alternatives Analysis*, and a description of the alternative packages considered are included in Appendix E. The Build Alternative includes the following elements, as illustrated in Figure 28:

- **Mainline widening** adds a fourth lane northbound on I-5 from the Steilacoom-DuPont Road interchange on-ramp to Thorne Lane interchange, and southbound from Thorne Lane to Center Drive. The new lanes would operate for General Purpose (GP) traffic. See Figure 28 for an illustration of the added travel lanes.
- **Auxiliary lanes** would be added northbound between the Berkeley Street and Thorne Lane interchanges and between the Thorne Lane and Gravelly Lake Drive interchanges. The existing southbound auxiliary lanes would be maintained between Thorne Lane and Berkeley Street and between Center Drive and Mounts Road. The existing northbound auxiliary lane between Center Drive and Steilacoom-DuPont Road would also be maintained. See Figure 29 for the location of existing and proposed auxiliary lanes.
- **Interchange reconfigurations** are included at Thorne Lane and at Berkeley Street:
 - The Thorne Lane Interchange would be relocated approximately 350 feet south of the existing Thorne Lane Bridge and reconfigured as a tight diamond interchange with roundabouts at the ramp intersections. It would be elevated to grade separate Thorne Lane over the adjacent rail line and Union Avenue. A new loop road would be added to connect Thorne Lane with Union Avenue. A preliminary rendering of the relocated Thorne Lane Interchange is illustrated in Figure 30.
 - The Berkeley Street Interchange would be relocated approximately 120 feet south of the existing Berkeley Street Bridge and reconfigured as a tight diamond interchange with roundabouts at the ramp intersections. It would be elevated to grade separate the extension of Jackson Avenue over the adjacent rail line and Militia Drive. The extended Jackson Avenue would loop around an existing business and descend to grade at the intersection of Berkeley Street and Washington Avenue. A preliminary rendering of the relocated Berkeley Street Interchange is also illustrated in Figure 30.
 - The relocated interchanges would be designed to accommodate I-5 mainline widening, improve traffic operations at the interchanges, provide pedestrian and bicycle facilities and accommodate planned community growth and support activities at JBLM and Camp Murray through improved access and circulation.

Figure 28: Proposed Build Alternative

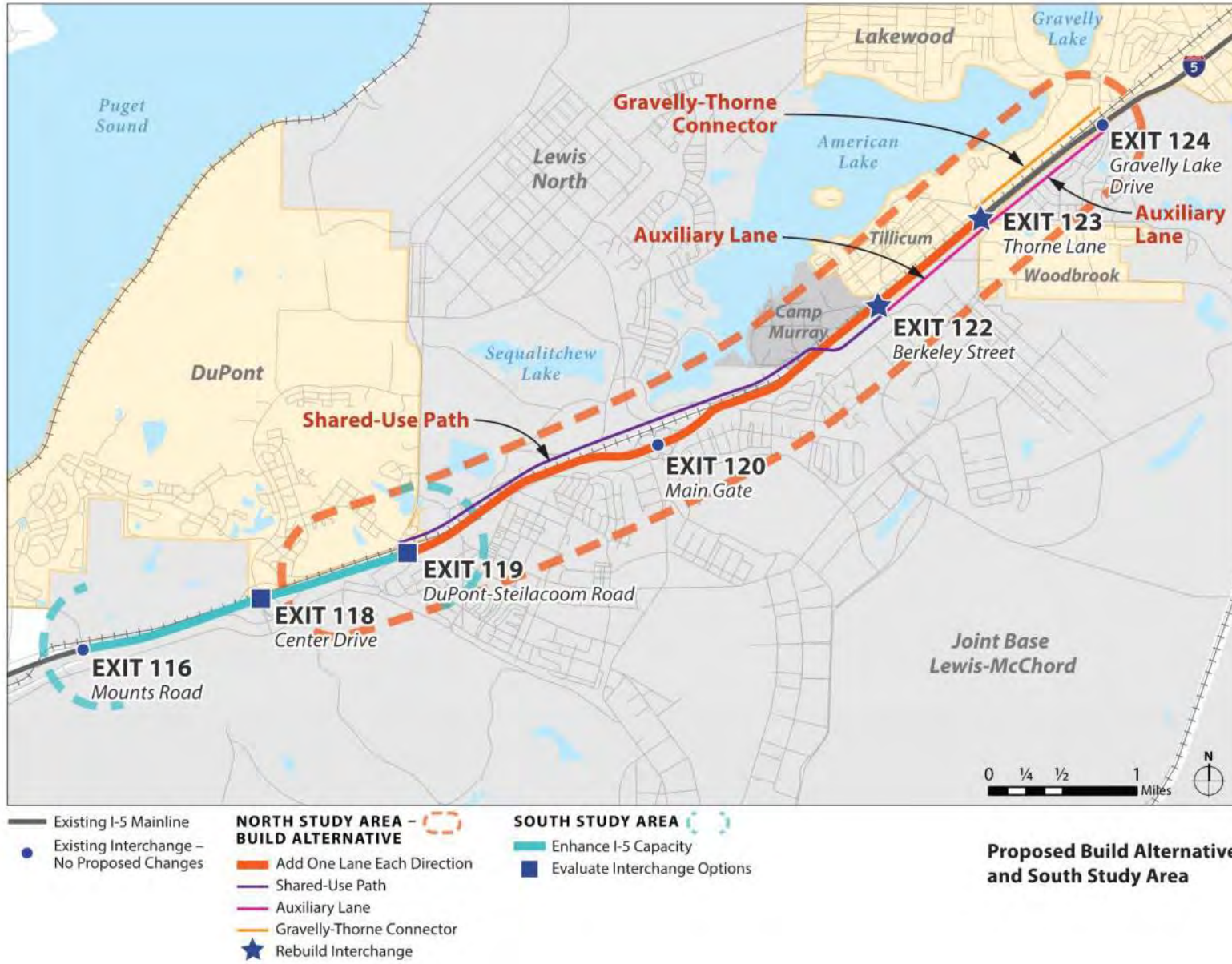

Proposed Build Alternative and South Study Area

Figure 29: Existing and Proposed I-5 Build Alternative with Average Daily Traffic

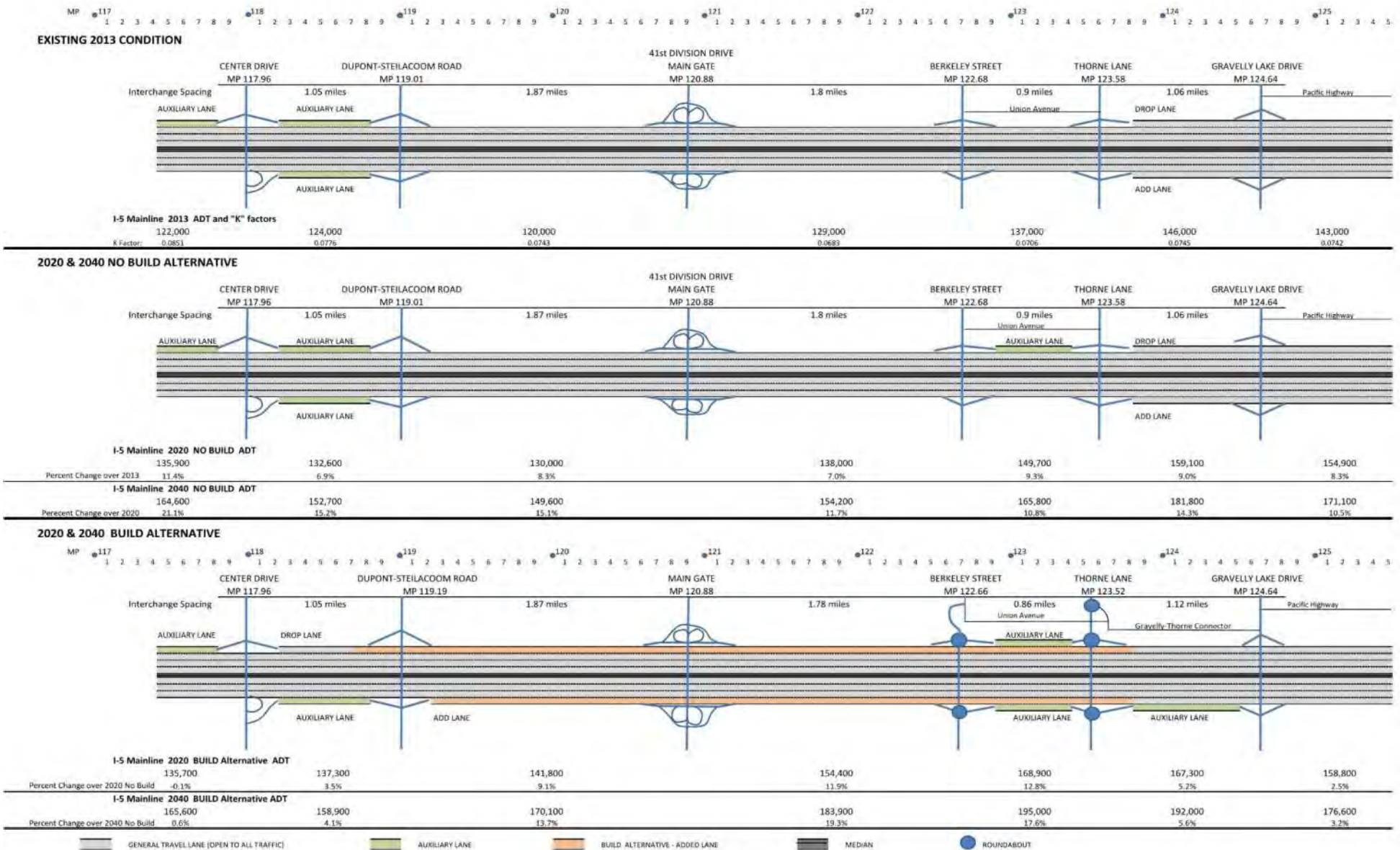

Figure 30: Proposed Thorne Lane and Berkeley Street Interchange Concepts



Rendering of the Proposed I-5/Thorne Lane Interchange



Rendering of the Proposed I-5/Berkeley Street Interchange

- Gravelly -Thorne Connector** would be constructed to reduce short trips on I-5 between the Tillicum neighborhood and Lakewood. The new connector road would be a single southbound lane parallel and west of the adjacent rail line and extend between Gravelly Lake Drive and Thorne Lane. A preliminary layout for the Gravelly-Thorne Connector is illustrated in Figure 31. The connector would use approximately 25 feet of the railroad right of way and approximately five feet of the golf course right of way. Non-motorized linkages would also be included in its design.

Figure 31: Proposed Gravelly-Thorne Connector



- Bicycle/pedestrian shared use path** would be added to provide enhanced non-motorized access along the corridor. A preliminary layout of the bicycle/pedestrian route is illustrated in Figure 32. New sections of the shared used paths are planned along the new Gravelly-Thorne Connector (segment one in the figure), as well as from the new Berkeley Street interchange along the east side of I-5 crossing to the west side just south of Camp Murray and extending to Steilacoom-DuPont Road (segment three). Between Thorne Lane and Berkeley Street (segment two), and between Center Drive and Steilacoom-DuPont Road (segment four), bicycles and pedestrians would use existing local streets and pedestrian facilities in the communities of Tillicum and DuPont.

Figure 32: Recommended Bicycle/Pedestrian Pathway Concept



8.0 2020 and 2040 I-5 Traffic Analysis for the Build Alternative

The following section summarizes the traffic operations along I-5 for the Build Alternative in the opening year (2020) and in the design year (2040). Synchro software was used to analyze signalized and non-signalized intersections; Sidra software was used to analyze roundabout operations; and SimTraffic and the Meso Model were used to simulate traffic operations.

8.1 2020 and 2040 Build Alternative Average Peak Hour I-5 Traffic Volumes

The forecasted travel volumes along I-5 for the Build Alternative during the AM and PM peak hours are shown in Figures 33 and 34, respectively. In 2020, the two-way traffic volume along I-5 between Center Drive and Gravelly Lake Drive would range from approximately 9,200 to nearly 10,900 vehicles in the AM peak hour with an overall average volume of about 10,200 vehicles. During the 2020 PM peak hour, two-way traffic volumes would range from 8,200 to nearly 11,300 vehicles with an overall average of about 9,900 vehicles. These AM peak hour Build Alternative volumes would represent a 6.6 percent increase in vehicles over the 2020 No Build Alternative, and the PM peak hour Build Alternative volumes would be about 12.5 percent higher than 2020 No Build Alternative volumes.

In 2040, the two-way traffic volume along I-5 would range from approximately 10,100 to nearly 13,300 vehicles in the AM peak hour with an overall average two-way volume of 11,700 vehicles. In the 2040 PM peak hour, two-way traffic volumes on I-5 are expected to range from about 7,700 to 11,100 vehicles with an average of about 9,400 vehicles operating along I-5. These AM peak hour Build Alternative volumes would represent an 18.8 percent increase in vehicles over the 2040 No Build Alternative, while PM peak hour Build Alternative volumes would be about 8.8 percent higher than the No Build Alternative.

The lower PM vehicle trips along I-5 in 2040, as compared to the AM vehicle trips are expected to result because the increases congestion would cause lower travel speeds in the PM peak. This would reduce the number of vehicles than can actually use the I-5 corridor during the PM peak hour. The small growth in vehicles along I-5 between 2020 and 2040 in the AM peak hour, and the decrease in vehicle trips in the PM peak hour would result from the reduction in average travel speeds along I-5, caused by increased congestion, and by trips being diverted to other travel times to avoid congestion.

Figure 33: Average 2020 and 2040 AM Peak Hour Volumes on I-5 from Center Drive to Gravelly Lake Drive – Build Alternative

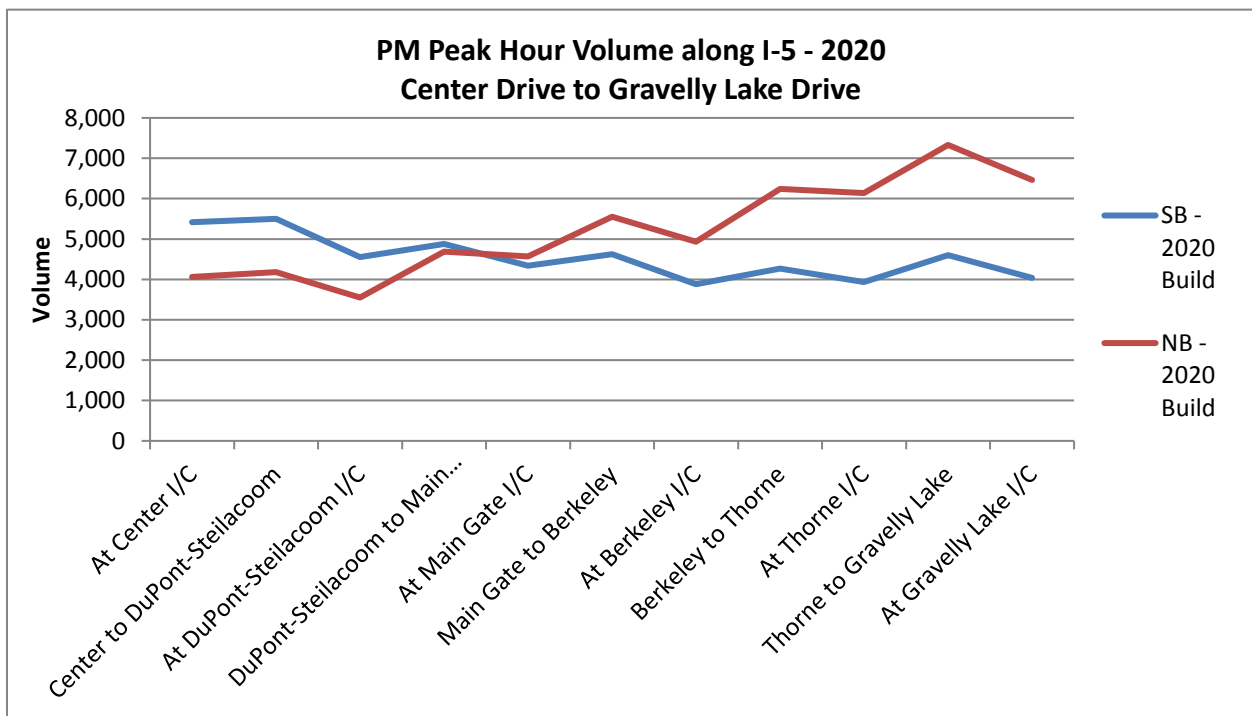
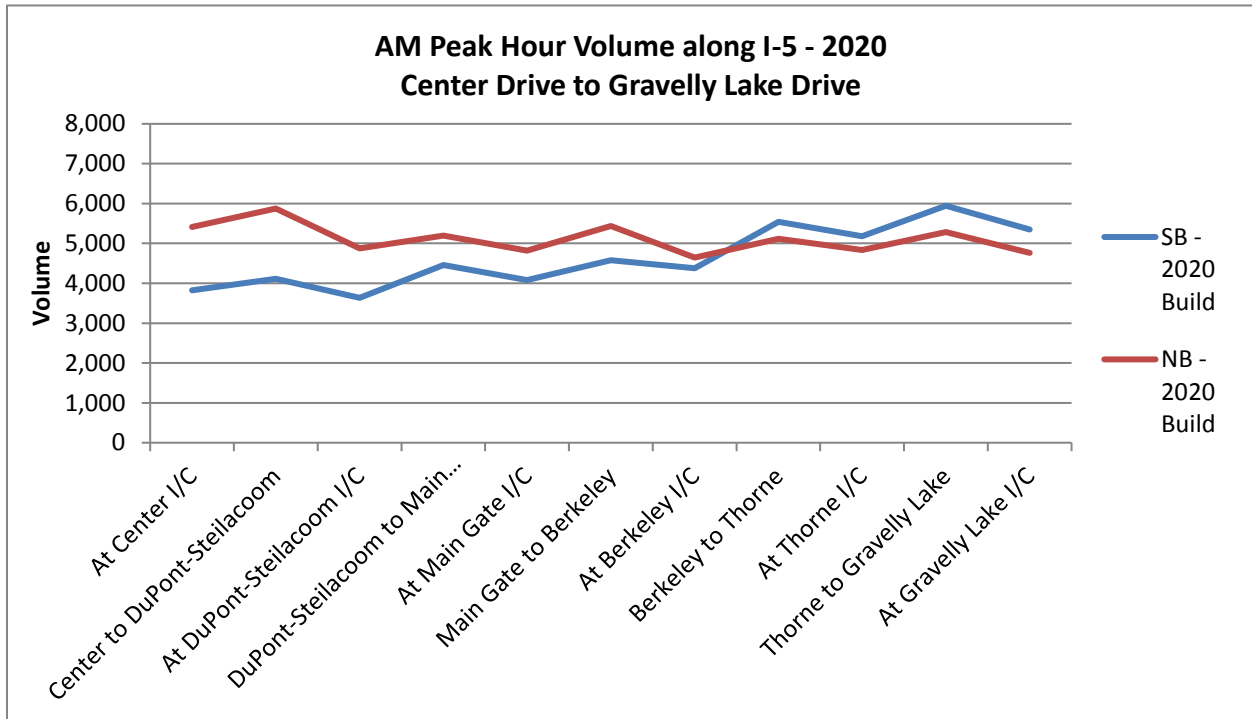
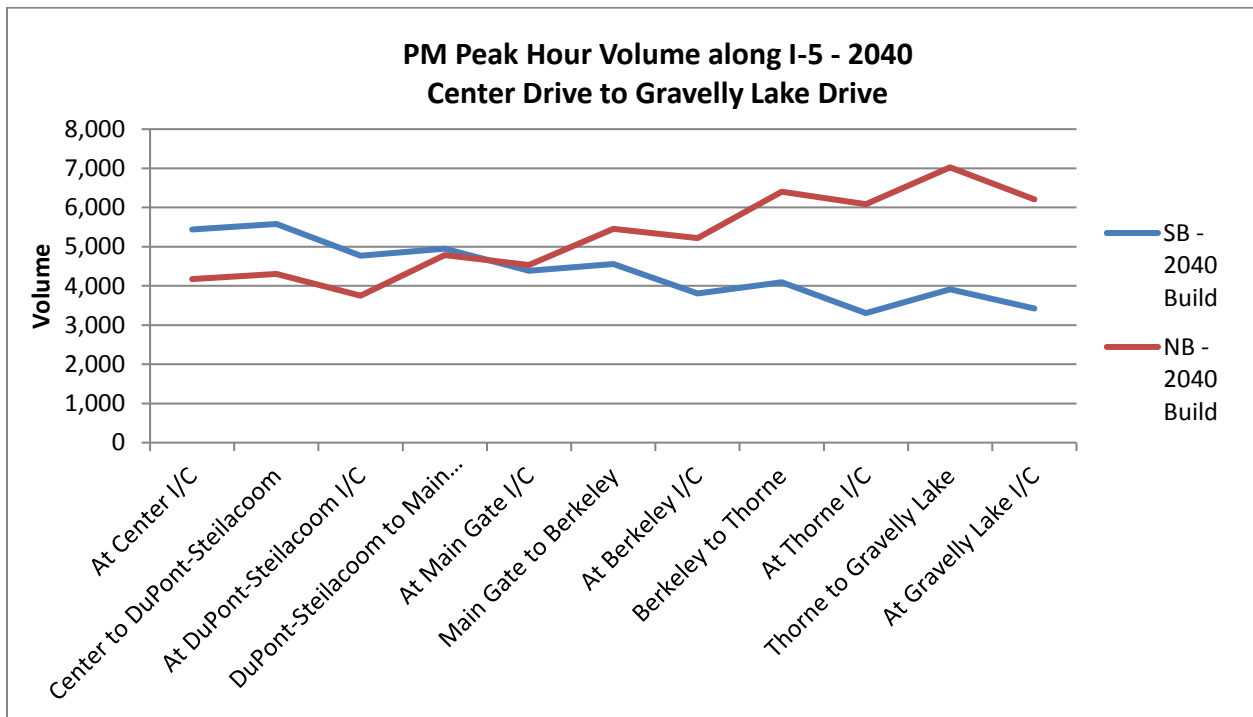
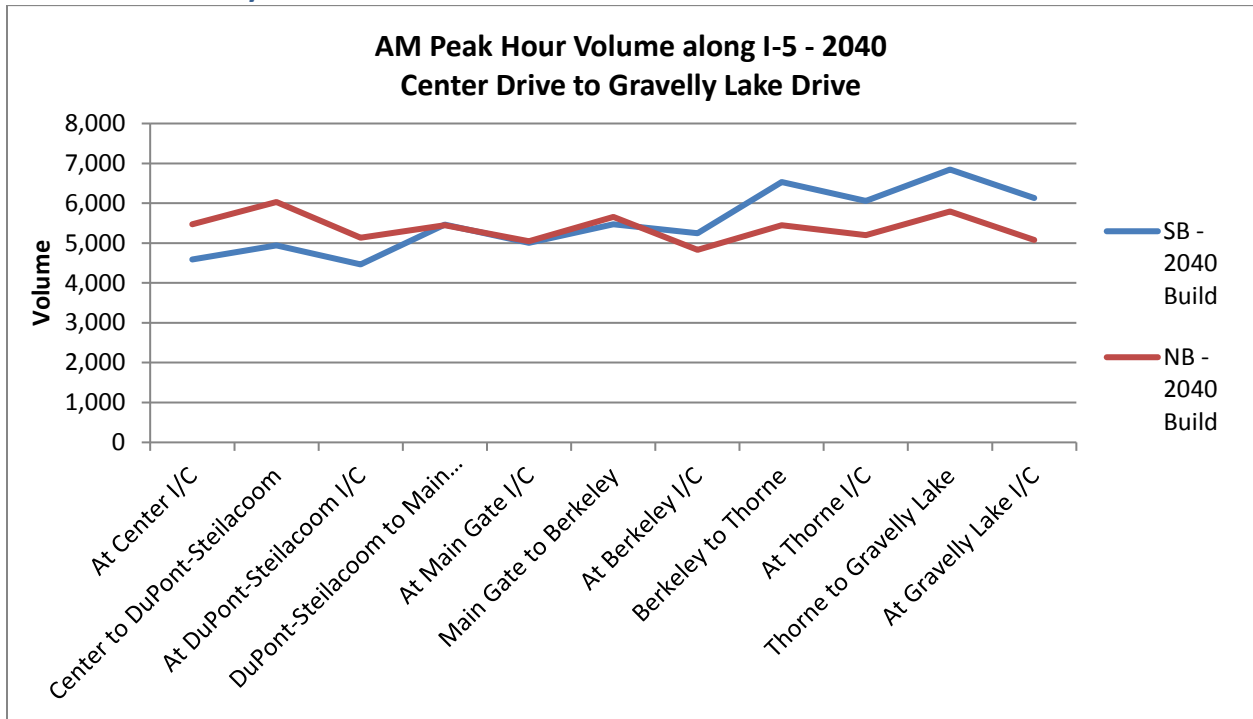

Figure 34: Average 2020 & 2040 PM Peak Hour Vehicles along I-5 from Center Drive Road to Gravelly Lake Drive – Build Alternative



8.2 Travel Demand along I-5 – Build Alternative

PM Peak Hour – As shown in Figure 35, the level of demand for travel on I-5 during the PM peak hour is substantively higher than what could actually be accommodated with either the No Build or Build Alternatives. Additionally, the No Build Alternative could accommodate less travel demand on I-5 than the Build Alternative.

In 2020, the Build Alternative could accommodate a slightly higher percentage of the demand than the 2013 existing system (89.2 percent vs. 88.1 percent), and almost 19 percent more (89.2 percent vs. 70.5 percent) than the 2020 No Build Alternative. By 2040, the Build Alternative could accommodate about 49 percent of the PM peak hour demand, while the No Build Alternative could accommodate only about 30 percent of the demand. This finding is a useful indicator of the duration of congestion which would not only affect the PM peak hour, but would likely spread into the hours adjacent to the peak. The greater the percentage of travel demand that cannot be met in a single peak hour, the greater the total number of hours of peak period congestion that would be expected.

During the AM peak hour in 2020, it is expected that nearly 99 percent of the demand for travel on I-5 could be accommodated with the Build Alternative. This compares with the 2020 No

Figure 35: 2020 & 2040 Travel Demand along I-5 during AM and PM Peak Hours from Center Drive to Gravelly Lake Drive – Build Alternative

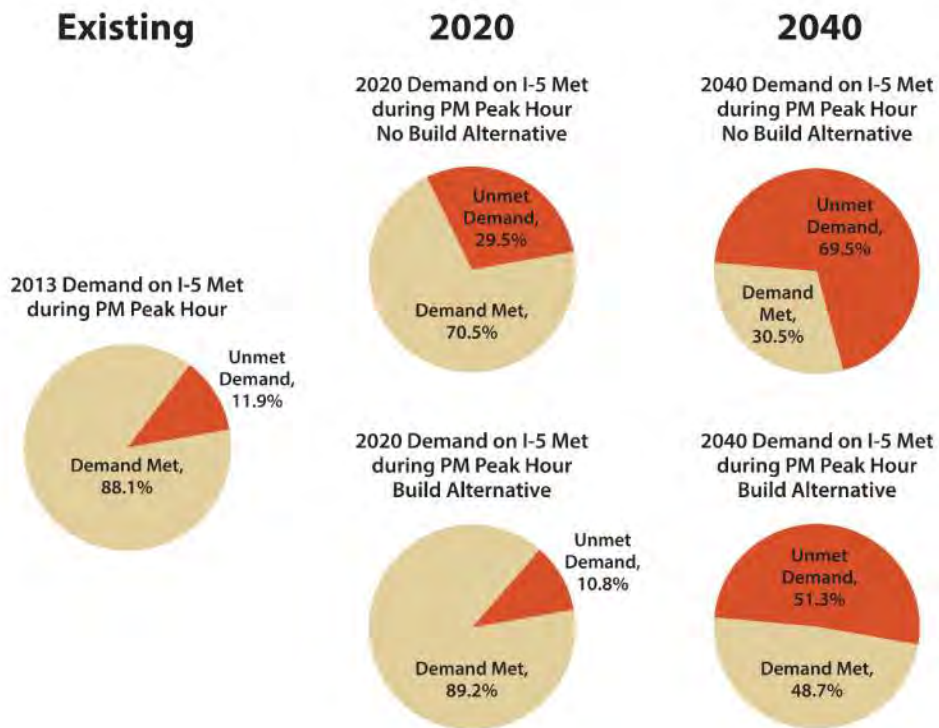

*Demand based on person miles of travel estimate from Mesoscopic

Build Alternative that could accommodate about seven percent less demand. In 2040, about 90 percent of AM peak hour travel demand on I-5 could be accommodated with the Build Alternative, as compared to the 2040 No Build Alternative which could accommodate about 29 percent less demand. Thus, while congestion would exist, the situation is expected to be substantially better than with the No Build Alternative.

PM Peak Three Hours: While over 88 percent of existing demand during the single 2013 PM peak hour can be accommodated in the corridor, Figure 36 shows that nearly everyone who wanted to travel on I-5 in 2013 could make the journey at some point during the three hour PM peak period. Only one percent of all PM peak three hour demand could not be satisfied during this time period. Figure 36 also shows that as demand grows to 2020, over 90 percent of demand could be accommodated with the No Build Alternative, while nearly 98 percent could be accommodated by the Build Alternative. By 2040, less than 72 percent of demand could be accommodated by the No Build Alternative, while the Build Alternative is expected to accommodate 80 percent of demand during the three-hour PM peak period.

Figure 36: Comparison of 3-Hour PM Peak Period Demand Met on I-5 in the Vicinity of JBLM

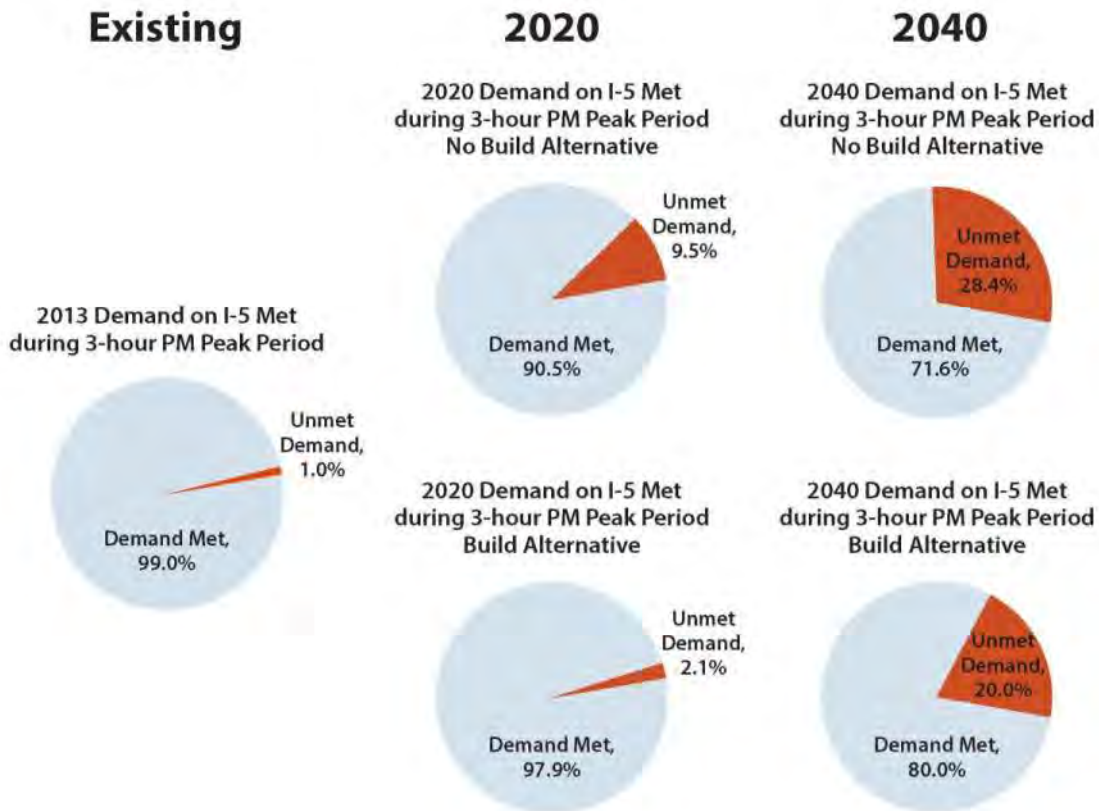

*Demand based on person miles of travel estimate from Mesoscopic travel

8.3 Future Build Alternative Average Peak Hour I-5 Travel Speeds

Expected average travel speeds along the I-5 corridor in 2020 and 2040 for the AM peak hour and the PM peak hour are illustrated in Figures 37 and 38, respectively. As can be observed from the figures, in both 2020 and 2040 travel speeds along I-5 in the AM peak hour with the proposed improvements range from 50 mph to 60 mph for most of the study area with southbound speeds falling below 50 mph north of Thorne Lane in 2040. These slower speeds are attributed to the increase in traffic volumes through this area. The southbound AM peak hour Build alternative speeds are estimated to increase by nearly ten percent in 2020 and over 40 percent in 2040 as compared to the No Build Alternative. In the northbound direction the AM peak hour speeds increase by about 12 percent in both 2020 and 2040 as compared to the No Build Alternative speeds.

During the PM peak hour with the proposed improvements in 2020, northbound travel speeds along I-5 fall below 42 mph or LOS F (the shaded areas show speeds less than 42 mph) north of the Berkeley Street Interchange as traffic volumes approach the practical capacity of the highway and drivers are changing lanes to enter and exit I-5. In the southbound direction in 2020, travel speeds along I-5 fall below 42 mph south of the Main Gate Interchange with speeds dropping to less than 10 mph, indicating area of stop-and-go traffic.

These slow speeds are caused by several factors, including the reduction of the number of southbound through travel lanes from four lanes to three lanes at Center Drive, the increase in traffic volumes, and drivers frequently change lanes to enter and exit I-5. However, these northbound speeds with the Build Alternative show a speed increase of more than 125 percent (44.2 mph vs. 19.4 mph) as compared to the No Build Alternative in 2020. While the southbound Build Alternative average speeds are about the same as the No Build Alternative at 13 mph due primarily to the reduction in the number of through lanes.

During the PM peak hour with the proposed improvements in 2040, southbound PM peak hour travel speeds are generally less than 10 mph from Gravelly Lake Drive to Center Drive. These slow speeds reduce the number of vehicles that can travel through the corridor during the PM peak hour and prevent other cars from entering the corridor.

Figure 37: 2020 & 2040 AM Peak Hour Travel Speed along I-5 from Center Drive to Gravelly Lake Drive – Build Alternative

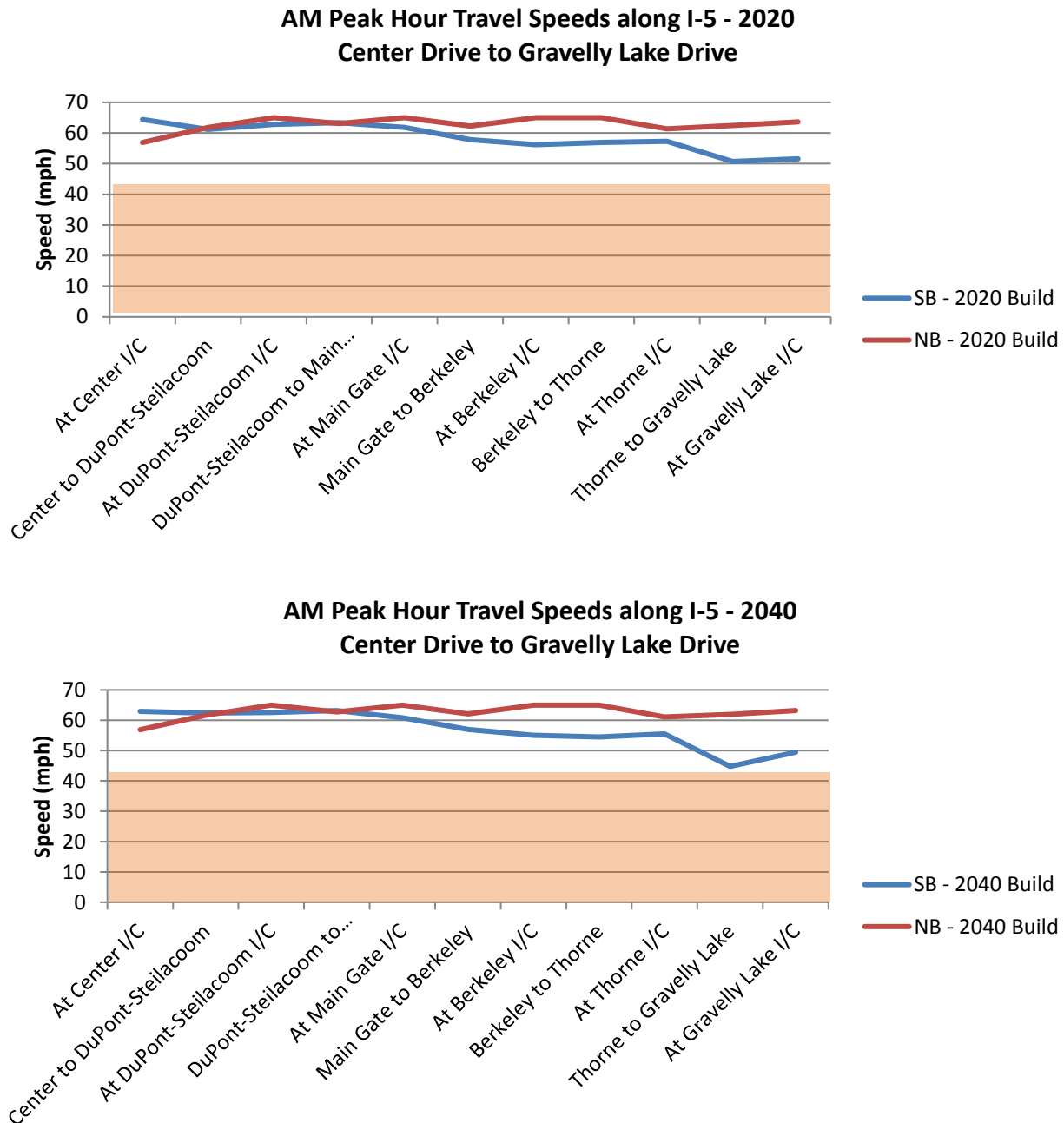

Based on the Meso Model data, estimates were made of the number of hours the travel speed operated below 70 percent of posted speed of 42 mph in 2020 and 2040. The analysis also showed that no hours of congestion are expected to occur during the AM peak period in 2020 and 2040, which correlates with the AM peak hour average travel speeds shown in Figure 36 above.

Figure 38: 2020 & 2040 PM Peak Hour Travel Speed along I-5 from Center Drive to Gravelly Lake Drive – Build Alternative

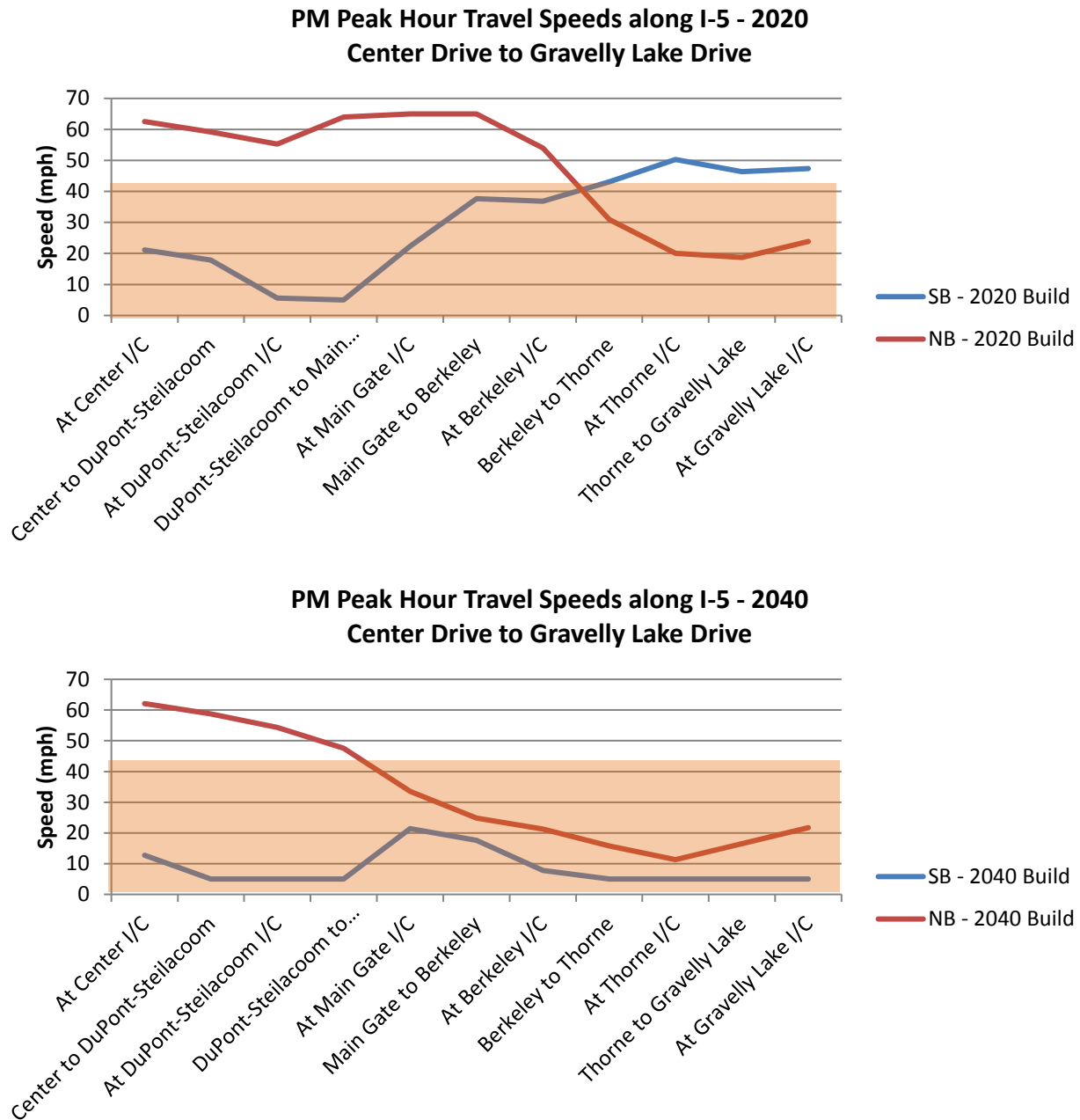

During 2040 northbound PM peak hour, travel speeds on I-5 between Center Drive and Steilacoom-DuPont Road are generally above 50 mph because of the added travel lane at Center Drive. North of Steilacoom-DuPont Road, as traffic volumes increase and drivers frequently change lane to enter and exit I-5, travel speed fall below 42 mph. These slow average PM speeds signify severe congestion with slow moving vehicles and periods of stop-and-go traffic. In 2040, the southbound Build Alternative average travel speeds are less the No

Build Alternative speeds (7 mph vs 10 mph); while the northbound Build Alternative average speeds increase by about 85 percent (27.3 mph for the Build alternative vs 14.8 mph for the No Build Alternative.) Southbound travel for the No Build Alternatives operates better south of Thorne Lane because the bottleneck occurs at the north end of the study area rather than at the south end, effectively metering the number of southbound vehicles using I-5 with the No Build Alternative. Figure 39 presents a summary map that illustrates and compares projected 2020 and 2040 travel speeds with the Build Alternative.

8.4 Peak Period I-5 Hours of Congestion – Build Alternative

During the PM peak period in 2020 and 2040, several hours of congestion are expected to occur along I-5 between Center Drive and Gravelly Lake Drive, as illustrated in Figure 40. During the 2020 PM peak period from two to four hours of congestion is expected northbound and southbound. During the 2040 PM peak period, congestion is expected to occur along the entire corridor in both directions that may last for nearly six hours.

These slow average speeds and hours of congestion expected during the PM peak period (2:00 PM and 8:00 PM) are also illustrated on the Congestion Contours shown in Figure 41. In 2020, southbound congestion would generally extend from north of the Main Gate Interchange to Center Drive. This congestion would be caused by the reduction in travel lanes from four lanes to three lanes at Center Drive and the high on-ramp volume at Center Drive. In the northbound direction in 2020, congestion would extend from around Berkeley Street to Bridgeport Way. In comparing these diagrams with the 2020 No Build Alternative diagrams, the duration and area of congestion is reduced.

By 2040, congestion is expected to extend past the 8:00 PM analysis period and would also extend north and south of the study area. In the southbound direction, congestion is expected to extend from Mounts Road past SR 512 for both the No Build and Build Alternatives. However, with the Build Alternative, there would generally be less congestion north of Berkeley Street. In the northbound direction during the 2040 PM peak period, congestion is expected to extend from north of Mounts Road with about one hour of congestion to nearly six hours of congestion at Bridgeport Way. South of Center Drive longer periods of congestion are expected.

Figure 39: 2020 and 2040 PM Peak Hour Travel Speeds on I-5 between Center Drive and Gravelly Lake Drive – Build Alternative

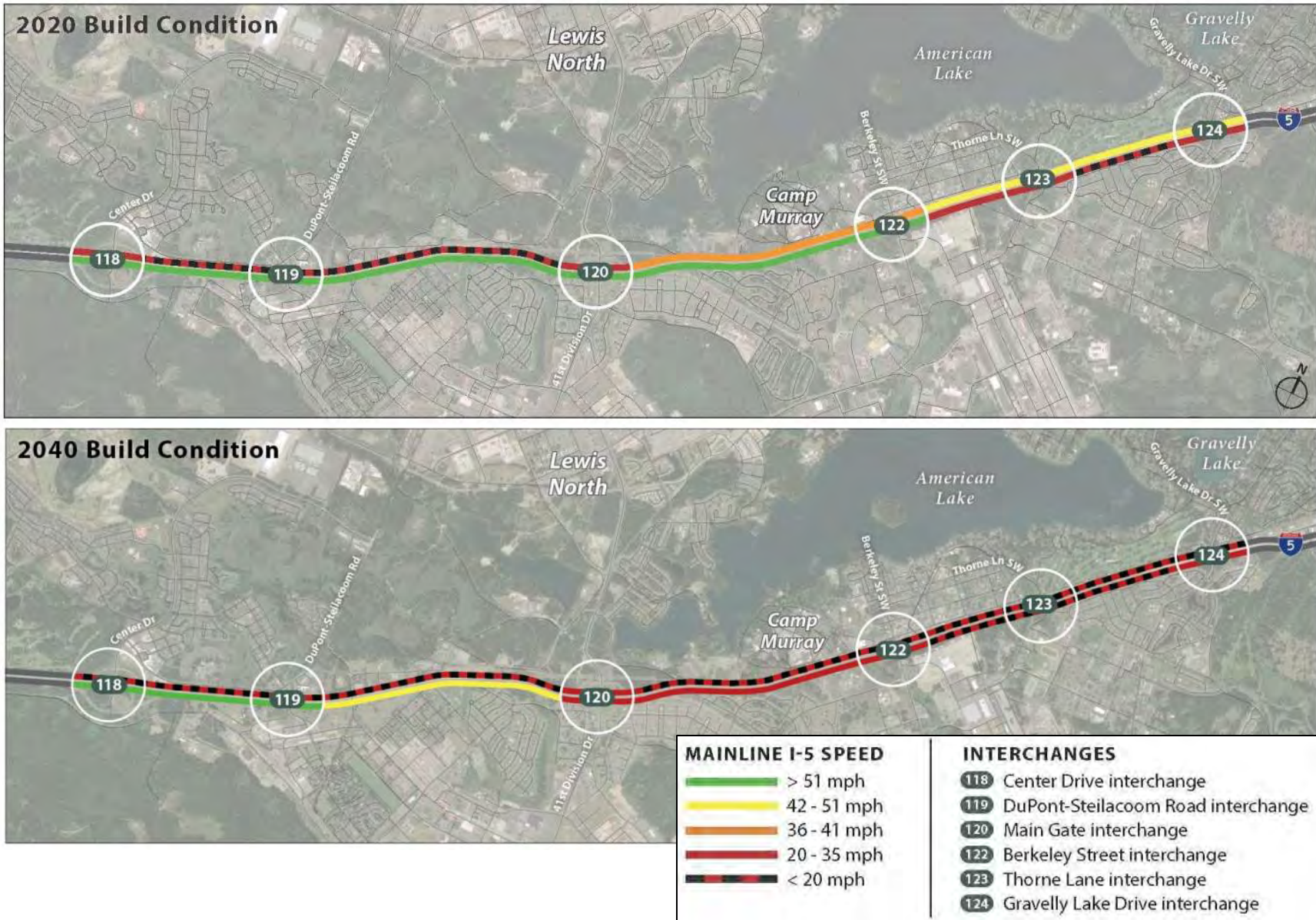

Figure 40: Hours of Congestion along I-5 during 2020 & 2040 PM Peak Period from Center Drive to Gravelly Lake Drive – Build Alternative

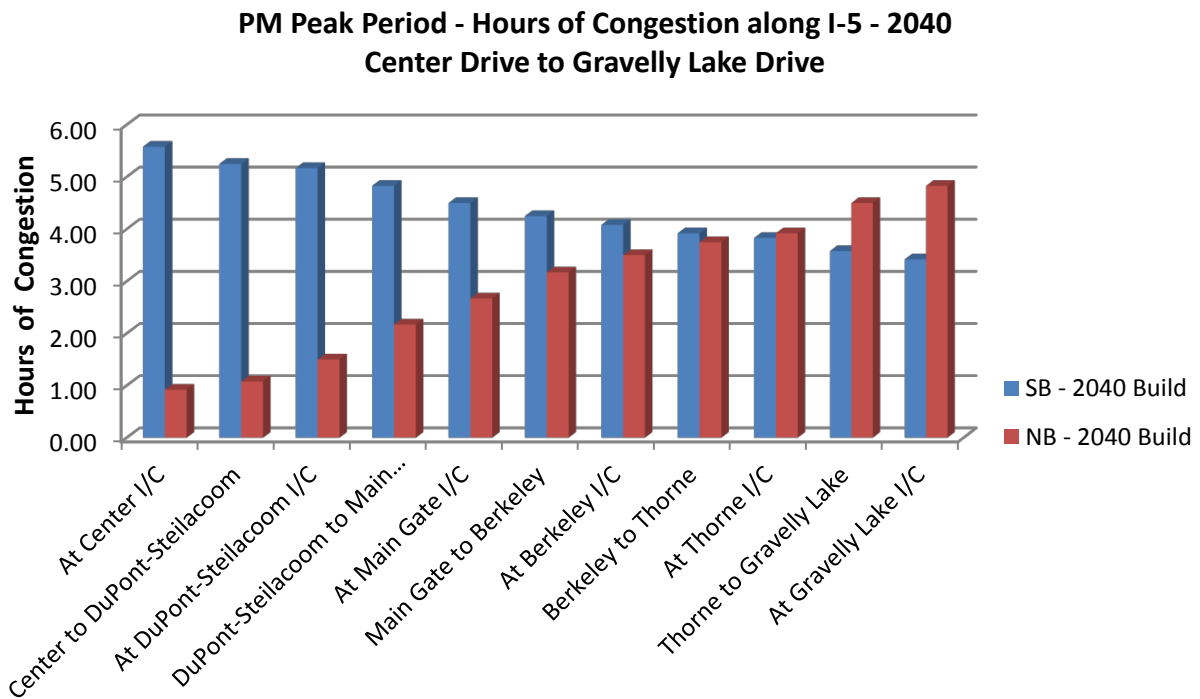
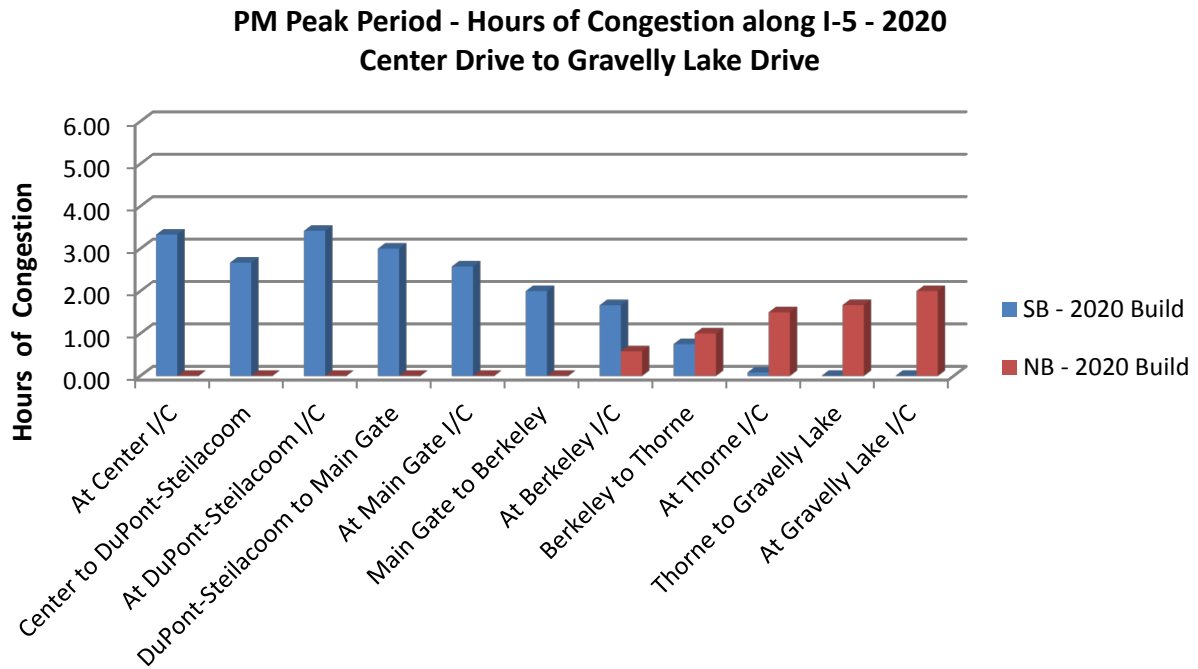
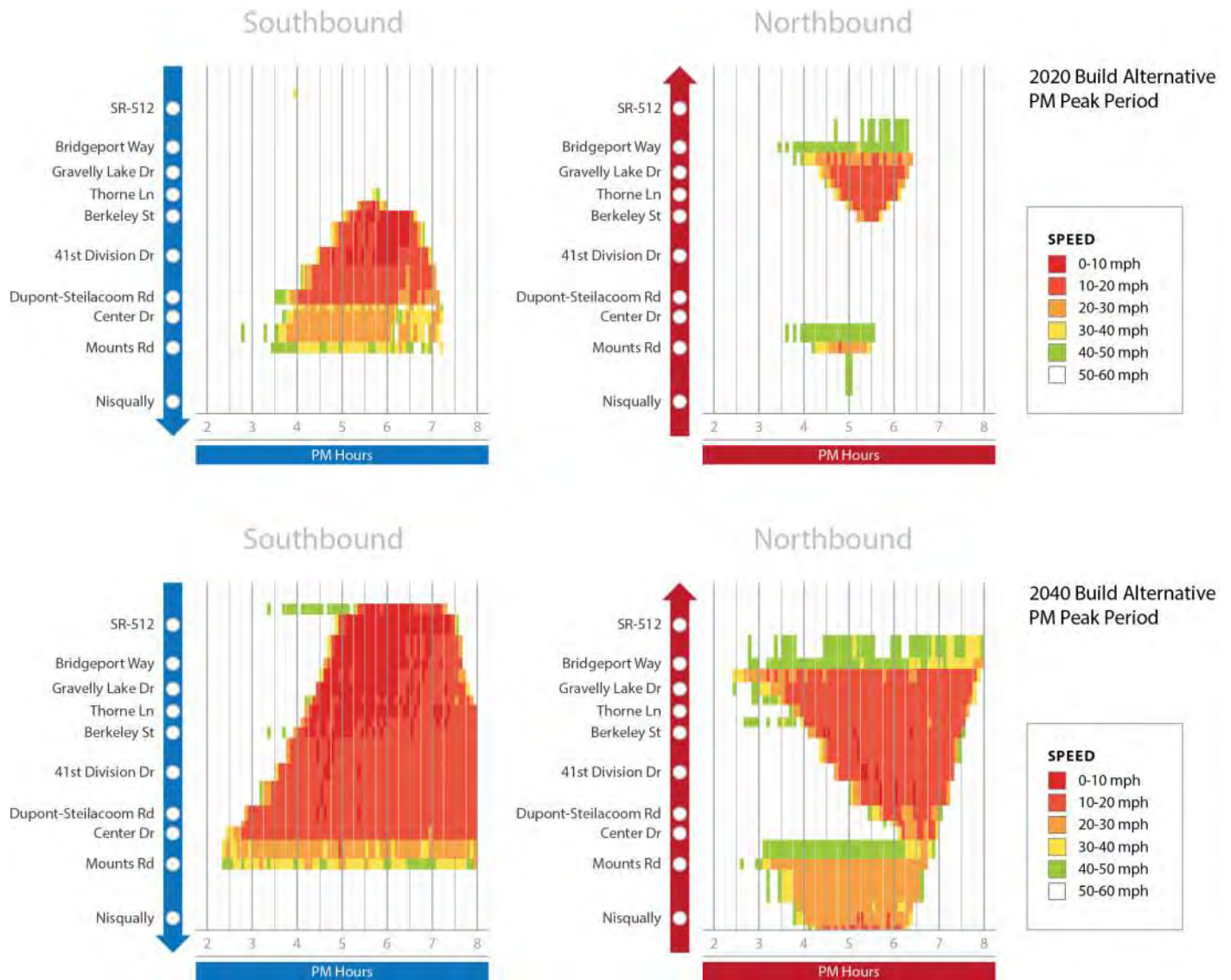

Figure 41: Travel Speeds along I-5 during the 2020 & 2040 PM Peak Period – Build Alternative



8.5 Peak Hour I-5 On and Off-Ramp Volumes – Build Alternative

On- and off-ramp volumes along I-5 between Center Drive and Gravelly Lake Drive would remain high in 2020 and 2040 peak hours for the Build Alternative. A comparison of the projected 2020 and 2040 AM peak hour on- and off-ramp volumes is shown in Figure 42. At these six interchanges there would be a total of about 3,840 vehicles exiting I-5 and 2,360 vehicles entering I-5 southbound in 2020, and about 3,660 vehicles exiting I-5 and 2,780 vehicles entering I-5 northbound in 2020 AM peak hour. The total of trips entering and exiting I-5 is more than the capacity of a single lane, and would require drivers to shift lanes.

Similarly, in 2040, there would be about 4,170 vehicles exiting I-5 and 2,750 vehicles entering I-5 at these six interchanges southbound, and about 3,900 vehicles exiting I-5 and 3,160 vehicles entering I-5 northbound. The total of trips entering and exiting I-5 would continue to be more than the capacity of a single lane, requiring drivers to shift lanes.

Figure 42: 2020 & 2040 AM On- and Off-Ramp Volume along I-5 from Center Drive to Gravelly Lake Drive – Build Alternative

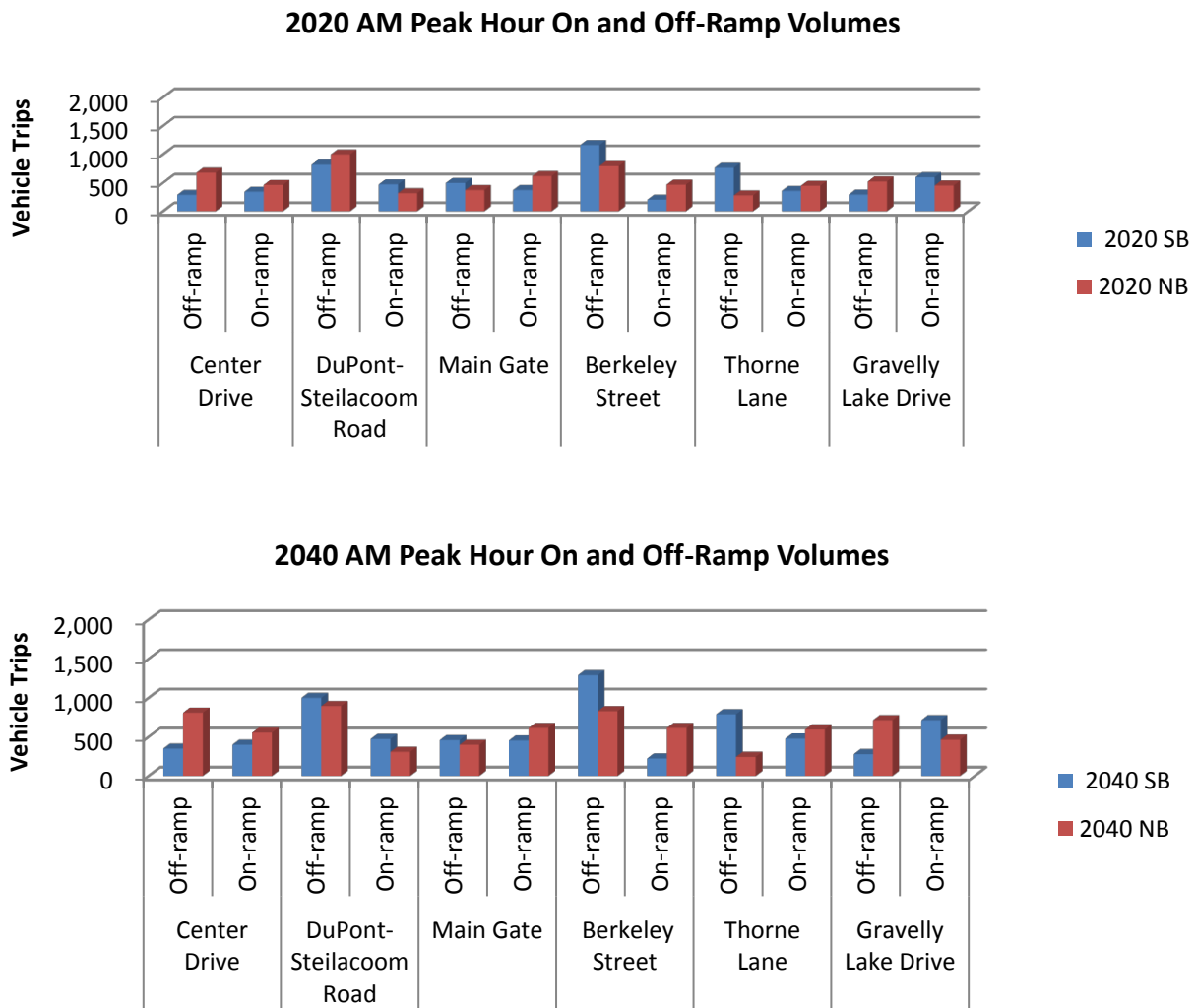

A comparison of the PM peak hour on- and off-ramp volumes in 2020 and 2040 is shown in Figure 43. Overall, at the interchanges along I-5 in the study area in 2020, there would be a total of about 2,210 vehicles exiting I-5 and 4,150 vehicles entering I-5 southbound, and about 2,800 vehicles exiting I-5 and 5,160 vehicles entering I-5 northbound.

Similarly, in 2040, there would be about 1,590 vehicles exiting I-5 and 4,430 vehicles entering I-5 at these interchanges southbound, and about 2,600 vehicles exiting I-5 and 4,820 vehicles entering I-5 at the study area interchanges northbound.

As with the existing conditions and the No Build Alternative, all of this traffic cannot be in the outside lane at the same time, so drivers must frequently change lanes to enter and exit I-5. This heavy amount of lane change movement would cause traffic to slow, increase congestion, and reduce the overall traffic throughput in the JBLM area.

Figure 43: 2020 & 2040 PM On- and Off-Ramp Volume along I-5 from Center Drive to Gravelly Lake Drive – Build Alternative

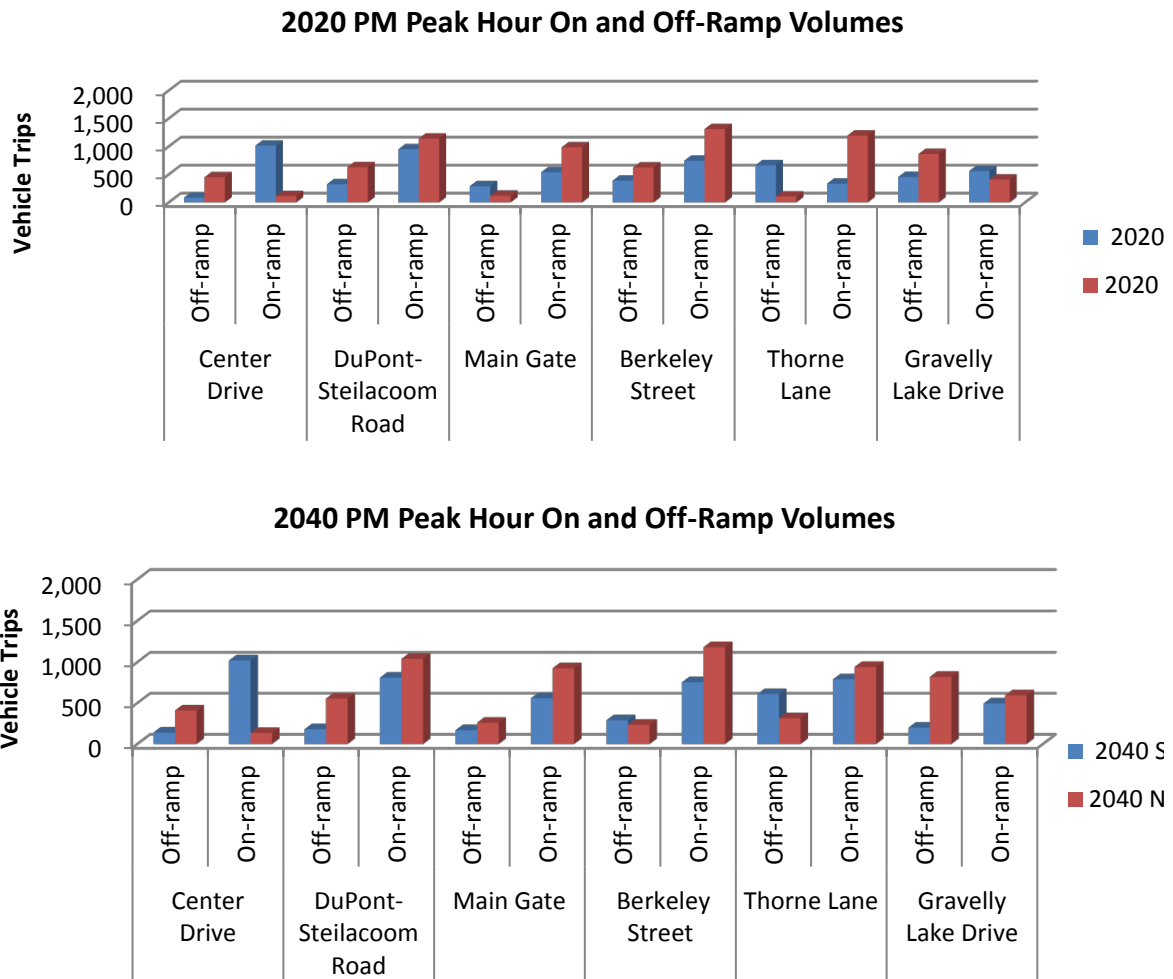

As compared to the 2020 and 2040 No Build Alternative on- and off-ramp volumes, these 2020 and 2040 Build Alternative ramp volumes would generally be within plus or minus 10 percent.

8.6 Comparison of I-5 Travel Times – No Build Alternative vs Build Alternative

A comparison of No Build Alternative travel times along I-5 between Center Drive and Gravelly Lake Drive was made using output from the Meso Model and is shown in Figure 44 for the AM and PM peak hours. Traveling along I-5 between Center Drive and Gravelly Lake Drive at the

posted speed limit would normally take about 8.2 minutes to cover the 8.2 miles between the two interchanges.

Figure 44: 2020 Cumulative PM Peak Hour Travel Times along I-5 between Center Drive and Gravelly Lake Drive –2020 No Build Alternative and Build Alternative

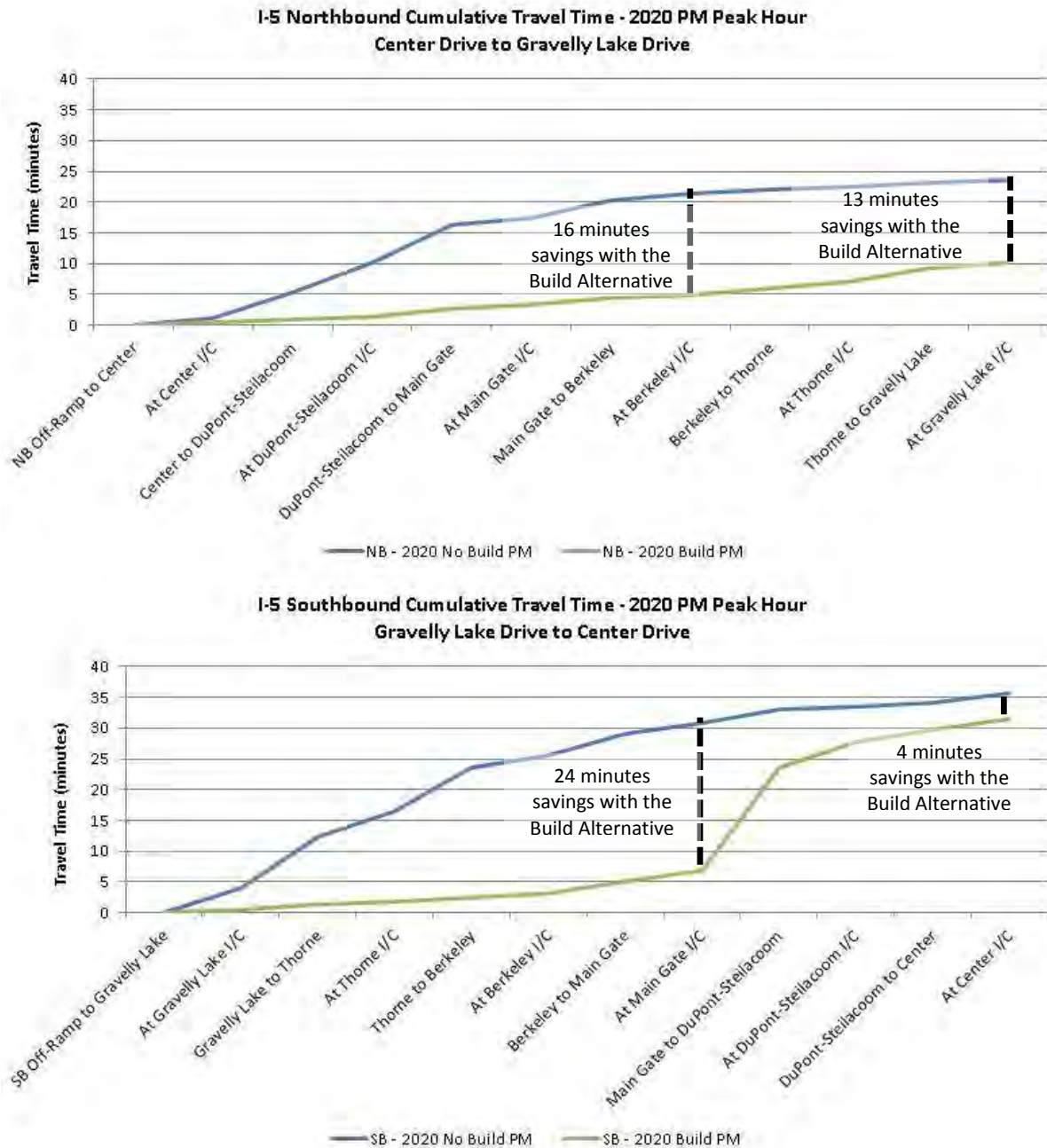

Comparisons of No Build Alternative and Build Alternative travel times along I-5 between Center Drive and Gravelly Lake Drive were made using output from the Mesoscopic Model and

are shown in Figures 45 and 46 for 2020 and 2040 AM and PM peak hours, respectively. Traveling along I-5 between Center Drive and Gravelly Lake Drive at the posted speed limit would require about 8.2 minutes to cover the 8.2 miles between the two interchanges.

As shown on Figure 45, I-5 northbound and southbound travel times during the AM 2020 peak hour between these interchanges would be about the same for the No Build and the Build Alternatives as 2013 conditions (i.e. around eight to nine minutes). Traffic during the time would generally operate near the posted speed limit.

During the 2020 PM peak period, overall southbound travel along I-5 between Center Drive and Gravelly Lake Drive with either the No Build or Build Alternatives would take about 37 to 39 minutes. However, along I-5 north of the Main Gate Interchange, the Build Alternative would show better travel times than the 2013 conditions, and up to 25 minutes shorter travel times than the No Build Alternative. South of the Main Gate Interchange, where Build Alternative speeds are reduced because of the reduction in travel lanes from four lanes to three lanes at Center Drive, travel time are expected to increase relative to the No Build Alternative.

During the 2020 PM peak period, northbound travel along I-5 from Center Drive to Gravelly Lake Drive for the Build Alternative would be slightly better than the 2013 conditions (11 minutes vs 12 minutes) and about 15 minutes shorter compared to the 2020 No Build Alternative (11 minutes vs 26 minutes).

Figure 46 shows the 2040 AM and PM cumulative peak hour travel times along I-5 between Center Drive and Gravelly Lake Drive. During the AM peak hour, travel times with the Build Alternative would be similar to the 2013 conditions with overall travel times between Center Drive and Gravelly Lake Drive between eight and nine minutes. The 2040 No Build Alternative travel times would be about 12 minutes southbound and nine minutes northbound.

During the 2040 PM peak hour, northbound travel times on I-5 with the Build Alternative are expected to be similar to 2013 conditions from Center Drive to Berkeley Street, and then slightly increase such that overall travel time is about 12 minutes in 2013 and would be 18 minutes in 2040. The increase in northbound travel time would be caused by maintaining four lanes through the corridor with the Build Alternative, which allows more volume and results in slower traffic speeds. In 2013, only three lanes are available south of Thorne Lane and the increase to four lane allows northbound traffic to operate at slightly higher speeds. In contrast, travel time with the No Build Alternative is expected to increase to about 34 minutes because of the higher demand with the same number of lanes as with 2013 conditions.

Figure 45: Comparison of No Build vs Build Alternatives for 2020 AM & PM Peak Hour Cumulative Travel Times through the Study Area

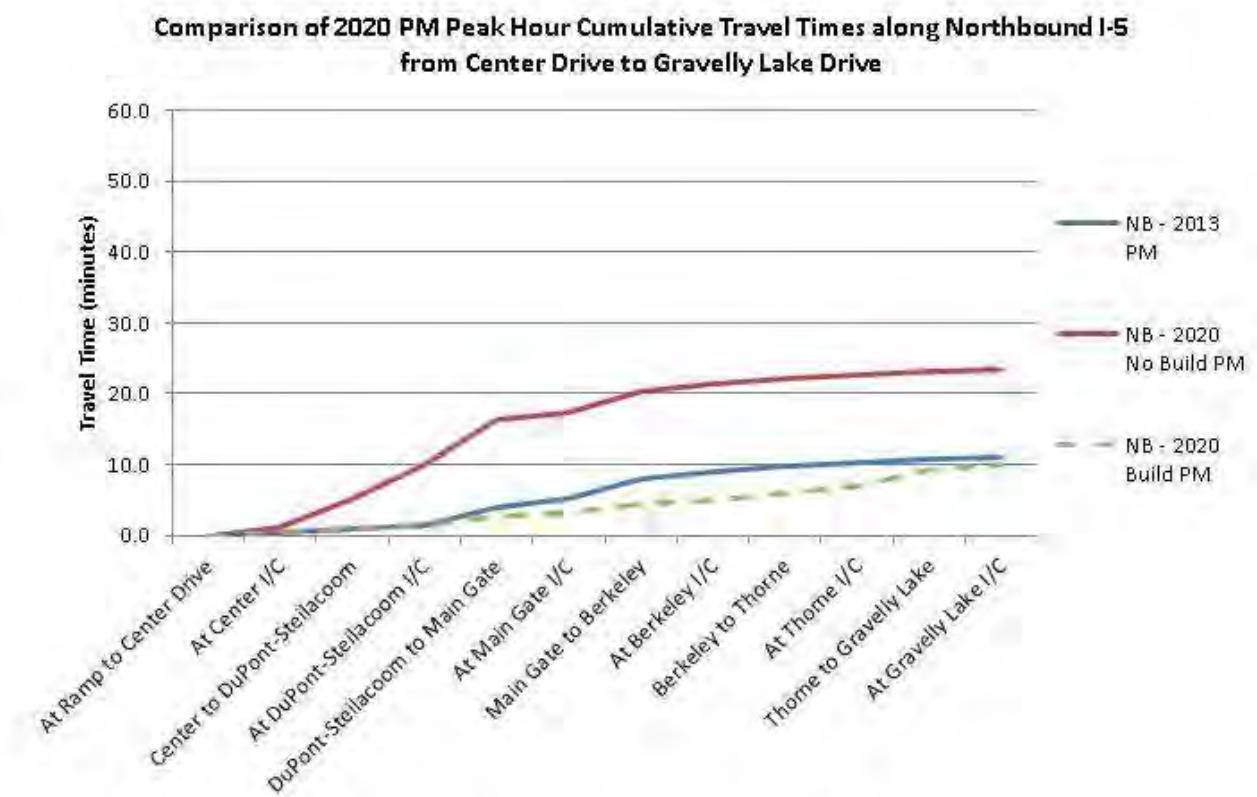
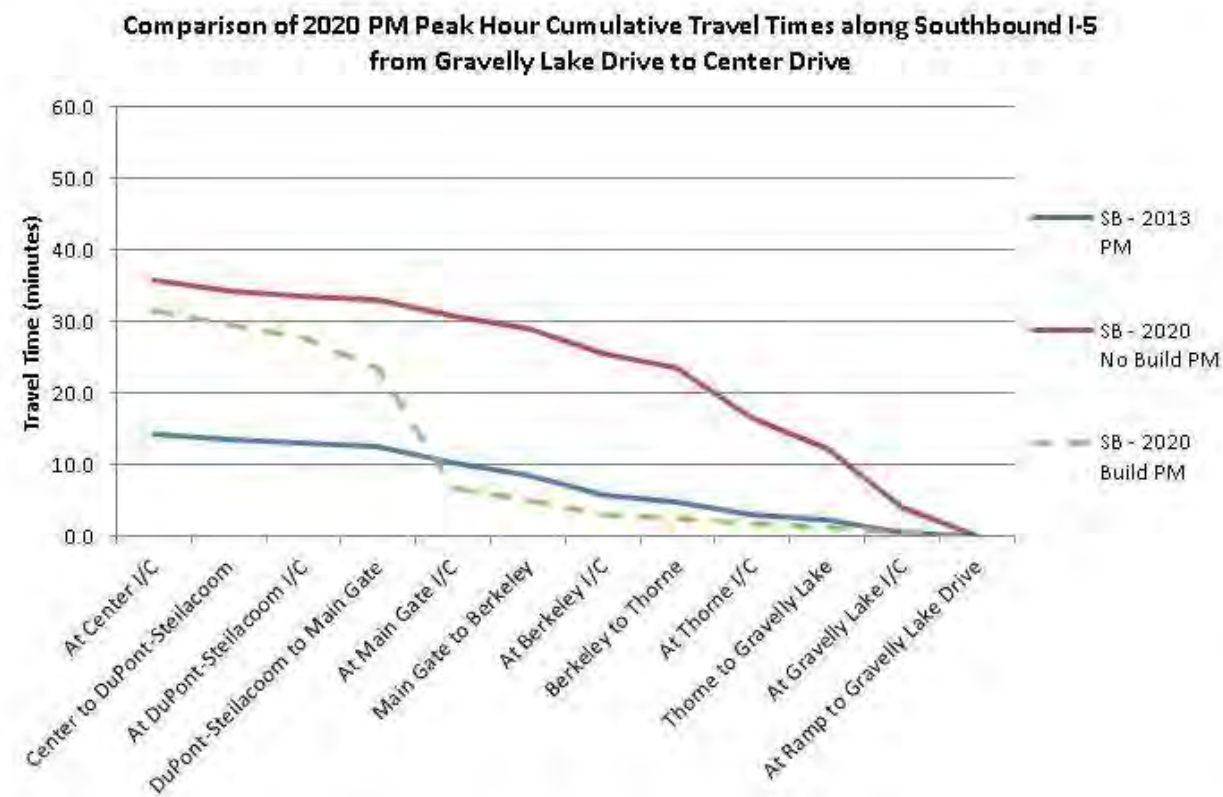
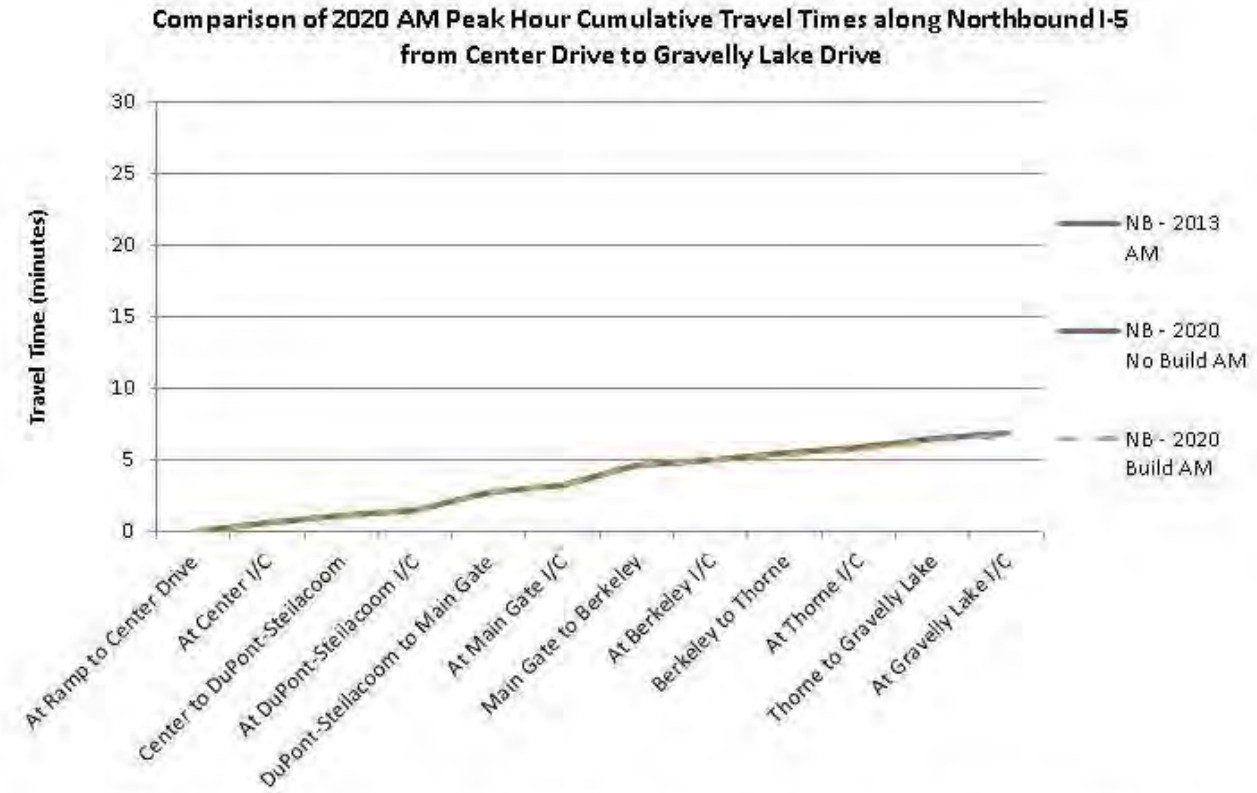
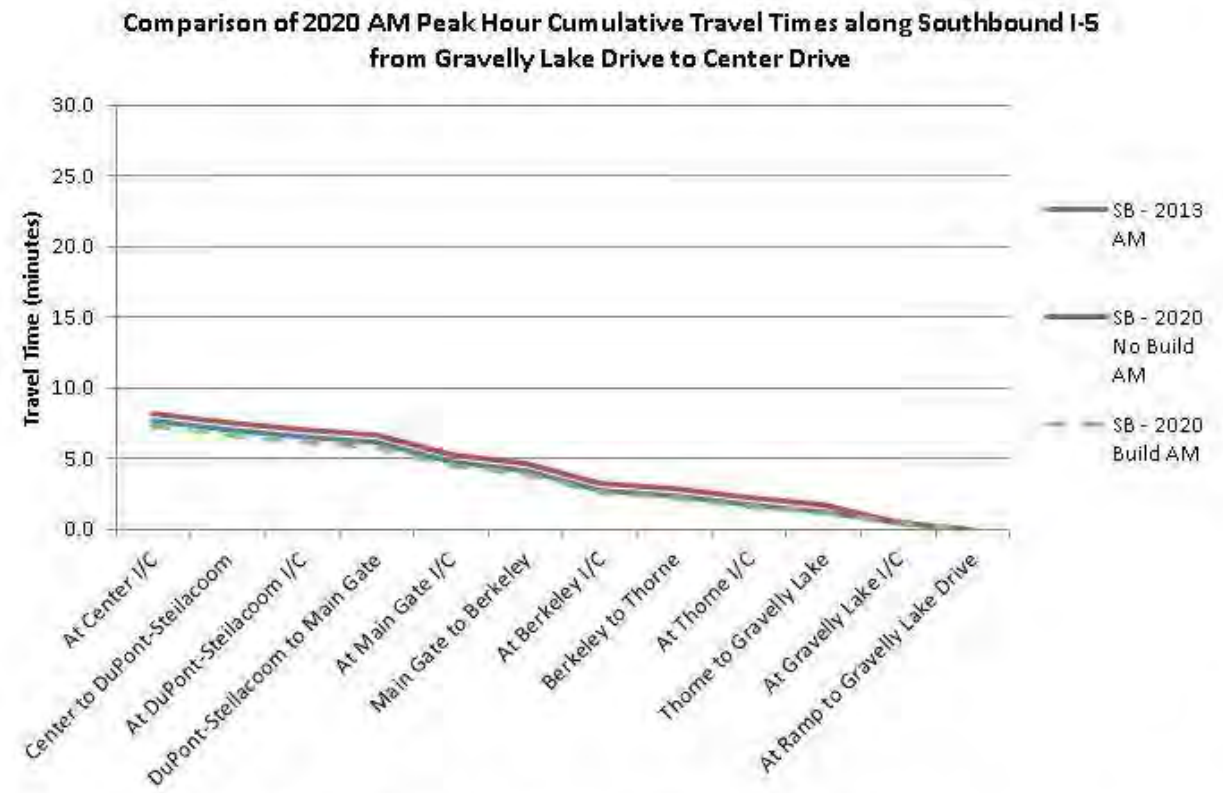
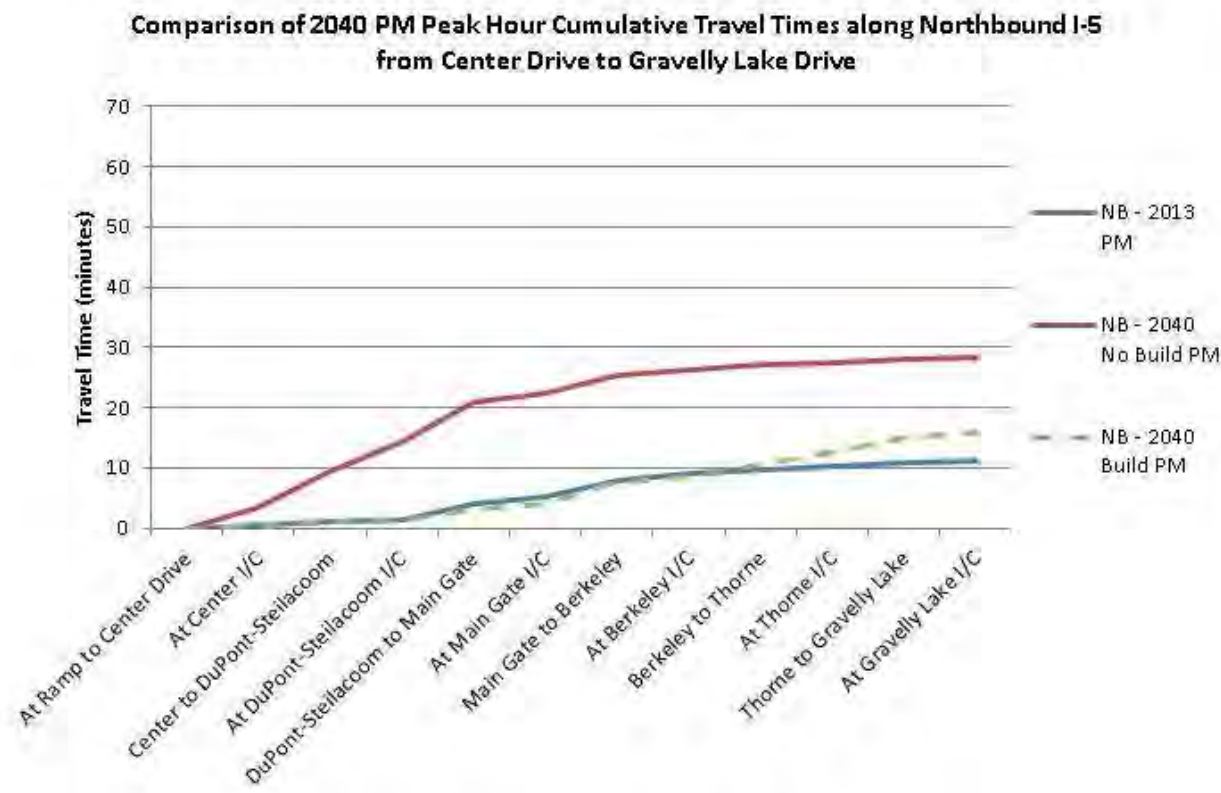
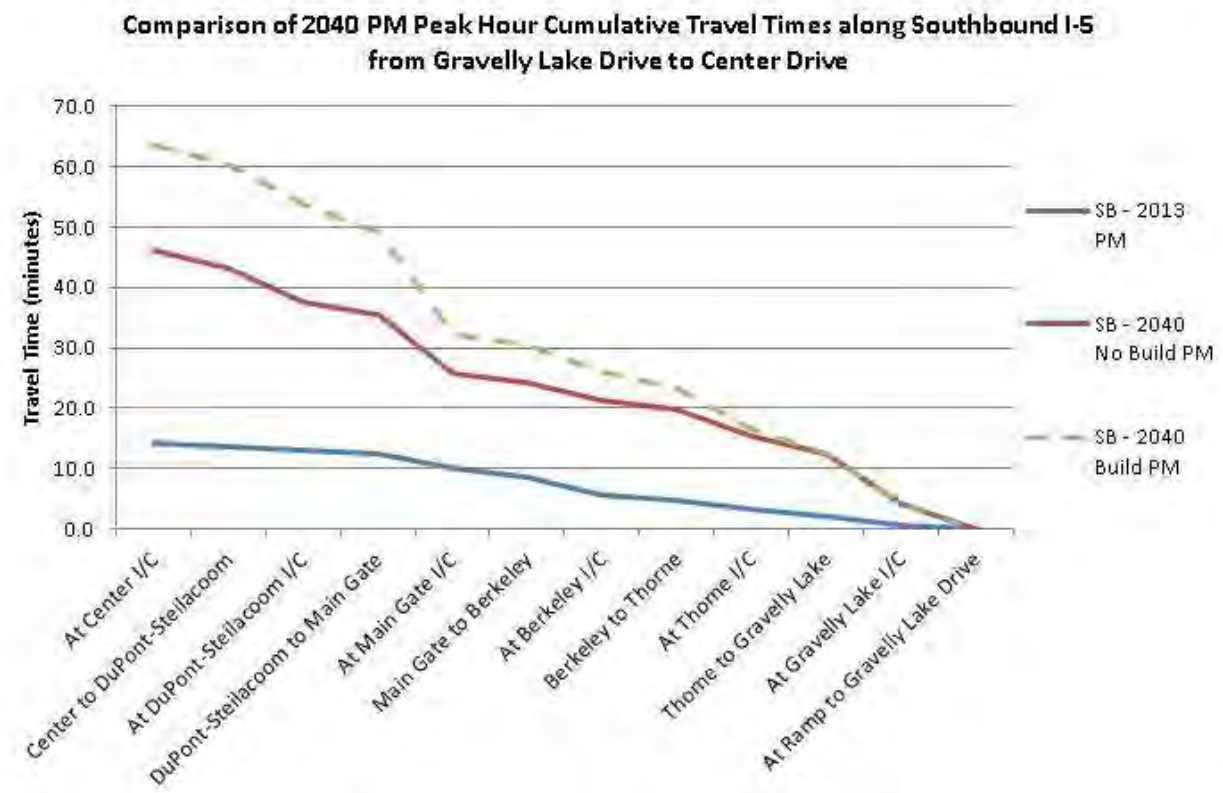
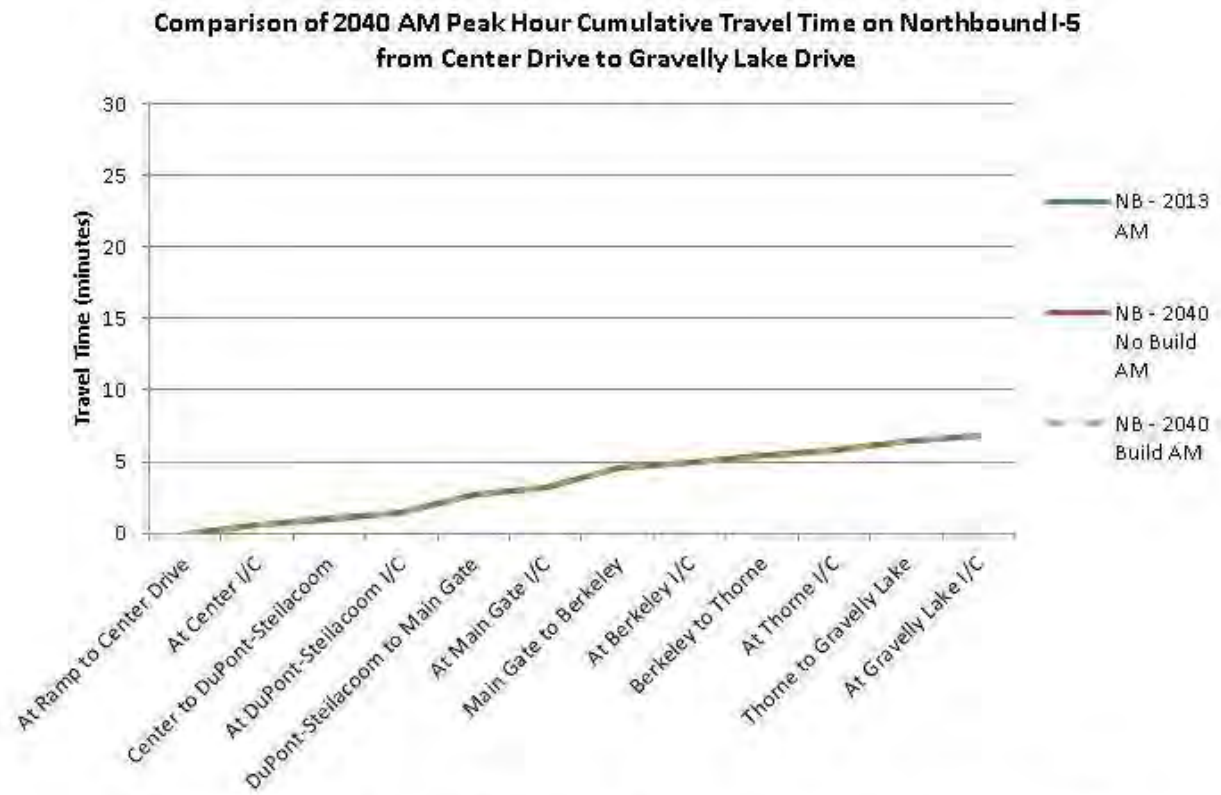
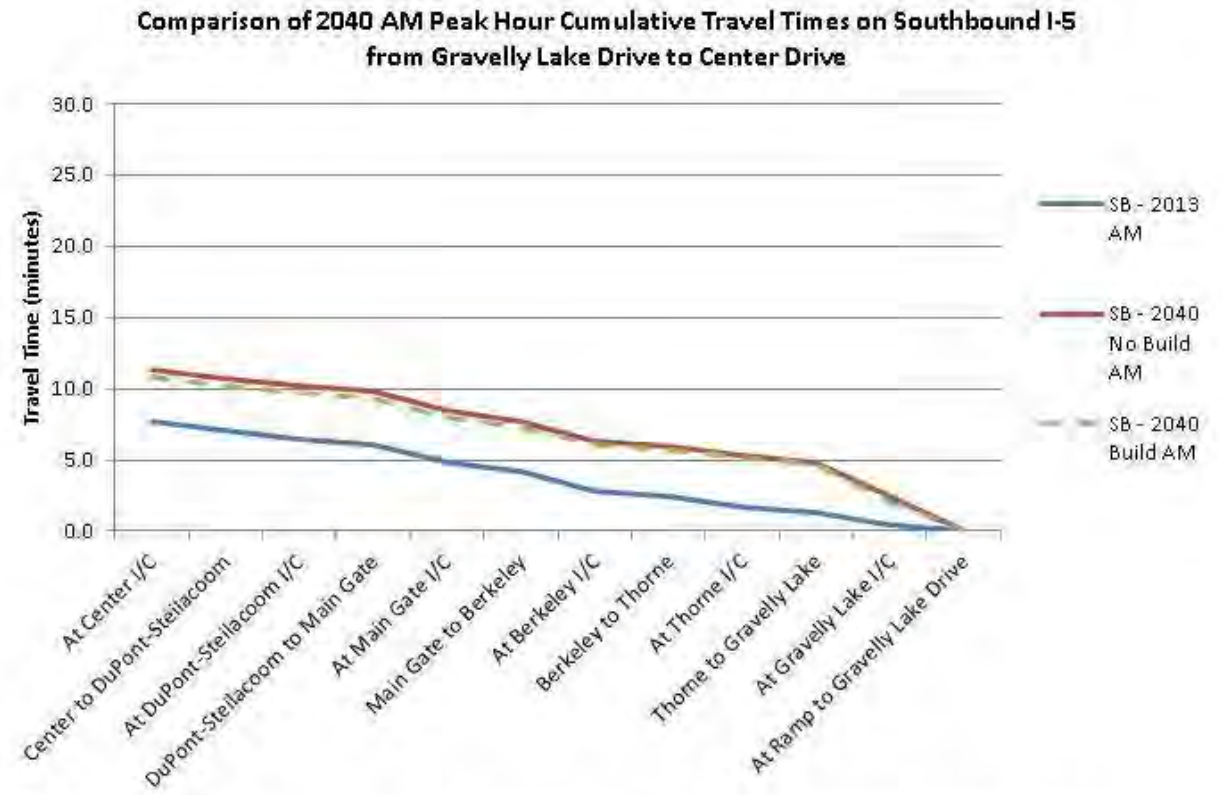

Figure 46: Comparison of No Build vs Build Alternatives for 2040 AM & PM Peak Hour Cumulative Travel Times through the Study Area



Conversely in the southbound direction, 2040 PM peak hour travel times with the Build Alternative are expected to be higher than the No Build Alternative (68 minutes vs 48 minutes). For the Build Alternative, the southbound four-lane to three-lane reduction is moved from Thorne Lane to Center Drive. For the 2040 No Build Alternative, congestion extends southward to around the Main Gate Interchange with some congestion at the Center Drive on-ramp. Because of the lower amount of traffic flowing through the corridor, No Build Alternative travel speeds are slightly higher along the corridor. With the Build Alternative, the reduction in travel lanes at Center Drive would allow more traffic on I-5 but travel speeds would be slower and back-ups would extend throughout the corridor which increases travel times.

8.7 Summary of Future Year Intersection Analysis at I-5 Reconfigured and Adjacent Interchanges for the Build Alternative

The Build Alternative intersection analyses were conducted using Synchro software for signalized and non-signalized intersections and Sidra software for roundabouts for a 2020 opening year and a 2040 design year. Results of the analyses for the two focus interchanges are summarized in Table 6. The analyses show that during the AM and PM peak hours with the revised interchange configurations with roundabouts for the Build Alternative, intersections at the Berkeley Street Interchange and Thorne Lane Interchange all operate at LOS C or better and operate better than the No Build Alternative. A comparison between 2020 AM and PM peak hour LOS results for the No Build and Build Alternatives is presented graphically in Figures 47 and 48.

INTERSECTION LEVEL OF SERVICE (LOS) CRITERIA		
LOS	Signalized Intersection Delay (sec)	Unsignalized Intersection Delay (sec)
A	≤10 sec	≤10 sec
B	10–20 sec	10–15 sec
C	20–35 sec	15–25 sec
D	35–55 sec	25–35 sec
E	55–80 sec	35–50 sec
F	≥80 sec	≥50 sec

Source: 2010 Highway Capacity

The intersection analyses for the Berkeley Street, Thorne Lane and Gravelly Lake Drive intersections used Synchro software for signalized and non-signalized intersections and Sidra software for roundabouts. Turning movement volumes at each intersection were developed through the use of the Meso Model.

Berkeley Street Interchange – In addition to providing grade separation over the adjacent rail line, the proposed Build Alternative reconfiguration for the Berkeley Street interchange with teardrop roundabouts would improve traffic operations at this interchange. Overall, the levels of service at the Berkeley Street intersections are expected to be LOS C or better for the Build Alternative, and the teardrop roundabouts would operate at LOS B or better. For the No Build Alternative, the levels of service at the Berkeley Street intersections with the I-5 ramp would be LOS D or better with the interim Madigan Access improvements.

Table 6: Summary of Interchange Delay and Level of Service (LOS) at the Reconfigured Interchanges—No Build vs. Build Alternative

Intersection*	2020 No Build		2020 Build		2040 No Build		2040 Build	
	AM	PM	AM	PM	AM	PM	AM	PM
<u>I-5 NB Ramps / Berkeley Street</u>								
Control Type	Signal**		Roundabout		Signal**		Roundabout	
Average Delay (sec) / LOS	16.3/B	20.8/C	4.4/A	5.2/A	11.4/B	14.5/B	4.5/A	4.6/A
<u>I-5 SB Ramps / Berkeley Street</u>								
Control Type	Signal**		Roundabout		Signal**		Roundabout	
Average Delay (sec) / LOS	36.0/D	26.0/C	13.2/B	9.1/A	32.4/C	23.8/C	16.7/B	8.7/A
<u>Berkeley Street / Union Avenue**</u>								
Control Type	Signal		2-Way Stop		Signal		2-Way Stop	
Average Delay (sec) / LOS	11.0/B	12.0/B	15.2/C	9.0/A	10.0/B	12.7/B	15.5/C	13.2/B
<u>Berkeley Street / Washington Avenue</u>								
Control Type	2-Way Stop		2-Way Stop		2-Way Stop		2-Way Stop	
Average Delay (sec) / LOS	12.6/B	14.3/B	9.3/A	9.2/A	14.2/B	12.2/B	9.6/A	9.2/B
<u>Berkeley Street / Jackson Avenue Extension</u>								
Control Type	NA		All-way Stop		NA		All-way Stop	
Average Delay (sec) / LOS	NA	NA	13.9/B	23.8/C	NA	NA	12.3/B	10.9/B
<u>I-5 NB Ramps / Thorne Lane</u>								
Control Type	Signal		Roundabout		Signal		Roundabout	
Average Delay (sec) / LOS	34.2/C	37.9/D	5.5/A	7.1/A	37.3/D	36.6/D	7.0/A	11.9/B
<u>I-5 SB Ramps / Thorne Lane</u>								
Control Type	Signal		Roundabout		Signal		Roundabout	
Average Delay (sec) / LOS	33.9/C	47.5/D	8.8/A	14.6/B	49.5/D	44.4/D	12.6/B	17.7/B
<u>Thorne Lane/Union Avenue Loop (New Intersection)</u>								
Control Type	NA		Roundabout		NA		Roundabout	
Average Delay (sec) / LOS	NA	NA	6.5/A	21.1/C	NA	NA	6.9/A	9.1/A
<u>Thorne Lane / Union Avenue (with Gravelly-Thorne Connector for Build Alternative)</u>								
Control Type	2-way Stop		2-way Stop		2-way Stop		2-way Stop	
Average Delay (sec) / LOS	10.4/B	11.6/B	9.6/A	11.2/B	11.2/B	12.8/B	9.6/A	12.0/B

Notes* Signalized & non-signalized intersections analyzed using Synchro software and Highway Capacity Manual procedures. Please note that the Synchro analysis does not account for back-ups on on-ramp from the ramp meter or freeway.
 ** Assumes Madigan Access Improvements at the Berkeley Street Interchange are implemented with the No Build Alternative by 2020.

Thorne Lane Interchange – The proposed Build Alternative reconfiguration with teardrop roundabouts at the I-5 ramps and grade separation over the adjacent rail line would improve traffic operations at this interchange. At the Thorne Lane intersections with the I-5 ramps, the levels of service for the No Build Alternative would generally be at LOS D or better. The reconfigured Build Alternative interchange is expected to operate at LOS B or better through 2040. Results of the intersection analyses for the adjacent interchanges at Center Drive, Steilacoom-DuPont Road and Gravelly Lake Drive are summarized in Table 7.

Figure 47: 2020 AM and PM Peak Hour Levels of Service for the No Build and Build Alternatives

PEAK HOUR LEVELS OF SERVICE – 2020

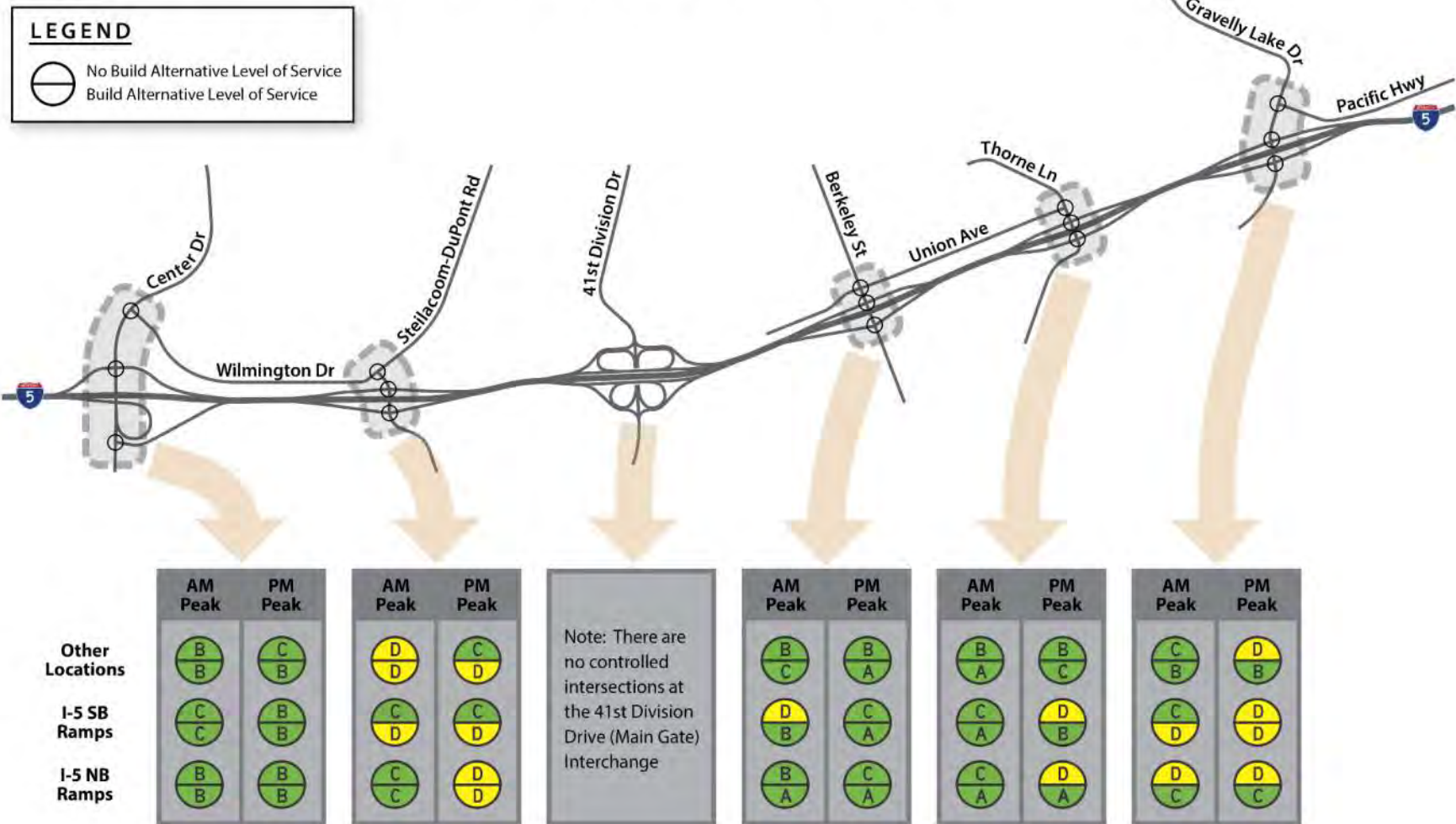

Figure 48: 2040 AM and PM Peak Hour Levels of Service for the No Build and Build Alternatives

PEAK HOUR LEVELS OF SERVICE - 2040

LEGEND

 No Build Alternative Level of Service
 Build Alternative Level of Service

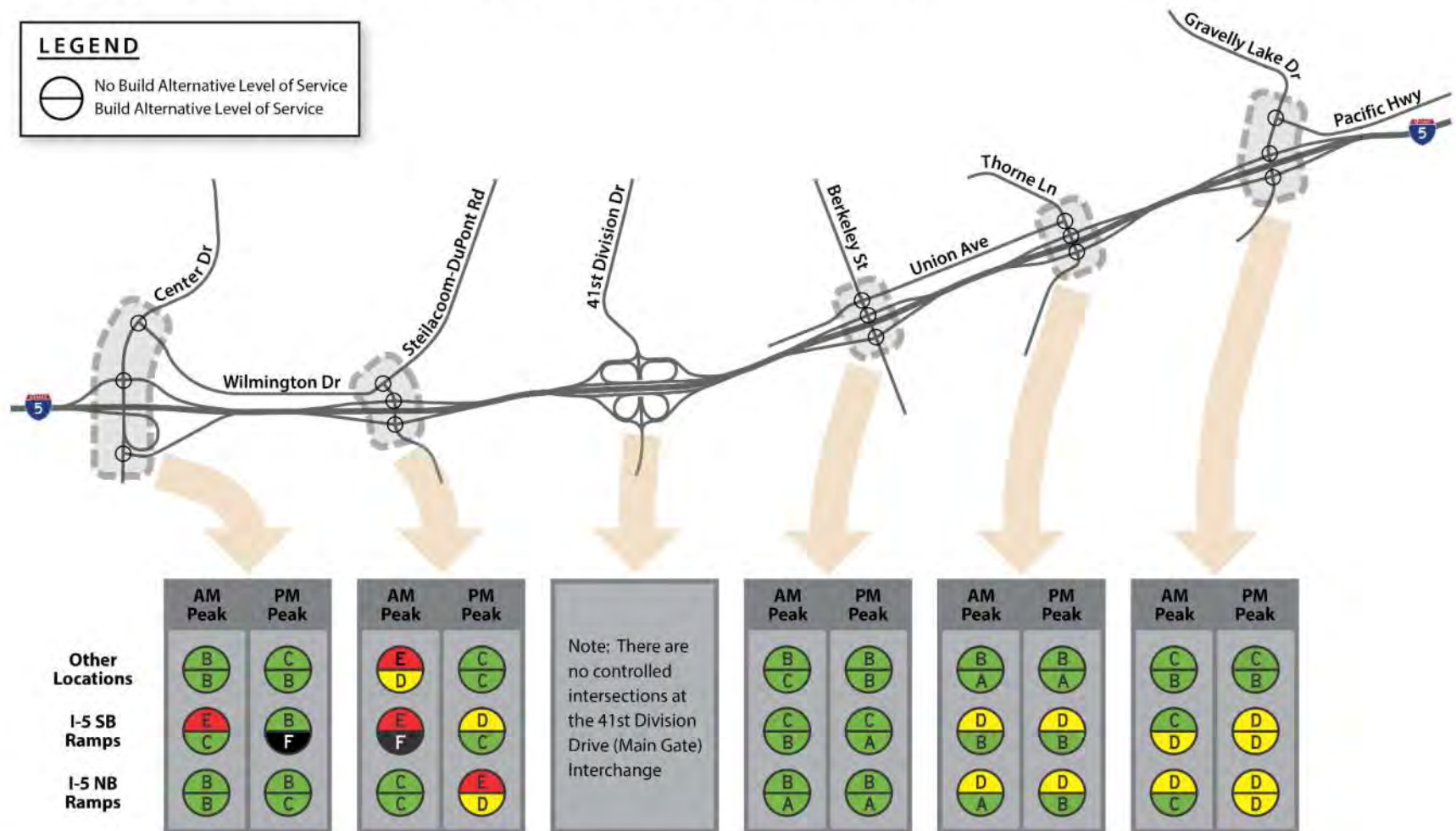

Table 7: Summary of Interchange Delay and Level of Service (LOS) at Other Area Interchanges—No Build vs. Build Alternatives

Intersection*	2020 No Build		2020 Build		2040 No Build		2040 Build	
	AM	PM	AM	PM	AM	PM	AM	PM
<u>I-5 NB Ramps / Center Drive**</u>								
Control Type	2-way Stop		2-way Stop		2-way Stop		2-way Stop	
Average Delay (sec) / LOS	12.3/B	12.7/B	12.2/B	10.9/B	12.0/B	11.9/B	13.3/B	15.0/C
<u>I-5 SB Ramps / Center Drive</u>								
Control Type	2-way Stop		2-way Stop		2-way Stop		2-way Stop	
Average Delay (sec) / LOS	18.6/C	13.3/B	15.3/C	11.4/B	35.0/E	13.2/B	21.0/C	63.1/F
<u>Center Drive / Wilmington Drive</u>								
Control Type	Signal		Signal		Signal		Signal	
Average Delay (sec) / LOS	14.1/B	20.2/C	13.0/B	18.6/B	18.4/B	20.2/C	13.7/B	18.7/B
<u>I-5 NB Ramps / Steilacoom-DuPont Road</u>								
Control Type	Signal		Signal		Signal		Signal	
Average Delay (sec) / LOS	22.5/C	45.1/D	22.3/C	43.8/D	29.7/C	57.9/E	28.6/C	49.3/D
<u>I-5 SB Ramps / Steilacoom-DuPont Road</u>								
Control Type	Signal		Signal		Signal		Signal	
Average Delay (sec) / LOS	34.0/C	29.1/C	37.2/D	41.2/D	68.7/E	37.5/D	82.2/F	30.9/C
<u>Steilacoom-DuPont Road / Barksdale Avenue / Wilmington Drive</u>								
Control Type	Signal		Signal		Signal		Signal	
Average Delay (sec) / LOS	36.9/D	27.1/C	46.9/D	37.4/D	58.2/E	26.6/C	50.3/D	28.5/C
<u>I-5 NB Ramps / Gravelly Lake Drive</u>								
Control Type	Signal		Signal		Signal		Signal	
Average Delay (sec) / LOS	46.5/D	46.1/D	24.0/C	35.0/C	35.4/D	49.6/D	26.1/C	50.2/D
<u>I-5 SB Ramps / Gravelly Lake Drive</u>								
Control Type	Signal		Signal		Signal		Signal	
Average Delay (sec) / LOS	31.3/C	37.2/D	38.4/D	37.9/D	32.8/C	40.8/D	47.0/D	39.3/D
<u>Gravelly Lake Drive / Pacific Highway</u>								
Control Type	Signal		Signal		Signal		Signal	
Average Delay (sec) / LOS	32.0/C	37.1/D	12.6/B	17.9/B	34.6/C	34.7/C	15.8/B	12.8/B

Notes: * Signalized & non-signalized intersections analyzed using Synchro software and Highway Capacity Manual procedures
Please note that the Synchro analysis does not account for back-ups on on-ramp from the ramp meter or freeway.

** The I-5 NB Ramps / Center Drive intersection was redesigned in 2015. This new design is reflected in the 2020 and 2040 analysis.

Center Drive – For the northbound and southbound ramp intersections at Center Drive for the Build Alternative, the Synchro analyses show that these intersections would operate at LOS C or better in 2020 and 2040 during the AM and PM peak hours, except that the I-5 southbound ramp intersection for the Build Alternative is expected to operate at LOS E in the PM Peak hour. However, the Synchro analysis does not account for back-ups from the ramp meter on the southbound on-ramp.

For both the No Build and Build Alternatives, traffic at the Center Drive southbound on-ramp is expected to back-up from the ramp meter through the I-5 southbound ramp intersection with Center Drive and then westbound along Center Drive and through the signalized intersections at Wilmington Drive and McNeil Street. Figure 49 shows the 2020 PM peak hour queue back-ups along Center Drive from the I-5 southbound ramp intersection with Center Drive and along Wilmington Drive west of Center Drive.

With the Build Alternative, queues along Center Drive would increase by about 1,050 feet, and along Wilmington Drive by about 325 feet. The increases in traffic queues along Center Drive and Wilmington Drive with the Build Alternative would be partially due to traffic re-routing in the area caused mainline congestion north of Center Drive, and the reduction of I-5 travel lanes at Center Drive from four lanes to three lanes.

To provide a quantitative assessment of expected future traffic operations at this location that does account for the effects of traffic queuing, further analysis was conducted using the Meso Model (Dynameq). Results are presented in Table 8.

Steilacoom-DuPont Road – For the No Build Alternative, the level of service at the northbound Steilacoom-DuPont Road intersection with the I-5 ramps is expected to be LOS D during the AM peak hour, but dropping to LOS F during the PM peak hour. LOS C is expected at the southbound ramp intersection during the AM peak hour, dropping to LOS D during the PM peak hour. For the Steilacoom-DuPont Road intersection with Barksdale Avenue and Wilmington Drive, the level of service is expected to be LOS C during the AM peak hour, dropping to LOS F during the PM peak hour.

With the Build Alternative, the northbound ramp intersection is expected to operate at LOS C during the AM peak hour and LOS E during the PM peak hour. Operations would improve to LOS C or better at the southbound ramp intersection during both the AM and PM peak hours. At Barksdale Avenue and Wilmington Drive, the AM peak hour is expected to operate at LOS C, dropping to LOS E during the PM peak hour.

Gravelly Lake Drive – During the 2020 AM and PM peak hours, the ramp intersections at Gravelly Lake Drive are expected to operate at LOS D or better for both the No Build and Build Alternatives. At the intersection of Gravelly Lake Drive and Pacific Highway, the PM peak hour LOS would be D or better for the No Build Alternative, but is expected to improve to LOS B with the Build Alternative.

A more detailed summary of the intersection analyses for the Build Alternative, including turning movements for both the Synchro analyses and from the Mesoscopic Model, is contained in Appendix F.

Figure 49: Comparison of No Build vs. Build Alternatives 2020 PM Peak Hour of 95 % Traffic Queues along Center Drive and Wilmington Drive in DuPont

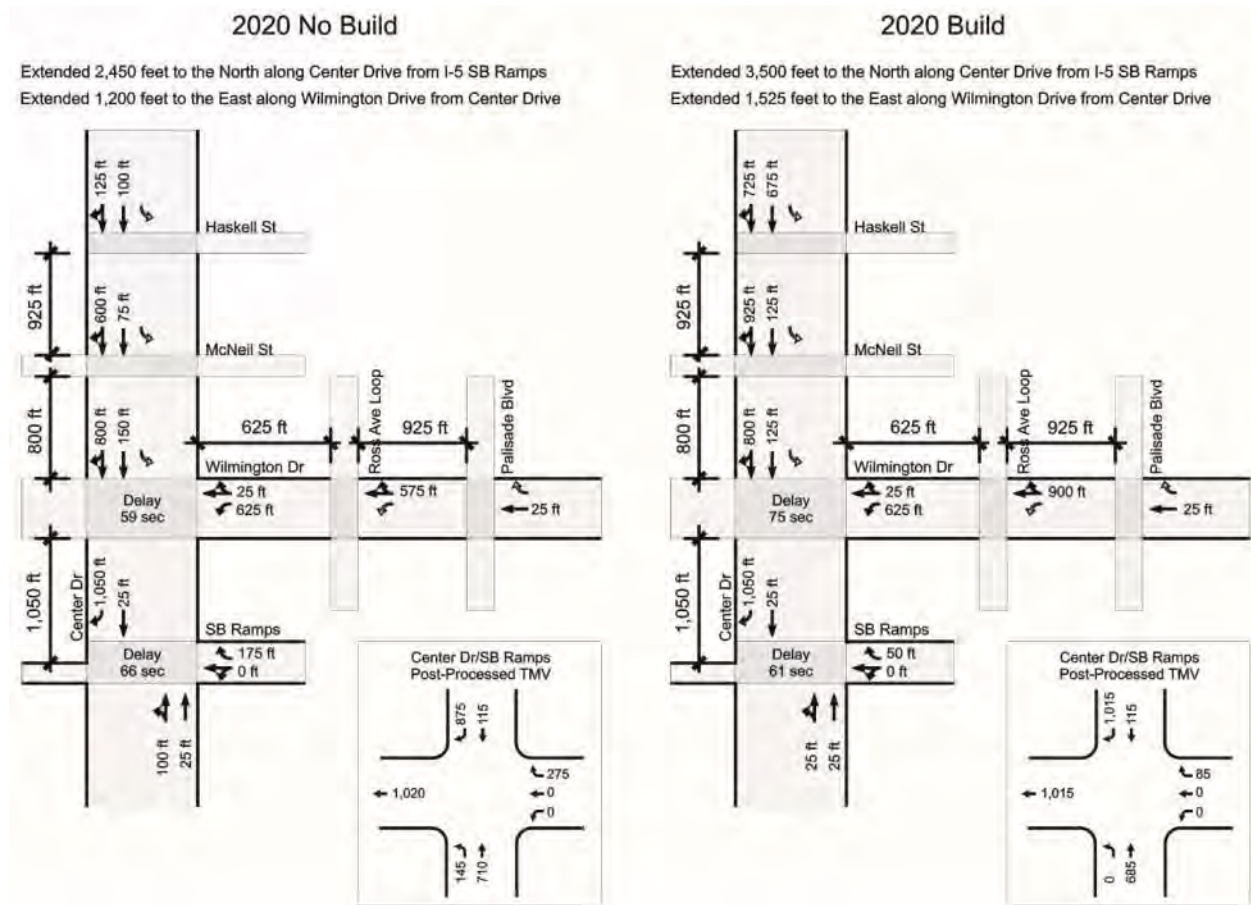

Table 8: 2020 AM and PM Peak Hour Intersection Level of Service at Center Drive Interchange using Meso Model – No Build and Build Alternatives

Intersection *	2020 No Build		2020 Build	
	AM	PM	AM	PM
I-5 NB Ramps/Center Drive** (2-Way Stop)				
Average Delay (sec) / LOS	8/A	4/A	2/A	5/A
I-5 SB Ramps/Center Drive (2-Way Stop)				
Average Delay (sec) / LOS	10/B	66/F	2/A	61/E
Center Drive/Wilmington Drive(Signal)				
Average Delay (sec) / LOS	9/A	59/E	9/A	75/E

Notes: * Intersection operations analysis is based on direct output from the Meso Model which reflects impacts of traffic queuing through adjacent intersection.

** The I-5 NB Ramps / Center Drive intersection was redesigned in 2015. This new design is reflected in the 2020 and 2040 analysis.

LOS E and LOS F values shown in bold.

Main Gate/41st Division Drive Interchange - As the I-5 / Main Gate interchange ramp terminals have no signalized or stop-controlled intersections, a separate analysis was conducted for the cloverleaf design at this interchange, focusing on the ramp connections to 41st Division Drive. Analysis was conducted using output from the Meso Model, as shown in Table 9. The analysis shows that the northbound approach along 41st Division Drive would have long delays (nearly five minutes) at the northbound ramp connections for the No Build Alternative in the PM peak hour, while there would be minimal delay on the other approaches. At the southbound ramp connections, delays would be less than 30 seconds on all approaches.

For the Build Alternative, traffic operations are expected to improve with delays of less than 37 seconds for all approaches at the northbound ramp connections to 41st Division Drive. The southbound ramp connections would have slightly lower delays of approximately 25 seconds or less for all approaches along 41st Division Drive. Overall, the Main Gate interchange is expected to perform better and to experience lower average delays than with the No Build Alternative.

Table 9: 2020 Delay Summary at Main Gate Interchange – No Build vs. Build Alternative

Approach	2020 No Build		2020 Build	
	Volume AM/PM	Delay (seconds per vehicle) AM/PM	Volume AM/PM	Delay (seconds per vehicle) AM/PM
NB I-5 Ramp / 41st Division Drive				
NB on 41 st Division Drive	710/1,835	4.7/294	735/1,395	4.0/36.4
SB on 41 st Division Drive	1,220/1,075	0.3/1.6	1,220/995	0.4/13.8
EB on I-5 NB Off-ramp	305/50	0.0/0.0	300/80	0.0/0.0
WB on I-5 NB Loop Off-ramp	75/25	0.0/0.0	65/40	0.0/0.0
SB I-5 Ramp / 41st Division Drive				
NB on 41 st Division Drive	525/1,425	0.3/0.9	530/915	0.4/24.6
SB on 41 st Division Drive	1,015/1,435	2.5/28.2	1,060/990	2.1/3.2
EB on I-5 NB Loop Off-ramp	390/50	0.8/0.7	345/125	0.7/0.3
WB on I-5 NB Off-ramp	120/50	0.5/0.0	135/165	0.5/9.9

8.8 Summary of 2020 and 2040 I-5 Traffic Conditions in the JBLM vicinity

A summary of the key findings from the I-5 traffic operation analysis of the No Build Alternative and the Build Alternative in 2020 and 2040 include:

- Traffic demand along I-5 in the JBLM area remains high but the Build Alternative accommodates a higher percent of trip demand during the PM peak hours than the No

Build Alternative (92.6 percent vs 71.4 percent in 2020 and 49.0 percent vs 30.4 percent in 2040).

- 2020 PM northbound I-5 travel speeds average 44 mph with the Build Alternative and 19 mph with the No Build Alternative.
- 2020 PM southbound I-5 travel speeds average about 13 mph for both the Build and No Build Alternatives.
- 2040 PM northbound I-5 travel speeds average 27 mph with the Build Alternative and 15 mph with the No Build Alternative.
- 2040 PM southbound I-5 travel speeds average about 7 mph for the Build Alternative and about 10 mph for the No Build Alternative. The slightly lower Build Alternative average speed is caused by moving the reduction in travel lanes from Thorne Lane for the No Build Alternative to Center Drive for the Build Alternative. This change causes slower southbound traffic through most of the study area, whereas the No Build Alternative causes more back-up outside the study area.
- The No Build Alternative has congestion lasting for up to 4.5 hours through most of the study area, whereas the Build Alternative has congestion lasting between two and four hours during the six-hour PM peak analysis period.
- High levels of exiting and entering traffic from several ramps cause drivers to shift lanes frequently, resulting in slow travel speeds for both the No Build Alternative and the Build Alternative.
- Average AM travel times in 2020 along the I-5 corridor between Center Drive and Gravelly Lake Drive are lower in both directions with the Build Alternative as compared to the No Build Alternative.
- Average PM travel times in 2040 along the I-5 corridor between Center Drive and Gravelly Lake Drive are lower in the northbound direction with the Build Alternative as compared to the No Build Alternative. However, in the PM southbound direction average travel times are higher for the Build Alternative, because of the higher demand, moving the lane reduction to Center Drive, and the high merging traffic from Center Drive.
- With the interchange improvements at Steilacoom-DuPont Road, Berkeley Street and Thorne Lane, intersection operations are at LOS C or better in both 2020 and 2040 for the Build Alternative; whereas several ramp intersections are at LOS E or F with the No Build Alternative.

9.0 I-5 Collision Analysis

A five-year collision analysis was conducted along the I-5 mainline from milepost (MP) 117.42 (south of the Center Drive Interchange) to MP 124.79 (north of the Gravelly Lake Drive Interchange) using data from January 2010 through December 2014. This analysis of mainline, ramp and cross street collisions within the limited access area included a review of the existing collision rate, location, severity, type, and contributing factors.

“Under Section 409 of Title 23 of the United States Code, any collision data furnished is prohibited from use in any litigation against state, tribe or local government that involves the location(s) mentioned in the collision data.”

During this five-year period there were 1,963 reported collisions along the I-5 corridor, an average of more than one collision per day. Approximately 84 percent occurred on the I-5 mainline with 16 percent occurring at the six interchanges between Center Drive and Gravelly Lake Drive and in the limited-access segments of the cross streets, as indicated by Figure 50.

Figure 50: Number of I-5 Collisions - Number of I-5 Collisions Center Drive to Gravelly Lake Drive -- 2010 to 2014

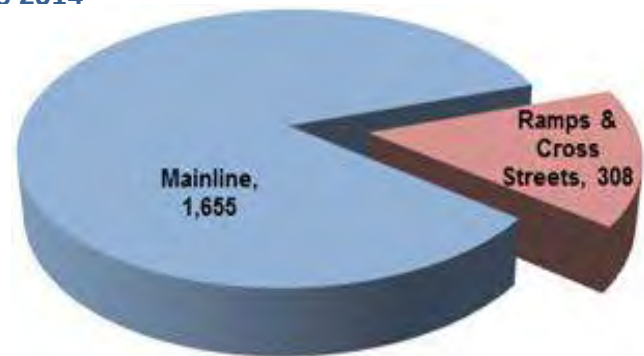

9.1 Collision Rates

A summary of the annual collision rates by severity of collisions along the I-5 mainline is shown in Table 10. Table 10 shows the total collisions along the mainline, ramps and all cross-streets within the limited access area.

Table 10: Collision Summary on I-5 from Center Drive to Gravelly Lake Drive

Severity of Collisions Mainline, Ramps and Cross Streets	2010 to 2014 Collisions	Average Annual Collisions	Collision Rate per 100 MVMT *
Fatal	3	0.6	0.17
Serious Injuries	19	3.8	1.06
Evident Injuries	105	21.0	5.83
Possible Injuries	430	86.0	24.16
Property Damage Only	1,401	280.2	77.83
All Crashes	1,963	392.6	109.04

*100 MVMT = 100 Million Vehicle Miles Traveled

The average collision rates on I-5 through the JBLM area, based on available data, are below the Pierce County collision rate for all highways (177.5 collisions per 100 MVMT), as documented in WSDOT’s 2013 Annual Collision Summary. Fatalities and serious injury rates are also below the county wide averages of 0.62 fatalities per 100 MVMT and 3.36 serious injuries per 100 MVMT.

WSDOT has also conducted a safety assessment for all state highways in Washington State. Based on WSDOT’s 2015 safety assessment, using 2009-2013 data, WSDOT identified four Collision Analysis Segments (CAS) located on I-5 within the study area, as shown in Table 11. One is in the vicinity of Center Drive, two are near Steilacoom-DuPont Road and one is from Thorne Lane to Bridgeport Way. The recently completed Tiger III improvements can improve these locations, but two years of data are needed to assess the effectiveness of the ramp meters and other improvements.

Table 11: Location of I-5 Mainline, Ramp and Cross Street Collision Summary

Highway	From Location	To Location
I-5	NB off-ramp to Center Drive Gore MP 117.79	0.18 miles north of Center Drive bridge MP 118.14
I-5	Bridge over Railroad to JBLM MP 118.37	At SB on-ramp from Steilacoom-DuPont Road MP 118.64
I-5	At SB on-ramp from Steilacoom-DuPont Road MP 118.64	Bridge over Pendleton Avenue MP 119.38
I-5	SB Off-ramp to Thorne Lane MP 123.94	Bridge over Clover Creek near Bridgeport Way MP 125.64

9.2 I-5 Mainline Collision

The locations of collisions along the I-5 mainline and the time of day they occur over the five-year period from 2010 through 2014 are discussed below.

Location of I-5 Collisions: With 84 percent (1,635 collisions of five years) of the collisions between Center Drive and Gravelly Lake Drive occur along the I-5 mainline, an analysis was conducted to determine the location of collisions. Figure 51 shows the location and number of collisions along the I-5 corridor by milepost in both directions over the five-year period from January 2010 through December 2014. With the close proximity of interchanges and heavy merging and existing volumes, many of the collisions occur near the interchange on- and off-ramps, or as drivers merge across traffic to change lanes. At the Thorne Lane Interchange, southbound collisions are high because of the outside lane becoming an exit only lane and through traffic in this lane must change lanes to continue south.

Collisions by Time of Day: Figure 52 shows the distribution of mainline collision by time of day over the five year (2010 to 2014) period along I-5 between Center Drive and Gravelly Lake Drive. Approximately 14 percent of the collision along I-5 occur between 5:00 AM and 7:00 AM, and over 48 percent of the collisions occur between 3:00 PM and 7:00 PM. These times of collision generally correspond AM and PM peak travel times with the most congestion

Figure 51: I-5 Mainline Collisions by Milepost

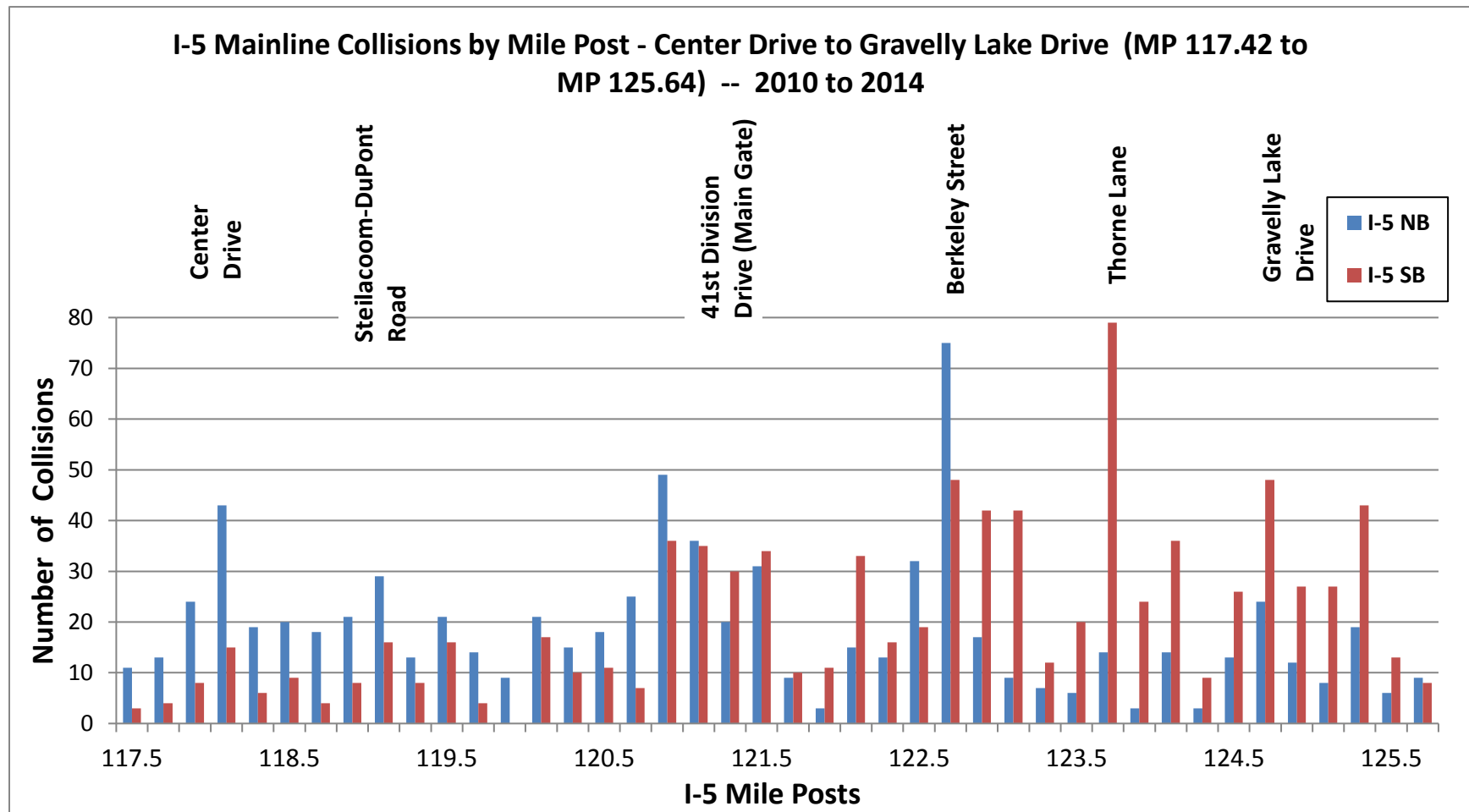

Note: Under Section 409 of Title 23 of the United States Code, any collision data furnished is prohibited from use in any litigation against state, tribe or local government that involves the location(s) mentioned in the collision data.”

Figure 52: Distribution of I-5 Collisions by Time of Day between Center Drive and Gravelly Lake Drive

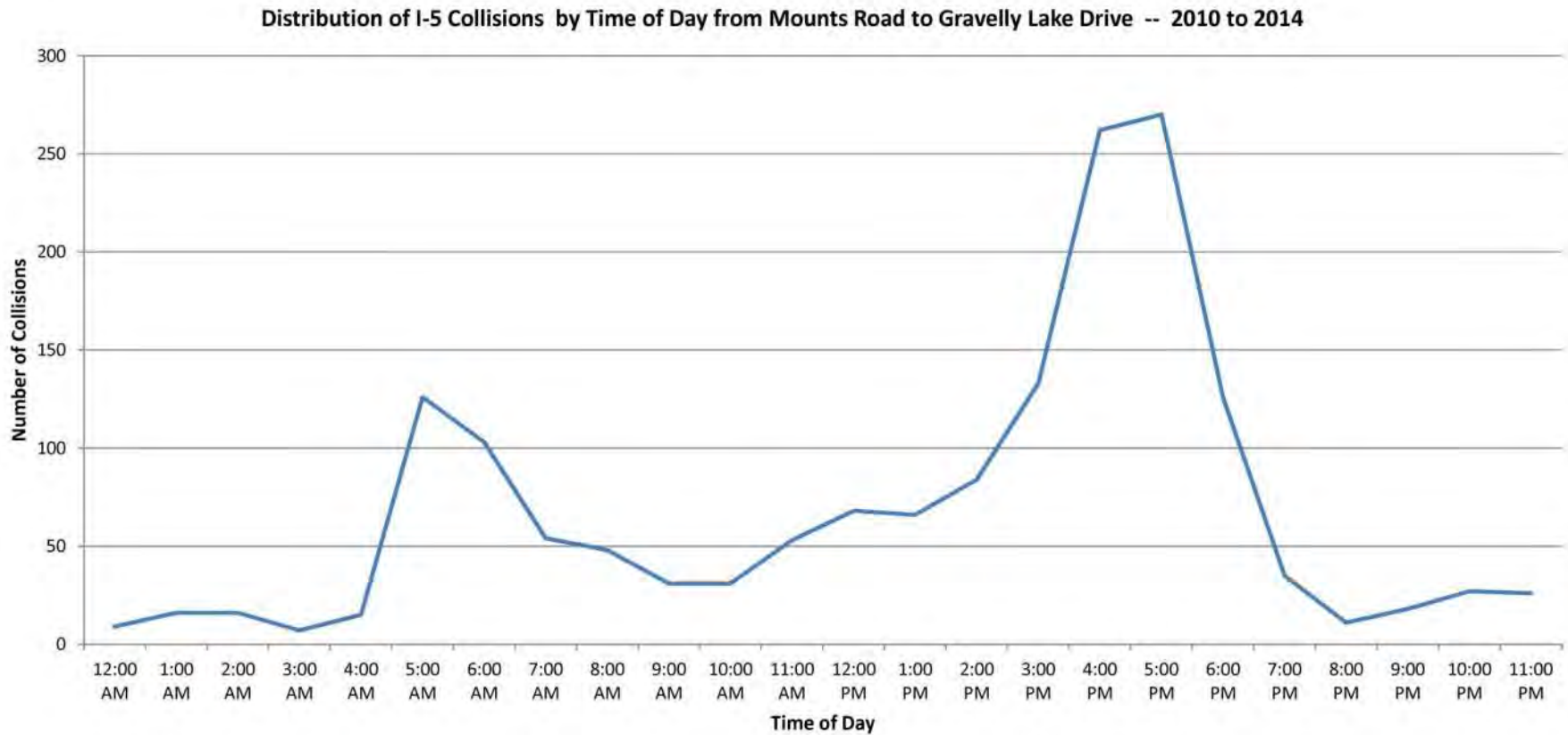

Note: Under Section 409 of Title 23 of the United States Code, any collision data furnished is prohibited from use in any litigation against state, tribe or local government that involves the location(s) mentioned in the collision data.”

9.3 Severity, Type and Contributing Circumstance for I-5 Collisions

An analysis of all I-5 collisions, including mainline, ramp and cross street collisions, between Center Drive and Gravelly Lake Drive was conducted to determine the severity, types, and contributing circumstances of the collisions.

Severity of I-5 Collisions: The severity of the I-5 collisions is summarized in Figure 53.

Collisions involving property damage only (no injuries) make up the majority (nearly 72 percent) of the collisions with almost 83 percent of these collisions occurring along the I-5 corridor between Center Drive and Gravelly Lake Drive. Three fatalities occurred along I-5 during the five-year study period and 19 collisions involved serious injuries.

Types of I-5 Collisions: As shown in Figure 54, nearly 70 percent of collisions along the I-5 corridor between Center Drive and Gravelly Lake Drive were rear-end collisions and almost 20 percent were sideswipe collisions. About seven percent of the collisions involve hitting fixed objects, such as median barriers, guardrails, retaining walls, fences, bridges, and ditches. The rear-end and sideswipe collisions are common occurrences in congested stop-and-go conditions, like I-5 through the study area with heavy entering and exiting traffic and drivers frequently changing lanes.

Figure 53: Severity of I-5 Collisions – Center Drive to Gravelly Lake Drive – 2010 to 2014

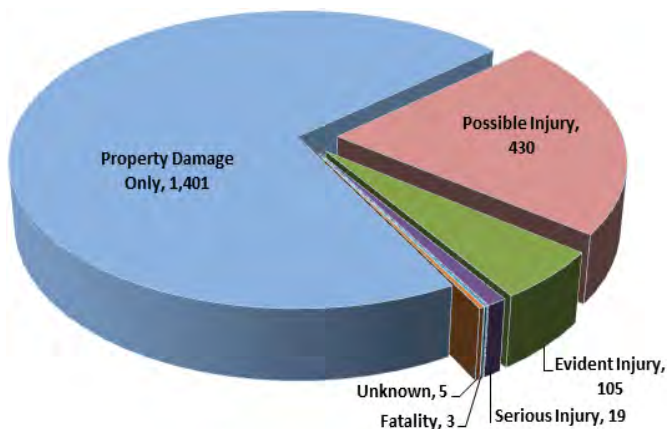
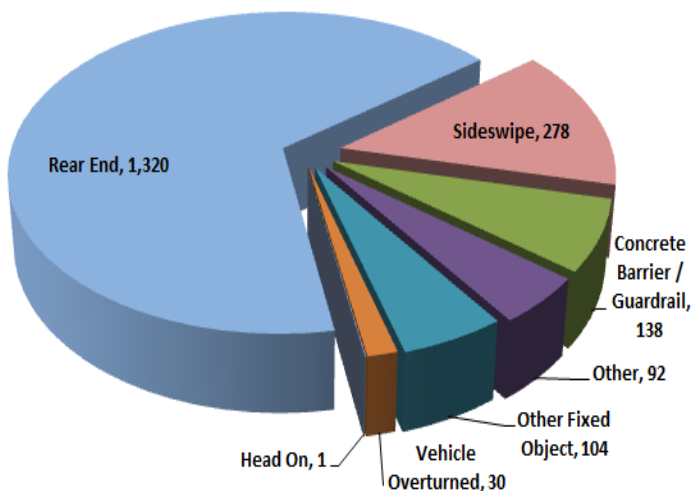

Figure 54: I-5 Collisions by Type – Center Drive to Gravelly Lake Drive – 2010 to 2014



Contributing Circumstances

for I-5 Collisions: Based on existing collision data, there are several circumstances that contribute to the collisions along the I-5 corridor between Center Drive and Gravelly Lake Drive, as shown on Figure 55. Exceeding reasonable speeds, following too closely, and driver inattention are three factors that contribute to 71 percent of the collisions that have occurred along this section of I-5. Drivers who were distracted or did not grant others the right of way to merge or change lanes contributed another 12 percent of the collisions along the I-5.

Figure 55: Contributing Circumstances for I-5 Collisions – Center Drive to Gravelly Lake Drive – 2010 to 2014

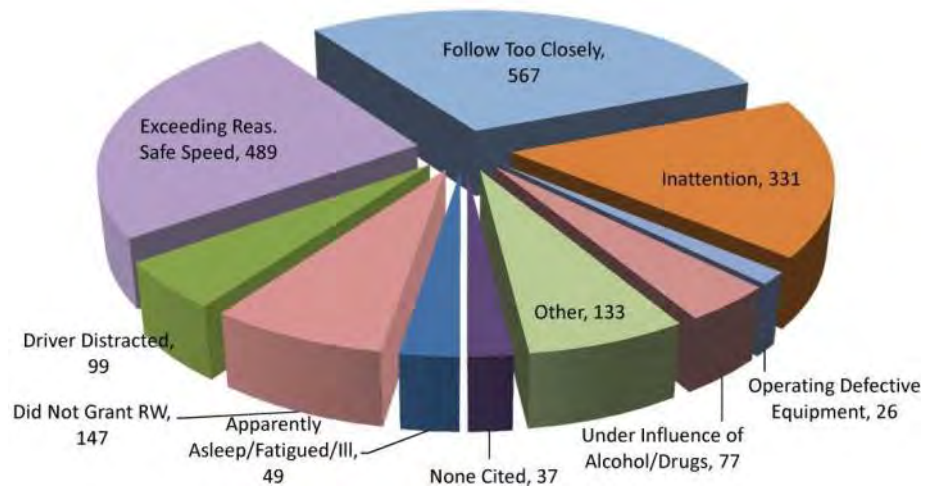

9.4 Effect of Collision on the Traffic Flow and Speeds along I-5

Figure 56 illustrates the effect of a collision on traffic congestion along I-5 through the study area. Data were obtained for a specific incident that occurred at approximately 2 PM on February 28, 2013 in the southbound directions of I-5. Traffic did not clear and begin to move until 4 PM. Northbound traffic remained slow until 7 PM and southbound traffic did not resume normal speeds until after 8 PM.

Figure 56: Speeds on I-5 between Exits 114 and 127 with a 2 PM Crash

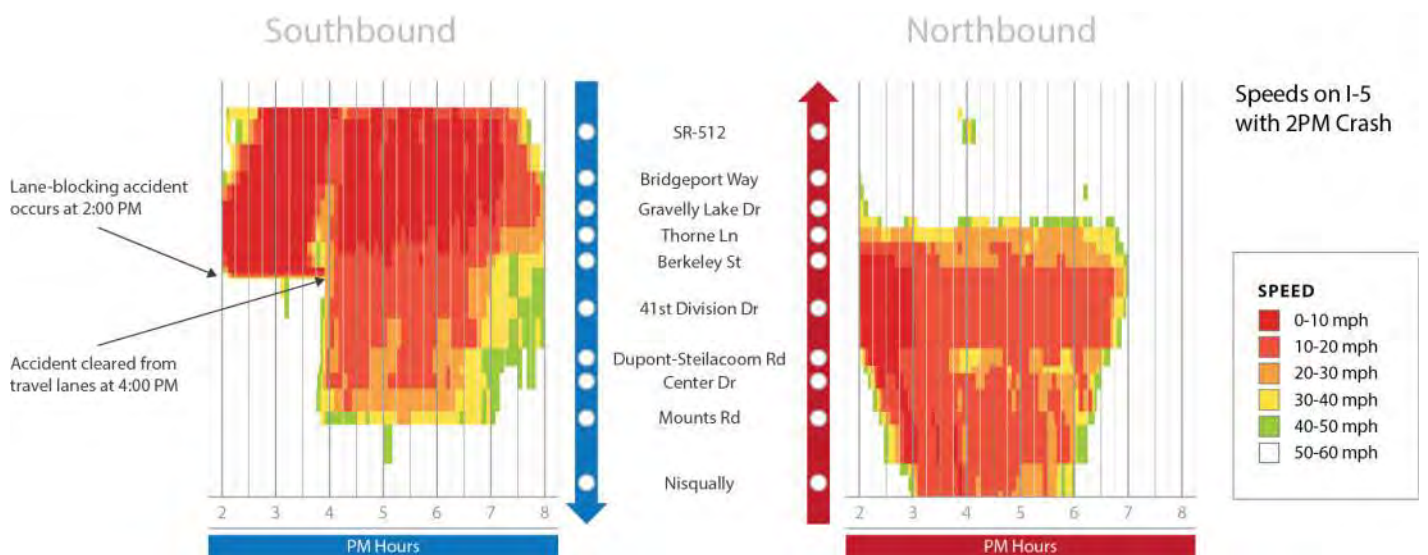

9.5 Effect of Proposed Build Alternative on I-5 Collisions

The Build Alternative is expected to improve operations in the opening year of operation, add capacity, reduce congestion, and reduce mainline collisions. In addition, the reconfigured interchanges with roundabouts and longer ramps at Berkeley Street and Thorne Lane are expected to reduce collisions at the ramp terminals by reducing the number of conflict points as compared to signalized intersections. Also, the ramps are designed with longer queue areas that would reduce queue backing up onto the I-5 mainline, resulting in less traffic flow interruptions along I-5 and reduced collisions. By the 2040 design year, congestion would once again become a dominant pattern and other improvements would be needed to reduce collisions.

To quantitatively assess the expected effect of the Build Alternative on safety a future year collision analysis was conducted using the *Enhanced Interchange Safety Analysis Tool (ISATe)* developed for the National Cooperative Highway Research Program. This model estimates future year collisions based on projected traffic volumes and the geometric design of the proposed interstate and interchanges for the No Build and Build Alternatives. A summary of the ISATe model results is located in Appendix G.

For the No Build Alternative, with future year traffic demand and increased congestion without any major capacity improvements, the number of collisions along I-5 is expected to increase between 2013 and 2020 and beyond to 2040. For the Build Alternative with improved interchanges and added capacity, collisions along I-5 and at the interchanges in 2020 and 2040 are expected to be higher than the No Build Alternative because of higher expected traffic levels along the I-5 corridor, as shown in Table 12. However, the overall collision rate per million vehicles is slightly lower for the Build Alternative than for the No Build Alternative.

Table 12: Comparison of 2020 and 2040 Predicted Collisions on I-5 – Center Drive Interchange to Gravelly Lake Drive Interchange

Alternative	Mainline Collisions		Ramp Collisions		Ramp Intersection Collisions		Total Collisions	Total Collisions per MVM
	Number	Per MVM	Number	Per MVM	Number	Per MEV		
2020 No Build	354	0.87	27	1.13	40	0.42	421	1.08
2020 Build	377	0.91	30	1.18	42	0.42	449	1.06
2040 No Build	443	0.96	25	1.05	45	0.43	513	1.14
2040 Build	491	0.97	36	1.42	42	0.41	569	1.11

Notes:

MVM = Million vehicle miles

MEV = Million entering vehicles

Based on average traffic volumes at the permanent count location south of the Main Gate Interchange

10.0 Effects of the Build Alternative on Local Streets and Intersections

The redesign and relocation of the interchanges at Thorne Lane and Berkeley Street would affect local travel patterns and change how drivers access I-5 from the local street system. Traffic on local roads would also be affected by the amount of congestion on I-5. As congestion increases on I-5, either northbound or southbound, more traffic is expected to shift to local roads. In addition, some drivers may use alternate interchanges to reach their final destination, depending on the level of congestion on I-5. Traffic changes caused by the reconfiguration of the Thorne Lane and Berkeley Street interchanges, the addition of I-5 travel and auxiliary lanes, and the Gravelly-Thorne Connector are discussed below.

Thorne Lane: At Thorne Lane, the existing bridge over I-5 is proposed to be removed and replaced with a new bridge about 350 feet to the south that would grade-separate Thorne Lane over I-5, the adjacent rail line and Union Avenue, as previously shown in Figure 30. The new bridge would change part of the Thorne Lane and Murray Road alignment to connect to the existing street system. In addition, a new loop connector road would be added to tie Union Avenue to Thorne Lane. The proposed southbound Gravelly-Thorne Connector and the new northbound auxiliary lane between the Thorne Lane and Gravelly Lake Drive interchanges would also affect traffic movements to and from the Tillicum and Woodbrook neighborhoods. The new interchange is proposed to have roundabouts at the I-5 ramp intersections instead of traffic signals.

These interchange revisions, together with the new southbound only Gravelly-Thorne Connector roadway and northbound auxiliary lane between Thorne Lane and Gravelly Lake Drive, would likely affect local travel patterns in the vicinity of the Thorne Lane interchange. Because of the Gravelly-Thorne Connector, some trips would be diverted from I-5 and would use the new roadway connected to Union Avenue near Thorne Lane. This diversion is an intended benefit of the proposed Build Alternative.

Changes in two-way traffic volumes on local roads near the Thorne Lane interchange are shown in Table 13 for the No Build and Build Alternatives. With the No Build Alternative, two-way traffic along Union Avenue near Thorne Lane in 2020 and 2040 is expected to be approximately 355 vehicles during the AM peak hour, and around 525 vehicles during the PM peak hour. With the Build Alternative, AM peak hour two-way volume on Union Avenue is expected to be less than 205 vehicles in 2020 and 2040, and the PM peak hour volume would be about 290 vehicles in 2020, but reduced to about 185 vehicles by 2040. In general, volumes on Union Avenue are expected to be lower with the Build Alternative as a result of the added capacity on I-5 and the improved interchanges.

Table 13: 2020 and 2040 AM and PM Peak Hour Two-way Volumes on Local Streets near the Thorne Lane Interchange – No Build Alternative vs. Build Alternative

Location	No Build Alternative				Build Alternative			
	2020 AM	2020 PM	2040 AM	2040 PM	2020 AM	2020 PM	2040 AM	2040 PM
Union Avenue south of Thorne Lane	355	525	390	385	205	290	180	185
Thorne Lane west of Union Avenue or Union Avenue Loop Connector	375	570	440	455	590	1,180	705	885
Thorne Lane over I-5	1,020	1,115	1,165	1,095	1,125	1,645	1,405	1,540

On Thorne Lane west of Union Avenue, compared to the No Build Alternative traffic is expected to increase with the Build Alternative during the AM peak hour by about 215 vehicles in 2020 and by about 265 vehicles in 2040. It is expected to increase during the PM peak hour by about 610 vehicles in 2020 and by about 430 vehicles in 2040. On the bridge over I-5, 2020 Build Alternative traffic would increase by about 100 (in the AM peak hour) to 530 (in the PM peak hour) vehicle trips in comparison to the No Build Alternative, but by only between 240 (in the AM peak hour) to 445 (in the PM peak hour) vehicles in 2040. Based on the predicted level of traffic, the current and newly constructed roadways serving the Thorne Lane interchange would have adequate carrying capacity and are not expected to be impacted by the slight changes in vehicle traffic.

Berkeley Street: At Berkeley Street, the existing bridge over I-5 is proposed to be removed and replaced with a new bridge centerline about 120 feet south of the existing bridge centerline. The new interchange would have roundabouts at the I-5 ramp intersections. The new bridge would extend Jackson Avenue over I-5, the adjacent rail line and Militia Drive. The Jackson Avenue extension would tie into Berkeley Street just west of Washington Avenue, as previously shown in Figure 30. The segment of Berkeley Street east of Union Avenue, including the at-grade railroad crossing near I-5, would be removed. A new residential street would be added and connected to Grant Avenue to provide access for properties along a southern portion of Washington Avenue.

Changes in two-way traffic volumes on local roads near the Berkeley Street interchange are shown in Table 14 for the No Build and Build Alternatives. Two-way traffic along Berkeley Street west of Washington Avenue in 2020 and 2040 is expected to be less than 525 vehicles during the AM and PM peak hours for the No Build and Build Alternatives.

For the portion of Berkeley Street between Union Avenue and Washington Avenue, traffic is generally expected to be reduced with the Build Alternative, as traffic to and from Camp Murray would use the new interchange and the new extension to Jackson Avenue, and would connect to Berkeley Street north of Washington Avenue. However, because of increased

congestion along southbound I-5 during the 2040 PM peak hour, some I-5 southbound drivers would likely exit at Thorne Lane, and use Union Avenue and Berkeley Street to reach their destinations. Traffic along Washington Avenue is expected to be about the same under the No Build Alternative in both 2020 and 2040, and to be less than 140 vehicles.

Table 14: 2020 and 2040 PM Peak Hour Two-way Volumes on Local Streets near the Berkeley Street Interchange – No Build Alternative vs. Build Alternative

Location	No Build Alternative				Build Alternative			
	2020		2040		2020		2040	
	AM	PM	AM	PM	AM	PM	AM	PM
Berkeley Street west of Washington Avenue	415	510	525	450	415	365	445	380
Berkeley Street between Union Avenue and Washington Avenue	460	545	575	515	375	300	385	250
Berkeley Street Bridge over I-5	1,475	1,190	1,370	1,280	1,590	1,570	1,675	1,255
Washington Avenue north of Berkeley Street	55	75	70	85	50	75	70	140
Union Avenue north of Berkeley Street	380	365	395	500	365	295	375	300

Traffic volumes crossing I-5 on the new bridge are generally expected to increase with the capacity added by the Build Alternative. An exception would be during the PM peak hour in 2040, when a decrease of about 100 vehicles is expected. Based on the operations analyses of the intersections along these local roads with the Build Alternative, traffic is expected to operate at LOS C or better during both the AM and PM peak hours in 2020 and 2040.

The change in travel patterns would be isolated to a small area of the Tillicum neighborhood, and the subsequent change would not impact or create any adverse conditions on the local roadways. The revised intersection at Berkeley Street/Washington Avenue can be designed to discourage cut-through traffic on Washington Avenue. Possible mitigations can include right-in/right-out operations at the intersection and traffic calming features on Washington Avenue north of Berkeley. The final intersection layout would be designed to discourage both commuter and commercial traffic from using Washington Avenue as a cut-through route to reach destinations beyond the nearby neighborhoods.

Gravelly-Thorne Connector: A new southbound connector road, referred to as the Gravelly-Thorne Connector, is proposed to be constructed to provide a non-freeway connection between Lakewood and the neighborhoods of Tillicum and Woodbrook. Traffic along this new southbound connector road is expected to range from about 25 vehicles (in 2020 AM peak hour) to 75 vehicles (in 2020 PM peak hour). In 2040, traffic along this new southbound connector road is expected to be about 40 vehicles in the AM peak hour and 240 vehicles in

the PM peak hour. Drivers are expected to use this new connector, instead of I-5 or other roads within the secure military installations, to travel from Lakewood to the Tillicum and Woodbrook neighborhoods, Camp Murray, and JBLM. These diversions would be an intended benefit of the proposed Build Alternative. In addition, a new northbound auxiliary lane between the Thorne Lane and Gravelly Lake Drive interchanges would be added, as previously illustrated in Figure 31. This connection offers additional I-5 capacity to accommodate northbound traffic movement between these two interchanges to complement the southbound capacity added by the Gravelly-Thorne Connector.

11.0 Transit Service and TDM Activities within the I-5 Study Area

Transit and vanpool service are important factors that affect traffic operations along I-5. The following is a summary of the existing transit service along the I-5 corridor through the JBLM area and the benefits to traffic operations.

11.1 Existing Transit Service along I-5

Currently, there are three public transit providers operating within the study area: Intercity Transit, Pierce Transit, and Sound Transit. An illustration of existing transit routes, transit centers and park-and-ride lots within the study area is presented in Figure 57.

Intercity Transit: Based in Thurston County, Intercity Transit (IT) operates five routes through the study area, and sub-contracts service for a sixth route. All routes provide access to JBLM through a transfer at the Lakewood Transit Station to



Pierce Transit buses, but none operate directly on the base due to strict security regulations prohibiting general public riders from entering the facility. IT service through the study area includes:

- Route 603 is a weekday route providing bi-directional service between downtown Olympia/Capitol Campus, Lacey (Martin Way park and ride), Lakewood (Lakewood Station/SR 512 park and ride), and Tacoma (Tacoma Dome and downtown).
- Route 605 is a weekday route providing bi-directional service between downtown Olympia/Capitol Campus, Lacey (Martin Way park and ride), Lakewood (Lakewood Station/SR 512 park and ride), and Tacoma (Tacoma Dome and downtown).
- Route 609 is a weekday route providing bi-directional service between Tumwater (state agency campus), Olympia Capitol Campus, Lacey (Hawkes Prairie park and ride), and Lakewood (Lakewood Station/SR 512 park and ride).

Figure 57: Existing Transit Service and Park and Ride Lots

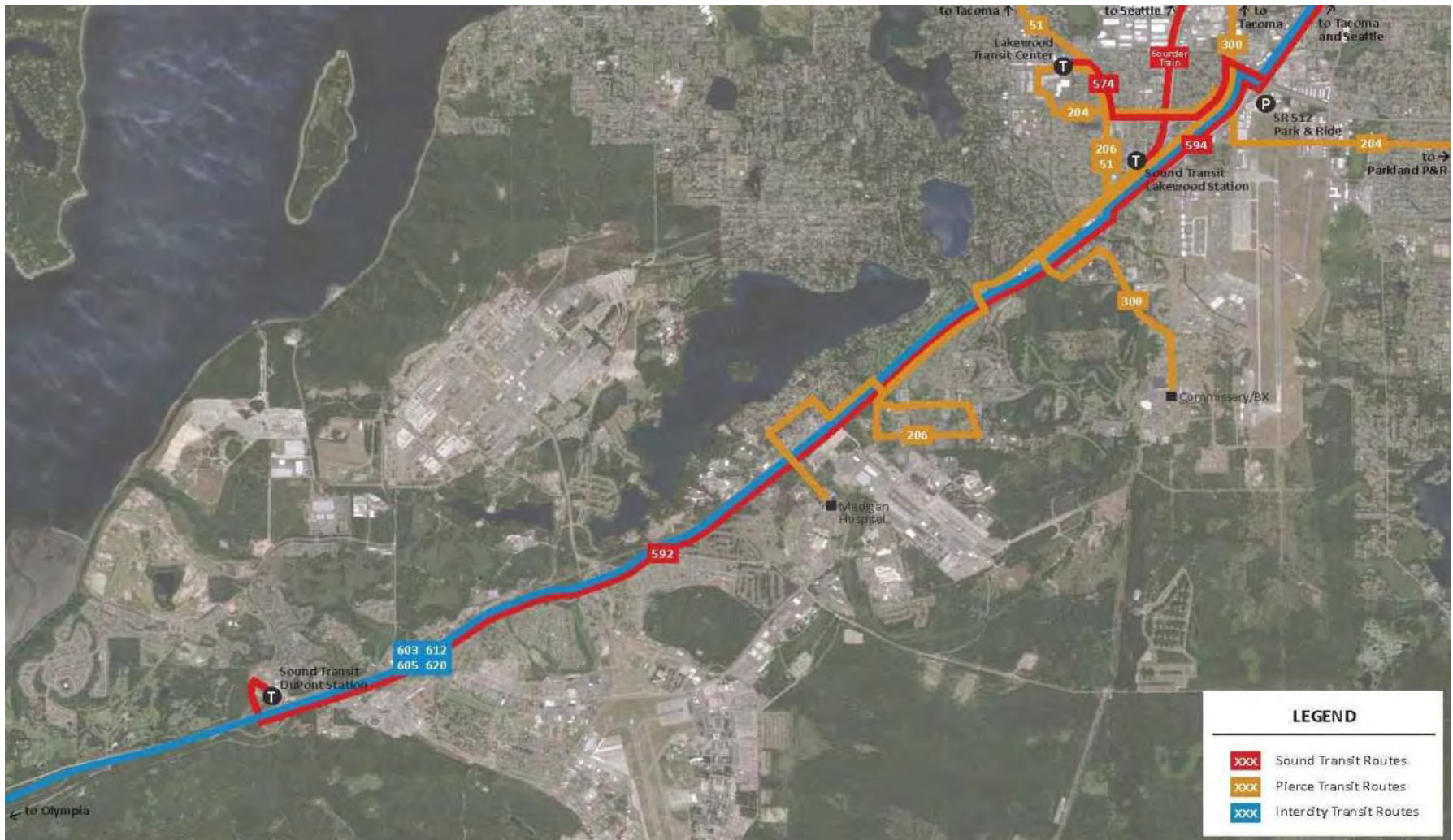

- Route 612 is a weekday route providing bi-directional service between Tacoma (Tacoma Dome and downtown), Lakewood (SR 512 Park and Ride and Lakewood Station), Lacey (Lacey Transit Center), and Olympia (Capitol Campus and downtown).
- Route 620 serves the study area on weekends providing bi-directional service between Olympia (downtown and Capitol Campus), Lacey (Lacey Transit Center and Martin park and ride), Lakewood (Lakewood Station and SR 512 park and ride lot), and Tacoma Mall.

IT contracts with Sound Transit to provide Route 592 weekday service between Olympia and Seattle which is described below under Sound Transit.

IT also offers a commuter vanpool program that serves a wide variety of destinations throughout Thurston, Pierce, Kitsap, Grays Harbor, King, and Lewis counties. Thirty-seven of the more than 230 IT vans currently on the road operate to and from JBLM (including Ft. Lewis, Madigan and McChord) and Camp Murray.

Additional vanpool groups use I-5 with destinations in the cities of Lakewood and DuPont. IT has been in regional discussions with JBLM to consider methods that would serve the general public's need for transit to the bases while satisfying the military's need for base security.

Pierce Transit: Pierce Transit is responsible for local bus service in Pierce County and operates four routes that provide access to or close to JBLM.



- Route 51 connects the Lakewood Station in the vicinity of the Bridgeport Way interchange with the Lakewood Transit Center and destinations in central and north Tacoma.
- Route 204 operates via South 112th Street and serves the SR 512 park and ride lot. Service is also available to McChord North Gate at the intersection of South 112th and Tacoma Way/Union Avenue.
- Route 206 operates between the Lakewood Transit Center and Madigan Hospital.
- Route 300 serves JBLM McChord Field operating between the Tacoma Mall Transit Center and McChord Commissary with stops at the SR 512 park and ride lot.

Similar to IT, Pierce Transit also offers regional vanpool services along the I-5 corridor. Currently 31 vans serve JBLM.

Sound Transit: The Central Puget Sound transit provider, Sound Transit (ST), operates three express bus routes along the I-5 corridor within the study area. All service is provided during peak periods in the morning and evening. ST does not provide local bus service to JBLM. The closest stops are located at the Lakewood Sounder Station and park and ride lot and in DuPont. The Sound Transit routes are:



- Route 574 operates between the Lakewood Transit Center and SeaTac Airport.
- Route 592 (Olympia Express) operates between the Olympia Transit Center and downtown Seattle including the Hawks Prairie park and ride lot, DuPont, Lakewood and the SR 512 park and ride. Since October 2013, service has been contracted by IT and operated by ST.
- Route 594 operates between the Lakewood Sounder Station and Seattle.

ST also operates Sounder Rail Service that connects Seattle and Tacoma with the Lakewood Sounder Station. Sounder service is operated in the former BNSF right of way adjacent to and west of I-5 that is now owned by ST. As part of the *Point Defiance Bypass Project*, WSDOT will eventually improve the tracks along this corridor for Amtrak Cascades and Coast Starlight services which is expected to relocate from the current Point Defiance route in 2017. ST's Long-Range Plan includes the potential for commuter rail service to operate to DuPont (and possibly beyond), as well as to JBLM. Such service would likely require adding a second track within the right of way, grade-separating certain crossings, and locating new station(s) by the gate(s) to/from JBLM. Options for expanding I-5 and reconfiguring the interchanges should anticipate these rail operations and facilities, and not preclude or adversely impact them.

11.2 Park and Ride Lots

There are seven primary park and ride lots within or serving the corridor study area. A summary of the park and ride inventory data, including number of parking stalls and utilization is shown in Table 15.

Table 15: Park and Ride Lot Inventory

Facility/Lot	City	Location	Number of Parking Spaces	Average Daily Utilization
SR 512	Lakewood	I-5 & SR 512	493	93%
Lakewood Sounder Station	Lakewood	Pacific Highway & 47 th Avenue SW	600	50%
DuPont	DuPont	Wilmington Drive & Palisade Blvd	126	63%
Martin Way	Lacey	I-5 & Martin Way	318	65%
Hawks Prairie	Lacey	I-5 & Hogum Bay Road	332	27%
Centennial Station	Thurston Co.	6600 Yelm Hwy SE	110	2%
Tumwater	Tumwater	Israel/Bonniewood Rd SE	30	15%

Source: Intercity Transit, Pierce Transit and Sound Transit, 2013.

10.3 Commute Trip Reduction

In 1991, the Washington State Legislature adopted the Commute Trip Reduction (CTR) Law as a tool to help address the growing traffic congestion problem in the state. The CTR encourages the use of non-single occupant vehicle travel modes for works trip using employer-based programs. In 2006, legislators passed the CTR Efficiency Act, that requires local governments in urban areas with traffic congestion to develop programs to reduce drive-alone trips and vehicle miles traveled per capita.

By 2009, the CTR Program had removed 30,000 vehicles from the states roadways each morning, reducing congestion, air pollution and energy consumption. Traffic delays have been cut by eight percent in the Central Puget Sound region, and rush hour commuters saved about \$59 each during that year in fuel and time. CTR participants also conserved about 3 million gallons of gasoline in the 2009-2010 biennium and drove 154 million fewer miles in comparison with 2007. (Data from WSDOT's CTR website, December 23, 2013.)

CTR targets workplaces with 100 or more full-time employees in the most congested areas of the state. Employers develop and manage their own programs based on locally-adopted goals for reducing vehicle trips and miles traveled. Statewide there are more than 1,050 worksites and 530,000 commuters participating in the CTR program. Employers regularly report on their programs and jurisdictions report on progress toward meeting drive-alone and Vehicle Miles Travelled (VMT) reduction targets.

As noted previously, within the I-5 JBLM study area there are several active CTR programs that affect travel along I-5. These programs are provided by IT and Pierce Transit, which offer carpool, vanpool and other TDM services. In addition to the vanpool service provided by IT and Pierce Transit, Seattle Metro and JBLM also provide vanpool services that reduce traffic flow along the I-5 corridor.

As the largest employer in Pierce County, JBLM has developed an active CTR program:

- Approximately 125 employees use bus subsidies
- Approximately 375 employees use vanpools from either Pierce Transit or Intercity Transit

(Based on data from *Joint Base Lewis-McChord Growth Coordination Plan*, The Transpo Group, 2010)

The Department of the Army has a program called the "Mass Transportation Benefit Program" (MTBP) that provides reimbursement for using mass transit (either vanpool or carpool). The MTBP is available to all personnel on base (civilian and military) and is a non-taxable program that subsidizes the use of transit up to \$245 per month.

11.4 Transit Performance

As previously shown in Figure 57, there are twelve existing transit routes that serve the study area, either directly or by accommodating through trips that may otherwise have been made in a single occupant vehicle. Even more significant in terms of reducing demand on I-5 is the level of vanpool activity presently occurring within the study area. The following is an analysis of transit ridership and vanpool activity as it affects I-5 in the study area. The focus of this analysis is the PM peak period, which typically has the highest level of congestion of any time period within the corridor.



Transit Ridership on I-5 in the Study Area: Table 16 presents a summary of existing PM peak period (3-6 PM) transit ridership on I-5 in the study area as of November 2013. Currently bus transit service in the area is provided primarily by three agencies: Intercity Transit (serving Olympia and Thurston County), Pierce Transit (serving Tacoma and Pierce County), and Sound Transit (serving the Central Puget Sound region). An additional three trips during this time period are provided by the Bremerton-Kitsap Airporter which directly services JBLM, connecting it with the Sea-Tac Airport.

As indicated in the table, IT is currently providing seventeen bus trips through the study area during the 3:00 PM to 6:00 PM peak period, ten in the northbound direction and seven in the southbound direction. The ten northbound routes carry a total average weekday ridership of 214 persons during the PM peak period. The seven southbound routes carry a total average weekday ridership during the PM peak period of 101 persons. This equates to a total weekday PM peak period average of 315 persons.

Pierce Transit has twenty-two buses serving the study area during the PM peak period, eleven in the northbound direction and eleven southbound. Average total weekday ridership during this time period is 226 persons northbound and 299 southbound for a total of 525 persons.

ST has eight trips serving the study area during this same time period, all of which head southbound. Average weekday PM peak period ridership is 232 persons.

Table 16: Weekday PM Peak Period (3-6 PM) Transit Ridership in the Study Area

Agency	Route	Number of Buses		Ridership	
		NB	SB	NB	SB
Intercity Transit	Route 603	5		159	
	Route 605		3		79
	Route 609	4	4	27	22
	Route 612	1		28	
Pierce Transit	Route 206	5	5	100	160
	Route 300	6	6	126	139
Sound Transit	Route 592		8		232
Totals		21	26	440	632

Source: Intercity and Pierce Transit, 2013.

The total number of buses providing service on I-5 in the study areas during a typical weekday PM peak period is twenty-one northbound and twenty-six southbound. Total persons using transit in the I-5 corridor during this same time period is 440 northbound and 632 southbound for a total weekday PM peak period ridership of 1,072 persons.

Vanpool Ridership on I-5 in Study Area: Table 17 shows weekday PM peak hour ridership in existing vanpools during the summer of 2013. Only official vanpools sponsored by one of the transit operators providing service in the study area are included in this table. Additional vanpool service is provided by other transit agencies and private employers. Currently, IT sponsors 71 vanpools that serve the study area during the PM peak hour. Twenty-two of these vanpools are traveling in the northbound direction from Thurston County to destinations in Pierce and King Counties. These vanpools carry an average of 205 persons on I-5 during the PM peak hour. Forty-nine of these vanpools are traveling southbound from a variety of destinations to Thurston County. These IT vanpools carry an average of 367 persons on I-5 during the PM peak hour.

Pierce Transit sponsors 16 northbound and 3 southbound vanpools that use I-5 through the study area during the weekday PM peak hour. Vanpool ridership on I-5 during this time period is 128 northbound and 24 southbound for a total of 153 persons.



Table 17: Weekday PM Peak Hour (4-5 PM) Vanpool Ridership in Study Area

Agency	Begin Trip	End Trip	Number of Vanpools		Ridership	
			NB	SB	NB	SB
Intercity Transit	King County	Thurston County		6		41
	Thurston County	King County	8		88	
	Kitsap County	Thurston County		2		19
	Camp Murray	Thurston County		3		19
	DuPont	Thurston County		12		76
	Gig Harbor	Thurston County		1		18
	JBLM/Ft. Lewis	Thurston County		10		70
	JBLM/Madigan	Thurston County		9		79
	Tacoma	Thurston County		6		45
	Thurston County	Pierce County	14		117	
Pierce Transit ⁽¹⁾	Pierce County	JBLM	16	3	129	24
Totals			38	52	334	391

⁽¹⁾ Only partial ridership data is available, ridership total based on estimated average vanpool ridership.

Impacts of I-5 Congestion on Transit: Existing transit service along I-5 in the study area primarily serves either regional through trips, trips to/from ST’s Lakewood Station, or trips to/from the Lakewood Transit Center. With over 62,000 employees, JBLM is the second largest employer in Washington State and is the largest potential transit destination in the study area. However, the secure nature of JBLM limits the effectiveness of regular fixed route transit because buses carrying non-military personnel cannot enter the secure facility or require non-military riders to deboard at the security gate. Currently only two routes serve the base, one to Madigan Hospital and the other to the McChord Commissary.

Unlike fixed route bus service, vanpools and carpools that carry only base personnel do have access to and from JBLM. There are vanpools sponsored by the major transit providers in the area that are currently connecting JBLM with destinations throughout the region. In 2013, vanpools and bus service carried approximately 1,200 people along I-5 during the PM peak hour.

Both transit service and vanpools are impacted by freeway congestion, with existing PM peak travel times exceeding off-peak travel time by 75 percent. With no HOV facilities within the study area to facilitate the advantages of alternative mode choices, buses and vanpools are caught in the same traffic as single-occupant vehicles.

With the proposed Build Alternative, all traffic, including transit, carpools, and vanpools, would have shorter travel time in 2020 as compared to the 2020 No Build Alternative. Travel time savings of 10 to 20 minutes for southbound travelers and 10 to 30 minutes for northbound

travelers for trips between SR 510 and SR 512 along I-5. This allows for better transit reliability through the JBLM area along I-5.

Transit and Vanpooling Benefits to Traffic Operations along I-5: Existing transit and vanpool ridership on I-5 in the study area has a substantial impact on reducing vehicular congestion in the corridor during peak weekday travel periods. As illustrated in Table 18, if existing riders were to switch to individual vehicles, a total of approximately 1,000 vehicles would be added to existing I-5 PM peak hour traffic (approximately 440 northbound and 560 southbound).

Table 18: Benefits of Transit and Vanpooling – Weekdays during 4 to 5 PM Peak Hour

Agency	Mode	Ridership		Number of Cars Taken off I-5	
		NB	SB	NB	SB
Intercity Transit	Bus	89	83	73	68
	Vanpool	205	367	168	301
Pierce Transit	Bus	100	96	82	79
	Vanpool	129	24	106	20
Sound Transit	Bus	11	107	9	88
Totals		534	677	438	555

By way of comparison, 560 vehicles represent about 31 percent of the existing maximum per lane capacity in the congested heart of the corridor. Thus, it is reasonable to conclude that the availability of transit and vanpooling options significantly benefits existing highway traffic operations. By making transit more reliable, the proposed Build Alternative can encourage more drivers to switch from single occupancy vehicles to transit buses and vanpools to commute to and from their workplace.

11.5 Effect of the Build Alternative on Transit and Transportation Demand Management (TDM) Activities

While changes to the existing level of transit service are not included as part of the proposed Build Alternative, the added general purpose lanes along the I-5 mainline would benefit the operations, speed and reliability of transit and various TDM activities such as vanpooling and ridesharing.

With added travel lanes in the Build Alternative from the Thorne Lane to Steilacoom-DuPont Road interchanges, transit travel times would be improved along with all travel modes in comparison to the No Build Alternative. Speeds would be more stable along I-5 and interchange operations would be improved. With the proposed Build Alternative, transit, carpools, and vanpools, as well as general traffic are expected to have shorter PM peak period travel times in 2020, as compared to the No Build Alternative. Travel time savings would be in the order of four minutes for southbound travelers through the JBLM area. Northbound

travelers could expect about 13 minutes in travel time savings for trips between Center Drive and Gravelly Lake Drive. These shorter travel times allow for better transit reliability and schedule adherence along I-5 through the JBLM area, and would also encourage additional vanpool and carpool activities.

In 2040, northbound travel times along I-5 through the project area would improve with the addition of the near-term facilities included with the proposed Build Alternative, while southbound travel time would increase. As a result, transit service, as well as all traffic, would be affected equally.

12.0 Build Alternative Benefits to Bicycle and Pedestrian Travel in the Study Area

The proposed Build Alternative includes a separate shared-use path for bicyclists and pedestrians along I-5 from Steilacoom-DuPont Road to Berkeley Street. In addition, bicycle and pedestrian facilities are included along the Gravelly-Thorne Connector. Bicyclists and pedestrians would be able to travel between DuPont and Lakewood by using local streets from Center Drive to Steilacoom-DuPont Road. They could travel on the new shared-use path to the Tillicum neighborhood, on local streets through Tillicum, and along the Gravelly-Thorne Connector to Lakewood, as previously shown on Figure 32.

The redesigned interchanges at Berkeley Street and Thorne Lane are proposed to have pedestrian and bicycle lanes, with sidewalks or shared-use areas to improve non-motorized access over I-5 and the adjacent rail line, connecting portions of Lakewood with JBLM. The improved connections would allow persons stationed or working at JBLM, but living in adjacent communities, the opportunity to walk or bicycle to their duty station or work activities.

13.0 Construction Traffic Effects of the Build Alternative

13.1 Closures on I-5 and/or its Existing Interchanges

The redesigned interchanges at Berkeley Street and Thorne Lane would be shifted south of the existing interchanges, which would result in fewer impacts to traffic operations during construction than would reconstruction at existing locations. However, some long-term temporary closures (three to six months) may be needed to rebuild the southbound on- and off-ramps at both interchanges. The current intention is to close the southbound ramps at one interchange at a time, while continuing to provide access to local neighborhoods, Camp Murray, and JBLM via the adjacent interchange. The southbound ramp long-term temporary closures could have the following effects:

- Some drivers are expected to use adjacent interchanges such as Berkeley Street when Thorne Lane is closed or Thorne Lane when Berkeley Street is closed.

-
- Some drivers may use local streets during these closures.
 - Some drivers may change the timing of their trips to avoid peak travel times.

A preliminary analysis was conducted to identify potential impacts associated with the long-term temporary closure of the southbound ramps at the Thorne Lane and Berkeley Street interchanges. Analysis showed that, while some traffic on local streets would be changed, the resulting volumes are well within the capacity that these roadways are designed to accommodate.

Temporary northbound on- and off-ramps would be provided around the interchange construction sites to maintain access to neighborhoods and the military installations. However, nighttime and/or weekend closures may be needed while the new ramps are being connected to the existing street system and to I-5.

Construction plans would be developed to keep three lanes open in both the northbound and southbound direction on I-5 between Thorne Lane and Center Drive during daytime and peak travel hours. I-5 will be narrowed and shifted through the corridor construction zone. In addition, nighttime lane closures would be needed to widen I-5, and to build walls and bridge abutments.

13.2 Local Street Closures during Construction

With the Berkeley Street and Thorne Lane interchanges being constructed away from the existing structures, temporary closures of local streets are not expected. However, some short-term lane closures or detours would likely be needed to connect the proposed improvements with the existing street system.

13.3 Effects of Construction on Existing Transit Service and Bus Routing

Pierce Transit route #206 serves the Tillicum and Woodbrook communities as well as Madigan Hospital on JBLM. This route will need to pass through the construction work zones for the Thorne Lane and Berkeley Street interchanges, as well as the I-5 mainline between Gravelly Lake Drive and Berkeley Street. During the temporary closures of southbound ramps at the Thorne Lane and Berkeley Street interchanges, the path of Route 206 will need to be modified. Additionally, all transit service provided by Intercity Transit, Pierce Transit and Sound Transit along the I-5 mainline will need to pass through the construction work zone and may be affected by construction-related activity.

School bus service is currently provided by the Clover Park School District to the Tillicum Elementary School and Woodbrook Middle School. This service would be impacted by construction activity at both the I-5/Thorne Lane and I-5/Berkeley Street interchanges.

13.4 Construction Traffic Haul Routes

With secure military installations on both sides of the project area, I-5 would be the primary route used to access the construction sites. SR 512 and SR 510 may also be used to haul construction materials to and from the construction area, depending on the location of material sources, off-site manufacturing areas, and staging areas used by the selected contractor.

13.5 Construction Traffic Mitigation

Prior to award of the first construction contract to build the improvements included in the Build Alternative, a Transportation Management Plan (TMP) will be developed. The TMP will define strategies to manage traffic through the project's construction work zones during each construction phase. Transit agencies, local governments, school districts, JBLM, Camp Murray and others as appropriate will be invited to participate in development of the TMP. The TMP will be monitored and amended over time as necessary.

Some suggested mitigation measures that could be implemented to manage construction traffic could include:

- Allowing the contractor to close only one ramp at a time.
- Providing advanced communications to all affected parties about closures including times and dates.
- Signing for detour routes to optimize routing and minimize impacts to residential streets and neighborhoods.
- Adjusted signal timings at adjacent interchanges to account for the added construction-detour traffic.

Appendix A
Methods & Assumptions Document

This Page Intentionally Left Blank



***I-5 Joint Base Lewis-McChord Vicinity
Interchange Justification Report &
Environmental Documentation***

**Methods & Assumptions
Document**

**Prepared for: Washington State Department of
Transportation**

Prepared by: H.W. Lochner, Inc. & Shea Carr Jewell, Inc.

In association with:

The Transpo Group, Inc.

Shannon & Wilson, Inc.

April 2013





Table of Contents

	Page
1. Stakeholder Acceptance	1
2. Introduction and Project Description	3
3. Analysis Years/Periods	6
4. Project Study Area	6
5. Traffic Operations Analysis	7
6. Travel Forecast.....	8
7. Highway Network Assumptions	8
8. Build Highway Network Assumptions.....	10
9. Safety Issues	10
10. Deviations/Justifications.....	10
11. Selection of Measures of Effectiveness (MOE)	10
12. Resolution of Late Comments.....	11
13. Conclusion.....	11

Figures

1. Project Study Area.....	11
----------------------------	----



Methods and Assumptions

1. Stakeholder Acceptance

“The undersigned parties, including all members of the team from WSDOT, FHWA and the Local Agencies, concur with the Interchange Justification Report Methods and Assumptions for the I-5 Joint Base Lewis-McChord Vicinity Interchange Justification Report (I-5 JBLM Vicinity IJR) as presented in this document.” The signature pages for each jurisdiction are attached at the back of this document.

STAKEHOLDER ACCEPTANCE

Joint Base Lewis-McChord

Signature

Title

Date

Camp Murray

Signature

Title

Date

City of Lakewood

Signature

Title

Date

City of DuPont

Signature

Title

Date

Town of Steilacoom

Signature

Title

Date

Pierce County

Signature

Title

Date

SEE ATTACHED AGENCY
SIGNATURE PAGES

- (1) Participation on the Stakeholders Committee and/or signing of this document does not constitute approval of the I-5 JBLM Vicinity IJR.
- (2) All members of the Stakeholder Committee will accept this document as a guide and reference as the study progresses through the various stages of project development. If there are any agreed upon changes to the assumptions in this document a revision will be created, endorsed and signed by all the stakeholders.



Thurston Regional Planning Council

Signature

Title

Date

Puget Sound Regional Council

Signature

Title

Date

WSDOT – Olympic Region

Signature

Title

Date

WSDOT – Olympic Region Traffic Office

Signature

Title

Date

WSDOT – HQ Traffic Office

Signature

Title

Date

WSDOT – HQ Development Division

Signature

Title

Date

WSDOT – HQ Access and Hearings

Signature

Title

Date

FHWA

Signature

Title

Date

SEE ATTACHED AGENCY
SIGNATURE PAGES

(1) Participation on the Stakeholders Committee and/or signing of this document does not constitute approval of the I-5 JBLM Vicinity IJR.

(2) All members of the Stakeholder Committee will accept this document as a guide and reference as the study progresses through the various stages of project development. If there are any agreed upon changes to the assumptions in this document a revision will be created, endorsed and signed by all the stakeholders.



2. Introduction and Project Description

Interstate 5 (I-5) is a national highway of strategic importance as it travels from the US/Mexican Border to the US/Canadian border. It is the primary highway for the movement of goods and people traveling north and south on the west coast of the United States. In Washington, I-5 links key population centers Vancouver, Olympia, Tacoma, Seattle, Everett and Bellingham.

Over the past several years, traffic has increased along the entire I-5 corridor from Mexico to Canada. Within our study area in south Pierce County, traffic has also grown, as Joint Base Lewis-McChord (JBLM) has evolved into a strategic military base, Camp Murray has expanded, and the communities of Lakewood, DuPont and Steilacoom have grown. These area changes have added to the increased through-traffic along the I-5 corridor from Olympia to Seattle. Because of the presence of secured military bases on both sides of I-5, there are no routes to use without extended detours to bypass the military bases. Congestion along I-5 through the JBLM vicinity has become a daily occurrence with ramp traffic backing onto the I-5 mainline causing delays and safety issues.

The I-5 JBLM Vicinity IJR Project will include:

- Development of an I-5 Interstate Corridor Plan from the I-5/Center Drive Interchange to the I-5/Gravelly Lake Road Interchange;
- Development of a corridor-wide Interchange Justification Report for revisions to the I-5/Steilacoom-DuPont Road Interchange, I-5/Main Gate Interchange, I-5/Berkeley Street Interchange, and I-5/Thorne Lane Interchange;
- Prioritization of interstate improvements; and
- Preparation of the Environmental Documentation and associated preliminary engineering for highest priority improvements.

Purpose of the Project

The purpose of this project is to define improvements to relieve traffic congestion on the I-5 corridor in the JBLM vicinity with a focus on M.P. 119 to 124 including the interchanges with Steilacoom-DuPont Road, Main Gate, Berkeley Street, and Thorne Lane. A corridor Interchange Justification Report will be prepared addressing these four interchanges at a minimum. The IJR document will be developed in cooperation with the Federal Highway Administration (FHWA), WSDOT, JBLM, Camp Murray, Puget Sound Regional Council (PSRC), Thurston Regional Planning Council (TRPC), Pierce County, Intercity Transit, Pierce Transit, the Town of Steilacoom, and the cities of Lakewood, DuPont, and Lacey.

This project will then develop the necessary environmental documentation and preliminary engineering for the highest priority element(s) of the preferred solutions, as guided by the stakeholders.

The results of the Interchange Justification Report (IJR) and environmental documentation will enable the project stakeholders to assess options and opportunities to improve the transportation system within the study area, and solicit funds to implement the preferred solution in a logical manner. Specifically, the project will address:



- Relieving congestion on I-5 within the study area;
- Improving local and mainline system efficiency;
- Enhancing mobility;
- Improving safety and operations;
- Increasing transit and TDM opportunities.

Project Leads and Proponents

- Washington State Department of Transportation
- Federal Highway Administration
- Joint Base Lewis-McCord
- Camp Murray
- City of Lakewood
- City of DuPont
- Town of Steilacoom
- City of Lacey
- Pierce County
- Puget Sound Regional Council
- Thurston Regional Planning Council
- Intercity Transit
- Pierce Transit

Environmental Document Type

Depending on the selected project(s) and the degree of impacts, we are envisioning a Documented Environmental Classification Summary (DECS) or an Environmental Assessment (EA).

Level of Documentation

The proposed improvement options likely will include substantial revisions to the existing interchanges. As required by WSDOT's Design Manual Chapter 550 and FHWA, eight specific points will be addressed in the IJR. These policy points are:

- (1) Policy Point 1: Need for the Access Point Revision - What are the current and projected needs? Why are the existing access points and the existing or improved local system unable to meet the proposal needs? Is the anticipated demand short or long trip?
 - Using the Base Conditions operation analyses for 2013, 2020 and 2040 discuss the intersection and interstate deficiencies in access to the Interstate at the Thorne Lane, Berkeley Street, Main Gate and DuPont-Steilacoom Road interchanges.
 - Using the collision analysis, discuss the existing safety issues along I-5 and at the Thorne Lane, Berkeley Street, Main Gate and DuPont-Steilacoom Road interchanges and what it may look like in the future if changes do not occur.
- (2) Policy Point 2: Reasonable Alternatives - Describe the reasonable alternatives that have been evaluated.
 - Discuss all alternatives developed as part of this IJR and explain how these alternatives met or did not meet the purpose of the improvement.
 - Discuss why the selected alternative(s) were carried forward for further development.



- (3) Policy Point 3: Operational and Collision Analyses - How will the proposal affect safety and traffic operations at year of opening and design year?
- Discuss the results of the intersection and interstate operational analyses for the opening year (2020) and design year (2040) for the recommended Build Alternatives for this IJR.
 - Compare the results of the Build Alternatives with the Base Condition results, including the Thorne Lane, Berkeley Street, Main Gate and Steilacoom interchanges.
 - Determine the effect of the Build Alternatives on the I-5 mainline operations and adjacent interchanges at Gravelly Lake Road, and Center Drive Interchanges. If the impacts extend further north and south, also analyze the impacts to Mounts Road Interchange, Bridgeport Way Interchange and the SR 512 Interchange.
 - Discuss the collision analysis results for the Build Condition as compared to the Base Condition for the opening and design years.
 - Discuss impacts to safety and operation of I-5.
- (4) Policy Point 4: Access Connections and Design - Will the proposal provide fully directional interchanges connected to public streets or roads, spaced appropriately, and designed to full design level geometric control criteria?
- Discuss the geometric designs of the proposed improvements and show that all movements are included in the design.
 - Prepare conceptual horizontal and vertical alignments showing the existing I-5 mainline, proposed ramps and existing cross roads for the selected alternative.
 - Discuss design criteria, including ROW and access impacts.
- (5) Policy Point 5: Land Use and Transportation Plans - Is the proposed access point revision compatible with all land use and transportation plans for the area?
- Summarize how current land use assumptions are included in the travel demand model.
 - Discuss the improvement consistency with local, regional, and statewide transportation plans.
- (6) Policy Point 6: Future Interchanges - Is the proposed access point revision compatible with a comprehensive network plan? Is the proposal compatible with other known new access points and known revisions to existing points?
- Discuss the improvement consistency with other planned interstate improvements included in the State-wide Highway System Plan and refer to a future interstate master plan, including impacts of the Cross-Base highway.



(7) Policy Point 7: Coordination - Are all coordinating projects and actions programmed and funded?

- Discuss plans of the local jurisdictions to provide other local improvements to support the interstate modifications and that they will commit to work with WSDOT to pursue funds for the interchange modifications.
- Discuss any previous commitments between agencies or private entities; i.e. financial, environmental, etc.

(8) Policy Point 8: Environmental Processes - What is the status of the proposal's environmental processes? This section should be something more than just a status report of the environmental process; it should be a brief summary of the environmental process.

- Discuss the environmental findings, such as endangered species, priority habitats, wetlands and streams in the area and what environmental permits may be needed to implement the improvements.
- Discuss any known social issues that could affect this proposal.
- Discuss any known or potential hazardous contamination in the area.
- Discuss (if necessary) if the location is within a non-attainment area for air quality.
- Discuss that the environmental process must have WSDOT approval prior to the final IJR approval.

3. Analysis Years/Periods

Operational analysis will include AM, Midday and PM peak hours for the following years:

- Existing Base Year - 2013
- Assumed Opening Year - 2020
- Horizon/Design Year – 2040

A sensitivity analysis will also be conducted to assess approximately ten percent higher through traffic volumes along I-5 to account for increased Friday afternoon or Sunday evening situations.

4. Project Study Area

The project study area for this *I-5 JBLM Vicinity IJR* will extend from the I-5/Center Drive Interchange on the south to the I-5/Gravelly Lake Road Interchange on the north as illustrated on Figure 1. This area will include the following intersections for analyses:

- Center Drive Interchange (Exit #118)
 - Northbound Ramps
 - (JBLM outbound gate)
 - Southbound Ramps
 - Wilmington Drive/Center Drive
- DuPont-Steilacoom Road Interchange (Exit #119)
 - Northbound Ramps
 - Southbound Ramps
 - Wilmington Dr./Barksdale Ave.



- Main Gate Interchange (Exit # 120)
 - Northbound Ramps
 - Southbound Ramps
 - JBLM Gates
- Berkeley Street Interchange (Exit #122)
 - Northbound Ramps
 - Southbound Ramps
 - Union Avenue/Berkeley Street
- Thorne Lane Interchange (Exit #123)
 - Northbound Ramps
 - Southbound Ramps
 - Union Avenue/Thorne Lane
- Gravelly Lake Drive Interchange (Exit #124)
 - Northbound Ramps
 - Southbound Ramps
 - Pacific Highway S/Gravelly Lake Dr.

If the traffic analyses and the volumes changes show that there are impacts to adjacent interchanges further north or south, then they will be included in the project impact analysis, including:

- Mounts Road Interchange (Exit #116)
 - Northbound Ramps
 - Southbound Ramps
- SR 512 Interchange (Exit #127)
 - Southbound Off-ramp
- Bridgeport Way Interchange (Exit #125)
 - Northbound Ramps
 - Southbound Ramps
 - Pacific Highway S/Bridgeport Way

The study area for the travel demand model will include most of Pierce County and the north portion of Thurston County.

5. Traffic Operations Analysis

For interstate highway operations, the *2010 Highway Capacity Manual (HCM)* using the associated *Highway Capacity software (HCS)* (version 6.4) will be used to analyze mainline, merge/diverge connections and weaves situations. Average vehicle speed and density will be used as performance measures for the HCS analysis. For the three analysis years, AM, Midday and PM peak hour analyses will be performed.

For ramp terminal/surface street operations, intersections will be analyzed as follows:

- Synchro 8.0 software will be used to analyze the operations of signalized intersections.
- Synchro 8.0 software or HCS will be used to analyze unsignalized intersections.
- SIDRA 5.1 software package using standard model with HCS on will be used to analyze roundabout controlled intersections.
- SimTraffic software will be used to check Synchro results for ramp queuing.

For the preferred alternative, a simulation model capable of analyzing freeway and geometry between intersections and interchanges, including weaving sections and multiple vehicle classes will be used. VISSIM was selected for the simulation of the preferred alternative because it meets these needs while also providing animation graphics. The following VISSIM simulations will be prepared:

- Existing Year 2013 PM Peak Period (for model calibration)



- Design Year 2040 PM Peak Period for the Base Conditions
- Design Year 2040 PM Peak Period for the preferred alternative
- Design Year 2013 AM Peak Period (for model calibration)
- Design Year 2040 AM Peak Period for the Base Conditions
- Design Year 2040 AM Peak Period for the preferred alternative

For this report, the operational analysis area will include the I-5 corridor between Mounts Road and SR 512 interchanges and all ramp terminals.

6. Travel Forecast

The existing I-5/JBLM/Lakewood model developed for the *I-5 Alternatives Analysis Study* and consistent with the PSRC regional model will be utilized to develop forecasts for 2020 (year of opening) and 2040 (design year). In addition, the recent results and modeling efforts completed for the Lacey Area IJR will be used to help reconcile the differences between the PSRC and TRPC travel demand forecasts. This will include a more refined post-processing effort and rationale in balancing the vehicle demand and trips entering and exiting the Pierce/Thurston County line.

The 2020 model will include all local and regionally funded improvements and the 2040 model will include projects adopted in the region's Metropolitan Transportation Plan. Travel forecasts for the AM, mid-day, and PM peak periods and hours will be prepared.

Model Overview

The I-5/JBLM/Lakewood model was selected as the preferred model because it was specifically developed to support evaluation of I-5 mainline and interchange concepts in the JBLM vicinity. The available models in the area such as the PSRC, Pierce County, and TRPC models were not sufficiently refined in and around JBLM, Camp Murray, DuPont, and Lakewood to allow for the level of detail needed for an accurate assessment of I-5 and the area's transportation system. The I-5/JBLM/Lakewood model is a refined version of Pierce County's regional EMME model, but has been converted to the VISUM software platform. Transportation Analysis Zones (TAZs) have been subdivided to better model traffic patterns in the area and between major subareas of JBLM. Travel characteristics specific to the area have been introduced along with specific trip purposes and distribution for JBLM related travel to better model each of the interchanges and installation points of entry.

The model study area includes most of Pierce County, and some major highways and arterials in northeastern Thurston County. The base year model will be calibrated for AM, mid-day, and PM peak periods based on traffic counts collected during those times. Model parameters (screen lines, trip distribution, time-of day, etc.) will be validated based on FHWA guidelines. Consistency with PSRC and TRPC assumptions will be part of the model validation process. Given the recent work that has been completed for the Lacey Area IJR, the model calibration and post-processing will be sensitive to the travel forecast imbalance between the Pierce and Thurston county boundaries. The IJR team will work closely with TRPC and PSRC to solidify the model results to ensure a more accurate representation of



future travel characteristics are developed for this study. Testing of future scenarios will be conducted to review model sensitivity to changes in travel demand or the model network.

Freeway Traffic Forecasts

Forecasts will be developed for SOV and HOV classes of vehicles. Truck volumes will be estimated based upon available truck counts and existing truck percentages. HOV 2+ and HOV 3+ trip tables will be prepared based on PSRC model assumptions for each of the model time periods. In regards to transit, the VISUM model will not provide direct model data for transit vehicles, but it will be flexible to transit-related assumptions. The person-trip mode-split factors come from the PSRC model, and future year mode splits will reflect PSRC anticipated changes to transit in the future. For the I-5 JBLM specific zones, adjustments can be made to the mode split or time-of-day factors based on various transit scenario assumptions. The effect on traffic volumes will be scaled accordingly.

Interchange & Intersection Traffic Forecasts

Future interchange and intersection traffic volumes will be developed using travel forecasts from the model. The model travel forecasts for each time period will be post-processed and translated into vehicle volumes for use in the operations analysis. The interchange and intersection volumes will be balanced using the freeway ramp volumes as control totals.

7. Highway Network Assumptions

The following baseline conditions are assumed:

- 2013 Base Conditions
 - Existing Highway Network
- 2020 Base Conditions
 - Funded Tiger III Improvements
 - Funded TIP improvements from Local Jurisdictions
 - Funded STIP improvements
 - Funded JBLM Improvements
 - Funded rail improvements
 - Funded inter-regional transit and vanpool service
- 2040 Base Conditions
 - Same as 2020 Base Conditions.
 - Cross-Base Highway is not included as part of the base conditions.
- Modified 2040 Base with Unfunded Local Improvements
 - Local Improvements from the Long Range Regional Transportation Plan will be reviewed by the technical support group and selected improvements will be included.
 - Cross-Base Highway improvement will be analyzed for conditions with and without the corridor.



8. Build Highway Network Assumptions

- Build Alternatives 2020
 - Use same local highway network as developed for the 2020 Base Conditions.
 - Modify I-5 mainlines and ramps as approved by Stakeholders
- Build Alternatives 2040
 - Use same local highway network as developed for the Modified 2040 Base Conditions with and without the Cross-Base Highway.
 - Modify I-5 mainlines and ramps as approved by Stakeholders

9. Safety Issues

This IJR will use the current Collision Analysis Location/Collision Analysis Corridor (CAL/CAC) criteria and the Intersection Analysis Location (IAL) criteria for state highways within the project area. In addition, the collision rates along local streets will be estimated using available local collision data. Types of accidents and contributing factors to collisions will also be summarized by location. The most recent five years of available collision data will be used for this analysis. This corridor-specific information as well as statewide system collision statistics will be used in a predictive collision analysis effort to estimate any change in the level of safety for the interstate and connecting roadways.

Procedures developed in the Highway Safety Manual will be investigated for potential use in predicting future safety assessments of the preferred Build Alternative.

10. Deviations/Justifications

At this point in the process, there are no deviations identified. Deviations may be indentified through the various study results, and will be documented as they arise.

11. Selection of Measures of Effectiveness (MOE)

The metrics to be used to demonstrate how the proposal will accomplish the stated objectives will be aligned with the provisions outlined in the *Moving Washington* initiative. These metrics may include but not be limited to the following:

1. Traffic Operations along I-5 (Travel time and density)
2. Traffic Operations at ramp terminals (Average intersection delay and 95% queue lengths)
3. Impacts critical environmental habitat (Area impacted).
4. Safety Analysis Results (Accident Potential/Risk Reduction).
5. Travel time savings for freight movement
6. Reduction in SOV trips (identify goal) through increased TDM and transit ridership
7. Effect of “Managed Lanes” compared to general purpose (peak period SOV)
8. Design Standards/Deviations
9. Right of Way/Access Impacts



The list of criteria will be finalized as the evaluation methodology is developed with approval of the Stakeholders.

12. Resolution of Late Comments

From time to time, ideas or suggestions arise late in the evaluation or documentation process. Some of these late emerging ideas may have merit and added benefits to the project, but be difficult to incorporate in the on-going process. It is understood that new ideas may bring value to the final outcomes and therefore should not be automatically dismissed because of the sequence of events and timing of the information. Specific protocols will be in place to allow new ideas and information to be “vetted” and reviewed for consideration, as follows:

If new ideas and information are brought forward, they will be first discussed between WSDOT’s Project Manager and the Consultant’s Project Manager who will determine its merits. If they decide that the new idea has merit it will be referred to WSDOT/FHWA Core Team to decide how the new idea should be addressed in the IJR and environmental process. If the WSDOT and Consultant Project Managers decide that the idea has little merit, it will be added under policy point 2, if appropriate, and addressed as an idea considered.

For ideas that have already been considered and dismissed, but there is new interest in re-consideration, the WSDOT’s Project Manager and the Consultant’s Project Manager will determine if reintroducing the idea has merits. If they decide that the new idea has merit the idea will be referred to WSDOT/FHWA Core Team to decide how the revised idea should be addressed in the IJR and environmental process.



If a new idea and/or prior information is brought forward during a stakeholder meeting, the content of this information will not be fully discussed if it impacts the scheduled agenda. The Consultant’s Project Manager will note the comments and content of the information and will assure that review of the new information will follow the approved protocols for consideration.

A log of all late ideas and suggestions will be maintained by the Consultant’s Project Manager who will briefly summarize the idea or concept and show its status.

13. Conclusion

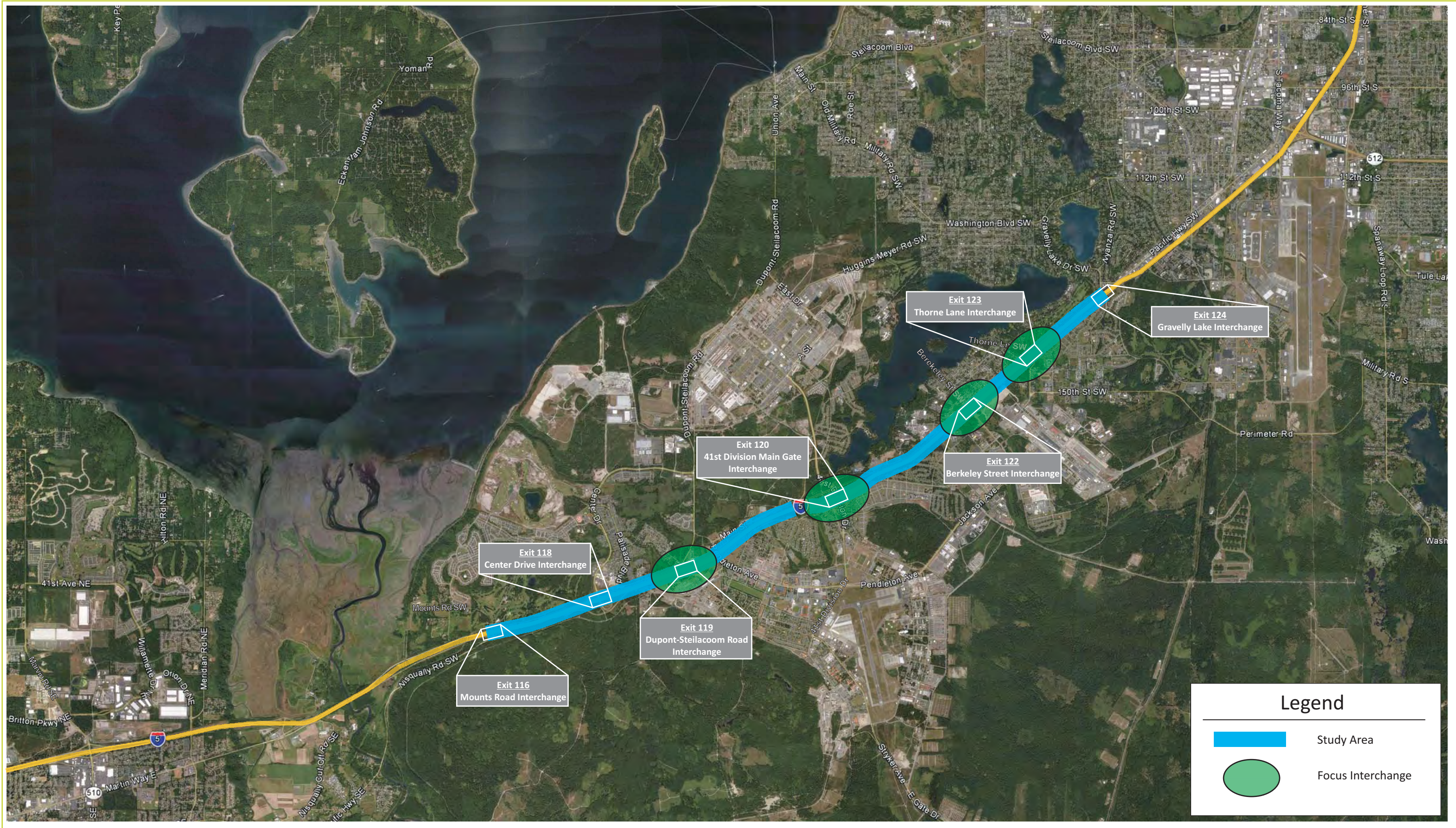
This study will review and analyze options for improving access to the Interstate system without degrading the mainline freeway or off-ramp operations and safety. While degradation of the Interstate system is not an acceptable outcome, there may be localized areas where degradation may occur due to system tradeoffs. Engineering judgment will be applied to arrive at the best overall set of improvements practical within the study area. This will be accomplished by thoroughly evaluating specific MOEs that are in alignment with the stated goals and the *Moving Washington* initiative.



Legend	
	Study Area
	Focus Interchange



Stakeholder Acceptance

"The undersigned party, in partnership with all members of the team from WSDOT, FHWA and the Local Agencies, concur with the Methods & Assumptions Document for the I-5 Joint Base Lewis-McChord Vicinity Interchange Justification Report (I-5 JBLM Vicinity IJR) as presented in this document."

Joint Base Lewis-McChord

Signature

Thomas Knight, Chief of Staff, Joint Base HQS, JBLM

Title

14 May 2013

Date

(1) Participation on the Stakeholders Committee and/or signing of this document does not constitute approval of the I-5 JBLM Vicinity IJR.

(2) All members of the Stakeholder Committee will accept this document as a guide and reference as the study progresses through the various stages of project development. If there are any agreed upon changes to the parameters set forth in this document a revision will be created, endorsed and signed by all the stakeholders.



Stakeholder Acceptance

"The undersigned party, in partnership with all members of the team from WSDOT, FHWA and the Local Agencies, concur with the Methods & Assumptions Document for the I-5 Joint Base Lewis-McChord Vicinity Interchange Justification Report (I-5 JBLM Vicinity IJR) as presented in this document."

Camp Murray

Signature

Planning and Programming Chief

Title

9 May 2013

Date

(1) Participation on the Stakeholders Committee and/or signing of this document does not constitute approval of the I-5 JBLM Vicinity IJR.

(2) All members of the Stakeholder Committee will accept this document as a guide and reference as the study progresses through the various stages of project development. If there are any agreed upon changes to the parameters set forth in this document a revision will be created, endorsed and signed by all the stakeholders.



Stakeholder Acceptance

"The undersigned party, in partnership with all members of the team from WSDOT, FHWA and the Local Agencies, concur with the Methods & Assumptions Document for the I-5 Joint Base Lewis-McChord Vicinity Interchange Justification Report (I-5 JBLM Vicinity IJR) as presented in this document."

City of DuPont

Signature

Title

Mayor of DuPont

Date

July 14, 2013

(1) Participation on the Stakeholders Committee and/or signing of this document does not constitute approval of the I-5 JBLM Vicinity IJR.

(2) All members of the Stakeholder Committee will accept this document as a guide and reference as the study progresses through the various stages of project development. If there are any agreed upon changes to the parameters set forth in this document a revision will be created, endorsed and signed by all the stakeholders.



Stakeholder Acceptance

"The undersigned party, in partnership with all members of the team from WSDOT, FHWA and the Local Agencies, concur with the Methods & Assumptions Document for the I-5 Joint Base Lewis-McChord Vicinity Interchange Justification Report (I-5 JBLM Vicinity IJR) as presented in this document."

Town of Steilacoom

Paul Lucas

Signature

MAYOR, TOWN OF STEILACOOM

Title

5/09/2013

Date

(1) Participation on the Stakeholders Committee and/or signing of this document does not constitute approval of the I-5 JBLM Vicinity IJR.

(2) All members of the Stakeholder Committee will accept this document as a guide and reference as the study progresses through the various stages of project development. If there are any agreed upon changes to the parameters set forth in this document a revision will be created, endorsed and signed by all the stakeholders.



Stakeholder Acceptance

"The undersigned party, in partnership with all members of the team from WSDOT, FHWA and the Local Agencies, concur with the Methods & Assumptions Document for the I-5 Joint Base Lewis-McChord Vicinity Interchange Justification Report (I-5 JBLM Vicinity IJR) as presented in this document."

Pierce County

Signature

Executive

Title

5-13-13

Date

(1) Participation on the Stakeholders Committee and/or signing of this document does not constitute approval of the I-5 JBLM Vicinity IJR.

(2) All members of the Stakeholder Committee will accept this document as a guide and reference as the study progresses through the various stages of project development. If there are any agreed upon changes to the parameters set forth in this document a revision will be created, endorsed and signed by all the stakeholders.

Stakeholder Acceptance

“The undersigned party, in partnership with all members of the team from WSDOT, FHWA and the Local Agencies, concur with the Methods & Assumptions Document for the I-5 Joint Base Lewis-McChord Vicinity Interchange Justification Report (I-5 JBLM Vicinity IJR) as presented in this document.”

Thurston Regional Planning Council

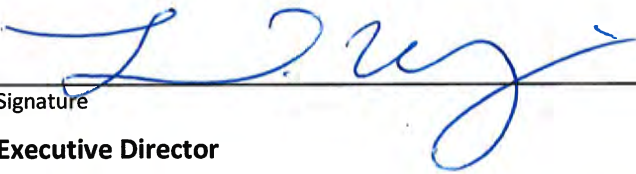

Signature

Executive Director

Title

July 11, 2013

Date

(1) Participation on the Stakeholders Committee and/or signing of this document does not constitute approval of the I-5 JBLM Vicinity IJR.

(2) All members of the Stakeholder Committee will accept this document as a guide and reference as the study progresses through the various stages of project development. If there are any agreed upon changes to the parameters set forth in this document a revision will be created, endorsed and signed by all the stakeholders.



Stakeholder Acceptance

"The undersigned party, in partnership with all members of the team from WSDOT, FHWA and the Local Agencies, concur with the Methods & Assumptions Document for the I-5 Joint Base Lewis-McChord Vicinity Interchange Justification Report (I-5 JBLM Vicinity IJR) as presented in this document."

Puget Sound Regional Council



Signature

Director of Integrated Planning

Title

July 11, 2013

Date

(1) Participation on the Stakeholders Committee and/or signing of this document does not constitute approval of the I-5 JBLM Vicinity IJR.

(2) All members of the Stakeholder Committee will accept this document as a guide and reference as the study progresses through the various stages of project development. If there are any agreed upon changes to the parameters set forth in this document a revision will be created, endorsed and signed by all the stakeholders.



Stakeholder Acceptance

"The undersigned party, in partnership with all members of the team from WSDOT, FHWA and the Local Agencies, concur with the Methods & Assumptions Document for the I-5 Joint Base Lewis-McChord Vicinity Interchange Justification Report (I-5 JBLM Vicinity IJR) as presented in this document."

WSDOT – Olympic Region



Signature

REGION ADMINISTRATOR

Title

MAY 13, 2013

Date

(1) Participation on the Stakeholders Committee and/or signing of this document does not constitute approval of the I-5 JBLM Vicinity IJR.

(2) All members of the Stakeholder Committee will accept this document as a guide and reference as the study progresses through the various stages of project development. If there are any agreed upon changes to the parameters set forth in this document a revision will be created, endorsed and signed by all the stakeholders.



Stakeholder Acceptance

"The undersigned party, in partnership with all members of the team from WSDOT, FHWA and the Local Agencies, concur with the Methods & Assumptions Document for the I-5 Joint Base Lewis-McChord Vicinity Interchange Justification Report (I-5 JBLM Vicinity IJR) as presented in this document."

WSDOT – Olympic Region Traffic

Signature

Title

Region Traffic Engineer

Date

May 14, 2013

- (1) Participation on the Stakeholders Committee and/or signing of this document does not constitute approval of the I-5 JBLM Vicinity IJR.
- (2) All members of the Stakeholder Committee will accept this document as a guide and reference as the study progresses through the various stages of project development. If there are any agreed upon changes to the parameters set forth in this document a revision will be created, endorsed and signed by all the stakeholders.



Stakeholder Acceptance

"The undersigned party, in partnership with all members of the team from WSDOT, FHWA and the Local Agencies, concur with the Methods & Assumptions Document for the I-5 Joint Base Lewis-McChord Vicinity Interchange Justification Report (I-5 JBLM Vicinity IJR) as presented in this document."

WSDOT – HQ Access and Hearings

Barb Del Crocif

Signature

Development Services & Account Mgr

Title

June 28, 2013

Date

(1) Participation on the Stakeholders Committee and/or signing of this document does not constitute approval of the I-5 JBLM Vicinity IJR.

(2) All members of the Stakeholder Committee will accept this document as a guide and reference as the study progresses through the various stages of project development. If there are any agreed upon changes to the parameters set forth in this document a revision will be created, endorsed and signed by all the stakeholders.



Stakeholder Acceptance

“The undersigned party, in partnership with all members of the team from WSDOT, FHWA and the Local Agencies, concur with the Methods & Assumptions Document for the I-5 Joint Base Lewis-McChord Vicinity Interchange Justification Report (I-5 JBLM Vicinity IJR) as presented in this document.”

Federal Highway Administration

Daniel M. Mathis

Signature

Division Administrator

Title

July 16, 2013

Date

(1) Participation on the Stakeholders Committee and/or signing of this document does not constitute approval of the I-5 JBLM Vicinity IJR.

(2) All members of the Stakeholder Committee will accept this document as a guide and reference as the study progresses through the various stages of project development. If there are any agreed upon changes to the parameters set forth in this document a revision will be created, endorsed and signed by all the stakeholders.

Appendix B

Summary of Intersection Turning Movement Volumes

This Page Intentionally Left Blank

AM PEAK HOUR TURNING MOVEMENT SUMMARY

Post-processed Data
from Mesoscopic Model

	Post-Processed EXISTING 2013 Model Volumes Peak Hour	Post-Processed NO BUILD P1 2020 Volumes Peak Hour	Post-Processed BUILD RB_sbGLC_noHOV_2020 Volumes Peak Hour	Post-Processed NO BUILD P1 2040 Volumes Peak Hour	Post-Processed BUILD RB_sbGLC_noHOV_2040 Volume Peak Hour										
<p>North-South Street East-West Street</p> <p>Count Date: 3/5/2013</p> <p>Count Source: TC2</p> <table border="1"> <tr><td>EB</td><td>WB</td><td>NB</td><td>SB</td><td>Total</td></tr> <tr><td>0%</td><td>1%</td><td>2%</td><td>1%</td><td></td></tr> </table> <p>PHF 0.85</p> <p>Peak Hour Used:</p> <p>From 715 To 815</p>	EB	WB	NB	SB	Total	0%	1%	2%	1%		<p>3 Center Dr 2013 Wilmington Dr</p>	<p>3 Center Dr 2020 Wilmington Dr</p>	<p>3 Center Dr 2020 Wilmington Dr</p>	<p>Center Dr Wilmington Dr</p>	<p>3 Center Dr 2040 Wilmington Dr</p>
EB	WB	NB	SB	Total											
0%	1%	2%	1%												
<p>North-South Street East-West Street</p> <p>Count Date: 3/5/2013</p> <p>Count Source: TC2</p> <table border="1"> <tr><td>EB</td><td>WB</td><td>NB</td><td>SB</td><td>Total</td></tr> <tr><td></td><td>1%</td><td>1%</td><td>1%</td><td></td></tr> </table> <p>PHF 0.86</p> <p>Peak Hour Used:</p> <p>From 715 To 815</p>	EB	WB	NB	SB	Total		1%	1%	1%		<p>4 Center Dr 2013 SB I-5 Ramps</p>	<p>4 Center Dr 2020 SB I-5 Ramps</p>	<p>4 Center Dr 2020 SB I-5 Ramps</p>	<p>Center Dr SB I-5 Ramps</p>	<p>4 Center Dr 2040 SB I-5 Ramps</p>
EB	WB	NB	SB	Total											
	1%	1%	1%												
<p>North-South Street East-West Street</p> <p>Count Date: 3/5/2013</p> <p>Count Source: TC2</p> <table border="1"> <tr><td>EB</td><td>WB</td><td>NB</td><td>SB</td><td>Total</td></tr> <tr><td></td><td></td><td>1%</td><td>1%</td><td></td></tr> </table> <p>PHF 0.86</p> <p>Peak Hour Used:</p> <p>From 715 To 815</p>	EB	WB	NB	SB	Total			1%	1%		<p>5 Center Dr 2013 NB I-5 Ramps</p>	<p>5 Center Dr 2020 NB I-5 Ramps</p>	<p>5 Center Dr 2020 NB I-5 Ramps</p>	<p>Center Dr NB I-5 Ramps</p>	<p>5 Center Dr 2040 NB I-5 Ramps</p>
EB	WB	NB	SB	Total											
		1%	1%												
<p>North-South Street East-West Street</p> <p>Count Date: 2/14/2013</p> <p>Count Source: TC2</p> <table border="1"> <tr><td>EB</td><td>WB</td><td>NB</td><td>SB</td><td>Total</td></tr> <tr><td>8%</td><td>15%</td><td>4%</td><td>7%</td><td></td></tr> </table> <p>PHF 0.89</p> <p>Peak Hour Used:</p> <p>From 715 To 815</p>	EB	WB	NB	SB	Total	8%	15%	4%	7%		<p>6 Steilacoom-DuPont Rd 2013 Wilmington Dr</p>	<p>6 Barksdale Ave 2020 Wilmington Dr</p>	<p>6 Barksdale Ave 2020 Wilmington Dr</p>	<p>Barksdale Ave Wilmington Dr</p>	<p>6 Barksdale Ave 2040 Wilmington Dr</p>
EB	WB	NB	SB	Total											
8%	15%	4%	7%												

AM PEAK HOUR TURNING MOVEMENT SUMMARY

Post-processed Data
from Mesoscopic Model

	Post-Processed EXISTING 2013 Model Volumes Peak Hour	Post-Processed NO BUILD P1 2020 Volumes Peak Hour	Post-Processed BUILD RB_sbGLC_noHOV_2020 Volumes Peak Hour	Post-Processed NO BUILD P1 2040 Volumes Peak Hour	Post-Processed BUILD RB_sbGLC_noHOV_2040 Volume Peak Hour																																																																																																																																															
<table border="1"> <tr><th colspan="2">North-South Street</th></tr> <tr><th colspan="2">East-West Street</th></tr> <tr><td>Count Date:</td><td>2/14/2013</td></tr> <tr><td>Count Source:</td><td>TC2</td></tr> <tr><td>EB</td><td>WB</td><td>NB</td><td>SB</td><td>Total</td></tr> <tr><td>%HV</td><td>3%</td><td>2%</td><td>9%</td><td></td></tr> <tr><td>PHF</td><td colspan="4">0.90</td></tr> <tr><td colspan="5">Peak Hour Used:</td></tr> <tr><td>From</td><td>715</td><td>To</td><td>815</td><td></td></tr> </table>	North-South Street		East-West Street		Count Date:	2/14/2013	Count Source:	TC2	EB	WB	NB	SB	Total	%HV	3%	2%	9%		PHF	0.90				Peak Hour Used:					From	715	To	815		<table border="1"> <tr><th colspan="2">Steilacoom-DuPont Rd</th></tr> <tr><th colspan="2">2013 SB I-5 Ramps</th></tr> <tr><td>685</td><td>860</td></tr> <tr><td>270</td><td>415</td></tr> <tr><td>460</td><td>445</td><td>610</td></tr> <tr><td colspan="2">1,900</td></tr> <tr><td>0</td><td>165</td><td>0</td></tr> <tr><td>190</td><td>415</td></tr> <tr><td>580</td><td>605</td></tr> </table>	Steilacoom-DuPont Rd		2013 SB I-5 Ramps		685	860	270	415	460	445	610	1,900		0	165	0	190	415	580	605	<table border="1"> <tr><th colspan="2">Steilacoom-DuPont Rd</th></tr> <tr><th colspan="2">2020 SB I-5 Ramps</th></tr> <tr><td>735</td><td>1,210</td></tr> <tr><td>285</td><td>450</td></tr> <tr><td>465</td><td>655</td><td>830</td></tr> <tr><td colspan="2">2,300</td></tr> <tr><td>0</td><td>175</td><td>0</td></tr> <tr><td>180</td><td>555</td></tr> <tr><td>625</td><td>735</td></tr> </table>	Steilacoom-DuPont Rd		2020 SB I-5 Ramps		735	1,210	285	450	465	655	830	2,300		0	175	0	180	555	625	735	<table border="1"> <tr><th colspan="2">Steilacoom-DuPont Rd</th></tr> <tr><th colspan="2">2020 SB I-5 Ramps</th></tr> <tr><td>745</td><td>1,210</td></tr> <tr><td>270</td><td>475</td></tr> <tr><td>460</td><td>660</td><td>845</td></tr> <tr><td colspan="2">2,330</td></tr> <tr><td>0</td><td>185</td><td>0</td></tr> <tr><td>190</td><td>550</td></tr> <tr><td>660</td><td>740</td></tr> </table>	Steilacoom-DuPont Rd		2020 SB I-5 Ramps		745	1,210	270	475	460	660	845	2,330		0	185	0	190	550	660	740	<table border="1"> <tr><th colspan="2">Steilacoom-DuPont Rd</th></tr> <tr><th colspan="2">SB I-5 Ramps</th></tr> <tr><td>770</td><td>1,410</td></tr> <tr><td>315</td><td>455</td></tr> <tr><td>0</td><td>785</td><td>950</td></tr> <tr><td colspan="2">2,520</td></tr> <tr><td>0</td><td>165</td><td>0</td></tr> <tr><td>175</td><td>625</td></tr> <tr><td>620</td><td>800</td></tr> </table>	Steilacoom-DuPont Rd		SB I-5 Ramps		770	1,410	315	455	0	785	950	2,520		0	165	0	175	625	620	800	<table border="1"> <tr><th colspan="2">Steilacoom-DuPont Rd</th></tr> <tr><th colspan="2">2020 SB I-5 Ramps</th></tr> <tr><td>775</td><td>1,450</td></tr> <tr><td>290</td><td>485</td></tr> <tr><td>475</td><td>840</td><td>1,000</td></tr> <tr><td colspan="2">2,570</td></tr> <tr><td>0</td><td>160</td><td>0</td></tr> <tr><td>185</td><td>610</td></tr> <tr><td>645</td><td>795</td></tr> </table>	Steilacoom-DuPont Rd		2020 SB I-5 Ramps		775	1,450	290	485	475	840	1,000	2,570		0	160	0	185	610	645	795										
North-South Street																																																																																																																																																				
East-West Street																																																																																																																																																				
Count Date:	2/14/2013																																																																																																																																																			
Count Source:	TC2																																																																																																																																																			
EB	WB	NB	SB	Total																																																																																																																																																
%HV	3%	2%	9%																																																																																																																																																	
PHF	0.90																																																																																																																																																			
Peak Hour Used:																																																																																																																																																				
From	715	To	815																																																																																																																																																	
Steilacoom-DuPont Rd																																																																																																																																																				
2013 SB I-5 Ramps																																																																																																																																																				
685	860																																																																																																																																																			
270	415																																																																																																																																																			
460	445	610																																																																																																																																																		
1,900																																																																																																																																																				
0	165	0																																																																																																																																																		
190	415																																																																																																																																																			
580	605																																																																																																																																																			
Steilacoom-DuPont Rd																																																																																																																																																				
2020 SB I-5 Ramps																																																																																																																																																				
735	1,210																																																																																																																																																			
285	450																																																																																																																																																			
465	655	830																																																																																																																																																		
2,300																																																																																																																																																				
0	175	0																																																																																																																																																		
180	555																																																																																																																																																			
625	735																																																																																																																																																			
Steilacoom-DuPont Rd																																																																																																																																																				
2020 SB I-5 Ramps																																																																																																																																																				
745	1,210																																																																																																																																																			
270	475																																																																																																																																																			
460	660	845																																																																																																																																																		
2,330																																																																																																																																																				
0	185	0																																																																																																																																																		
190	550																																																																																																																																																			
660	740																																																																																																																																																			
Steilacoom-DuPont Rd																																																																																																																																																				
SB I-5 Ramps																																																																																																																																																				
770	1,410																																																																																																																																																			
315	455																																																																																																																																																			
0	785	950																																																																																																																																																		
2,520																																																																																																																																																				
0	165	0																																																																																																																																																		
175	625																																																																																																																																																			
620	800																																																																																																																																																			
Steilacoom-DuPont Rd																																																																																																																																																				
2020 SB I-5 Ramps																																																																																																																																																				
775	1,450																																																																																																																																																			
290	485																																																																																																																																																			
475	840	1,000																																																																																																																																																		
2,570																																																																																																																																																				
0	160	0																																																																																																																																																		
185	610																																																																																																																																																			
645	795																																																																																																																																																			
<table border="1"> <tr><th colspan="2">North-South Street</th></tr> <tr><th colspan="2">East-West Street</th></tr> <tr><td>Count Date:</td><td>2/14/2013</td></tr> <tr><td>Count Source:</td><td>TC2</td></tr> <tr><td>EB</td><td>WB</td><td>NB</td><td>SB</td><td>Total</td></tr> <tr><td>%HV</td><td>1%</td><td>1%</td><td>7%</td><td></td></tr> <tr><td>PHF</td><td colspan="4">0.83</td></tr> <tr><td colspan="5">Peak Hour Used:</td></tr> <tr><td>From</td><td>715</td><td>To</td><td>815</td><td></td></tr> </table>	North-South Street		East-West Street		Count Date:	2/14/2013	Count Source:	TC2	EB	WB	NB	SB	Total	%HV	1%	1%	7%		PHF	0.83				Peak Hour Used:					From	715	To	815		<table border="1"> <tr><th colspan="2">Steilacoom-DuPont Rd</th></tr> <tr><th colspan="2">2013 NB I-5 Ramps</th></tr> <tr><td>580</td><td>605</td></tr> <tr><td>320</td><td>375</td><td>205</td></tr> <tr><td>0</td><td>1,820</td></tr> <tr><td>880</td><td>555</td><td>285</td></tr> <tr><td>285</td><td>75</td></tr> <tr><td>930</td><td>360</td></tr> </table>	Steilacoom-DuPont Rd		2013 NB I-5 Ramps		580	605	320	375	205	0	1,820	880	555	285	285	75	930	360	<table border="1"> <tr><th colspan="2">Steilacoom-DuPont Rd</th></tr> <tr><th colspan="2">2020 NB I-5 Ramps</th></tr> <tr><td>625</td><td>735</td></tr> <tr><td>0</td><td>410</td><td>215</td></tr> <tr><td>0</td><td>2,055</td></tr> <tr><td>990</td><td>615</td><td>295</td></tr> <tr><td>0</td><td>365</td><td>75</td></tr> <tr><td>1,025</td><td>440</td></tr> </table>	Steilacoom-DuPont Rd		2020 NB I-5 Ramps		625	735	0	410	215	0	2,055	990	615	295	0	365	75	1,025	440	<table border="1"> <tr><th colspan="2">Steilacoom-DuPont Rd</th></tr> <tr><th colspan="2">2020 NB I-5 Ramps</th></tr> <tr><td>660</td><td>740</td></tr> <tr><td>0</td><td>405</td><td>255</td></tr> <tr><td>0</td><td>2,125</td></tr> <tr><td>1,025</td><td>640</td><td>340</td></tr> <tr><td>0</td><td>360</td><td>80</td></tr> <tr><td>1,045</td><td>440</td></tr> </table>	Steilacoom-DuPont Rd		2020 NB I-5 Ramps		660	740	0	405	255	0	2,125	1,025	640	340	0	360	80	1,045	440	<table border="1"> <tr><th colspan="2">Steilacoom-DuPont Rd</th></tr> <tr><th colspan="2">NB I-5 Ramps</th></tr> <tr><td>620</td><td>800</td></tr> <tr><td>0</td><td>415</td><td>205</td></tr> <tr><td>400</td><td>1,885</td></tr> <tr><td>5</td><td>0</td><td>0</td></tr> <tr><td>380</td><td>0</td><td>290</td></tr> <tr><td>0</td><td>400</td><td>80</td></tr> <tr><td>795</td><td>480</td></tr> </table>	Steilacoom-DuPont Rd		NB I-5 Ramps		620	800	0	415	205	400	1,885	5	0	0	380	0	290	0	400	80	795	480	<table border="1"> <tr><th colspan="2">Steilacoom-DuPont Rd</th></tr> <tr><th colspan="2">2020 NB I-5 Ramps</th></tr> <tr><td>645</td><td>795</td></tr> <tr><td>0</td><td>410</td><td>235</td></tr> <tr><td>0</td><td>2,010</td></tr> <tr><td>895</td><td>495</td><td>310</td></tr> <tr><td>0</td><td>400</td><td>70</td></tr> <tr><td>905</td><td>470</td></tr> </table>	Steilacoom-DuPont Rd		2020 NB I-5 Ramps		645	795	0	410	235	0	2,010	895	495	310	0	400	70	905	470													
North-South Street																																																																																																																																																				
East-West Street																																																																																																																																																				
Count Date:	2/14/2013																																																																																																																																																			
Count Source:	TC2																																																																																																																																																			
EB	WB	NB	SB	Total																																																																																																																																																
%HV	1%	1%	7%																																																																																																																																																	
PHF	0.83																																																																																																																																																			
Peak Hour Used:																																																																																																																																																				
From	715	To	815																																																																																																																																																	
Steilacoom-DuPont Rd																																																																																																																																																				
2013 NB I-5 Ramps																																																																																																																																																				
580	605																																																																																																																																																			
320	375	205																																																																																																																																																		
0	1,820																																																																																																																																																			
880	555	285																																																																																																																																																		
285	75																																																																																																																																																			
930	360																																																																																																																																																			
Steilacoom-DuPont Rd																																																																																																																																																				
2020 NB I-5 Ramps																																																																																																																																																				
625	735																																																																																																																																																			
0	410	215																																																																																																																																																		
0	2,055																																																																																																																																																			
990	615	295																																																																																																																																																		
0	365	75																																																																																																																																																		
1,025	440																																																																																																																																																			
Steilacoom-DuPont Rd																																																																																																																																																				
2020 NB I-5 Ramps																																																																																																																																																				
660	740																																																																																																																																																			
0	405	255																																																																																																																																																		
0	2,125																																																																																																																																																			
1,025	640	340																																																																																																																																																		
0	360	80																																																																																																																																																		
1,045	440																																																																																																																																																			
Steilacoom-DuPont Rd																																																																																																																																																				
NB I-5 Ramps																																																																																																																																																				
620	800																																																																																																																																																			
0	415	205																																																																																																																																																		
400	1,885																																																																																																																																																			
5	0	0																																																																																																																																																		
380	0	290																																																																																																																																																		
0	400	80																																																																																																																																																		
795	480																																																																																																																																																			
Steilacoom-DuPont Rd																																																																																																																																																				
2020 NB I-5 Ramps																																																																																																																																																				
645	795																																																																																																																																																			
0	410	235																																																																																																																																																		
0	2,010																																																																																																																																																			
895	495	310																																																																																																																																																		
0	400	70																																																																																																																																																		
905	470																																																																																																																																																			
<table border="1"> <tr><th colspan="2">North-South Street</th></tr> <tr><th colspan="2">East-West Street</th></tr> <tr><td>Count Date:</td><td>2/13/2013</td></tr> <tr><td>Count Source:</td><td>TC2 (tube)</td></tr> <tr><td>EB</td><td>WB</td><td>NB</td><td>SB</td><td>Total</td></tr> <tr><td>%HV</td><td colspan="4">0.89</td></tr> <tr><td>PHF</td><td colspan="4">0.89</td></tr> <tr><td colspan="5">Peak Hour Used:</td></tr> <tr><td>From</td><td>715</td><td>To</td><td>815</td><td></td></tr> </table>	North-South Street		East-West Street		Count Date:	2/13/2013	Count Source:	TC2 (tube)	EB	WB	NB	SB	Total	%HV	0.89				PHF	0.89				Peak Hour Used:					From	715	To	815		<table border="1"> <tr><th colspan="2">41ST DIVISION DR S</th></tr> <tr><th colspan="2">2013 I-5 SB Off Ramp</th></tr> <tr><td>1,095</td><td>770</td></tr> <tr><td>180</td><td>915</td></tr> <tr><td>420</td><td>240</td><td>240</td></tr> <tr><td colspan="2">2,445</td></tr> <tr><td>420</td><td>160</td></tr> <tr><td>530</td><td>160</td></tr> <tr><td>1,335</td><td>690</td></tr> </table>	41ST DIVISION DR S		2013 I-5 SB Off Ramp		1,095	770	180	915	420	240	240	2,445		420	160	530	160	1,335	690	<table border="1"> <tr><th colspan="2">41ST DIVISION DR S</th></tr> <tr><th colspan="2">2020 I-5 SB Off Ramp</th></tr> <tr><td>1,015</td><td>440</td></tr> <tr><td>185</td><td>830</td></tr> <tr><td>185</td><td>120</td><td>120</td></tr> <tr><td colspan="2">2,050</td></tr> <tr><td>390</td><td>205</td></tr> <tr><td>390</td><td>0</td></tr> <tr><td>0</td><td>320</td><td>205</td></tr> <tr><td>1,220</td><td>525</td></tr> </table>	41ST DIVISION DR S		2020 I-5 SB Off Ramp		1,015	440	185	830	185	120	120	2,050		390	205	390	0	0	320	205	1,220	525	<table border="1"> <tr><th colspan="2">41ST DIVISION DR S</th></tr> <tr><th colspan="2">2020 I-5 SB Off Ramp</th></tr> <tr><td>1,060</td><td>450</td></tr> <tr><td>185</td><td>875</td></tr> <tr><td>185</td><td>135</td><td>135</td></tr> <tr><td colspan="2">2,070</td></tr> <tr><td>345</td><td>215</td></tr> <tr><td>345</td><td>0</td></tr> <tr><td>0</td><td>315</td><td>215</td></tr> <tr><td>1,220</td><td>530</td></tr> </table>	41ST DIVISION DR S		2020 I-5 SB Off Ramp		1,060	450	185	875	185	135	135	2,070		345	215	345	0	0	315	215	1,220	530	<table border="1"> <tr><th colspan="2">41ST DIVISION DR S</th></tr> <tr><th colspan="2">I-5 SB Off Ramp</th></tr> <tr><td>985</td><td>480</td></tr> <tr><td>205</td><td>780</td></tr> <tr><td>0</td><td>75</td><td>75</td></tr> <tr><td colspan="2">2,000</td></tr> <tr><td>290</td><td>245</td></tr> <tr><td>290</td><td>0</td></tr> <tr><td>0</td><td>405</td><td>245</td></tr> <tr><td>1,070</td><td>650</td></tr> </table>	41ST DIVISION DR S		I-5 SB Off Ramp		985	480	205	780	0	75	75	2,000		290	245	290	0	0	405	245	1,070	650	<table border="1"> <tr><th colspan="2">41ST DIVISION DR S</th></tr> <tr><th colspan="2">2020 I-5 SB Off Ramp</th></tr> <tr><td>1,075</td><td>475</td></tr> <tr><td>220</td><td>855</td></tr> <tr><td>220</td><td>75</td><td>75</td></tr> <tr><td colspan="2">2,090</td></tr> <tr><td>330</td><td>210</td></tr> <tr><td>330</td><td>0</td></tr> <tr><td>0</td><td>400</td><td>210</td></tr> <tr><td>1,185</td><td>610</td></tr> </table>	41ST DIVISION DR S		2020 I-5 SB Off Ramp		1,075	475	220	855	220	75	75	2,090		330	210	330	0	0	400	210	1,185	610			
North-South Street																																																																																																																																																				
East-West Street																																																																																																																																																				
Count Date:	2/13/2013																																																																																																																																																			
Count Source:	TC2 (tube)																																																																																																																																																			
EB	WB	NB	SB	Total																																																																																																																																																
%HV	0.89																																																																																																																																																			
PHF	0.89																																																																																																																																																			
Peak Hour Used:																																																																																																																																																				
From	715	To	815																																																																																																																																																	
41ST DIVISION DR S																																																																																																																																																				
2013 I-5 SB Off Ramp																																																																																																																																																				
1,095	770																																																																																																																																																			
180	915																																																																																																																																																			
420	240	240																																																																																																																																																		
2,445																																																																																																																																																				
420	160																																																																																																																																																			
530	160																																																																																																																																																			
1,335	690																																																																																																																																																			
41ST DIVISION DR S																																																																																																																																																				
2020 I-5 SB Off Ramp																																																																																																																																																				
1,015	440																																																																																																																																																			
185	830																																																																																																																																																			
185	120	120																																																																																																																																																		
2,050																																																																																																																																																				
390	205																																																																																																																																																			
390	0																																																																																																																																																			
0	320	205																																																																																																																																																		
1,220	525																																																																																																																																																			
41ST DIVISION DR S																																																																																																																																																				
2020 I-5 SB Off Ramp																																																																																																																																																				
1,060	450																																																																																																																																																			
185	875																																																																																																																																																			
185	135	135																																																																																																																																																		
2,070																																																																																																																																																				
345	215																																																																																																																																																			
345	0																																																																																																																																																			
0	315	215																																																																																																																																																		
1,220	530																																																																																																																																																			
41ST DIVISION DR S																																																																																																																																																				
I-5 SB Off Ramp																																																																																																																																																				
985	480																																																																																																																																																			
205	780																																																																																																																																																			
0	75	75																																																																																																																																																		
2,000																																																																																																																																																				
290	245																																																																																																																																																			
290	0																																																																																																																																																			
0	405	245																																																																																																																																																		
1,070	650																																																																																																																																																			
41ST DIVISION DR S																																																																																																																																																				
2020 I-5 SB Off Ramp																																																																																																																																																				
1,075	475																																																																																																																																																			
220	855																																																																																																																																																			
220	75	75																																																																																																																																																		
2,090																																																																																																																																																				
330	210																																																																																																																																																			
330	0																																																																																																																																																			
0	400	210																																																																																																																																																		
1,185	610																																																																																																																																																			
<table border="1"> <tr><th colspan="2">North-South Street</th></tr> <tr><th colspan="2">East-West Street</th></tr> <tr><td>Count Date:</td><td>2/13/2013</td></tr> <tr><td>Count Source:</td><td>TC2 (tube)</td></tr> <tr><td>EB</td><td>WB</td><td>NB</td><td>SB</td><td>Total</td></tr> <tr><td>%HV</td><td colspan="4">0.91</td></tr> <tr><td>PHF</td><td colspan="4">0.91</td></tr> <tr><td colspan="5">Peak Hour Used:</td></tr> <tr><td>From</td><td>715</td><td>To</td><td>815</td><td></td></tr> </table>	North-South Street		East-West Street		Count Date:	2/13/2013	Count Source:	TC2 (tube)	EB	WB	NB	SB	Total	%HV	0.91				PHF	0.91				Peak Hour Used:					From	715	To	815		<table border="1"> <tr><th colspan="2">41ST DIVISION DR S</th></tr> <tr><th colspan="2">2013 I-5 NB Off Ramp</th></tr> <tr><td>1,335</td><td>690</td></tr> <tr><td>380</td><td>955</td></tr> <tr><td>380</td><td>200</td><td>200</td></tr> <tr><td colspan="2">2,610</td></tr> <tr><td>285</td><td>300</td></tr> <tr><td>285</td><td>0</td></tr> <tr><td>0</td><td>490</td><td>300</td></tr> <tr><td>1,240</td><td>790</td></tr> </table>	41ST DIVISION DR S		2013 I-5 NB Off Ramp		1,335	690	380	955	380	200	200	2,610		285	300	285	0	0	490	300	1,240	790	<table border="1"> <tr><th colspan="2">41ST DIVISION DR S</th></tr> <tr><th colspan="2">2020 I-5 NB Off Ramp</th></tr> <tr><td>1,220</td><td>525</td></tr> <tr><td>300</td><td>920</td></tr> <tr><td>300</td><td>75</td><td>75</td></tr> <tr><td colspan="2">2,310</td></tr> <tr><td>305</td><td>260</td></tr> <tr><td>305</td><td>0</td></tr> <tr><td>0</td><td>450</td><td>260</td></tr> <tr><td>1,225</td><td>710</td></tr> </table>	41ST DIVISION DR S		2020 I-5 NB Off Ramp		1,220	525	300	920	300	75	75	2,310		305	260	305	0	0	450	260	1,225	710	<table border="1"> <tr><th colspan="2">41ST DIVISION DR S</th></tr> <tr><th colspan="2">2020 I-5 NB Off Ramp</th></tr> <tr><td>1,220</td><td>530</td></tr> <tr><td>370</td><td>850</td></tr> <tr><td>370</td><td>65</td><td>65</td></tr> <tr><td colspan="2">2,320</td></tr> <tr><td>300</td><td>270</td></tr> <tr><td>300</td><td>0</td></tr> <tr><td>0</td><td>465</td><td>270</td></tr> <tr><td>1,150</td><td>735</td></tr> </table>	41ST DIVISION DR S		2020 I-5 NB Off Ramp		1,220	530	370	850	370	65	65	2,320		300	270	300	0	0	465	270	1,150	735	<table border="1"> <tr><th colspan="2">41ST DIVISION DR S</th></tr> <tr><th colspan="2">I-5 NB Off Ramp</th></tr> <tr><td>1,070</td><td>650</td></tr> <tr><td>215</td><td>855</td></tr> <tr><td>0</td><td>135</td><td>135</td></tr> <tr><td colspan="2">2,380</td></tr> <tr><td>355</td><td>305</td></tr> <tr><td>355</td><td>0</td></tr> <tr><td>0</td><td>515</td><td>305</td></tr> <tr><td>1,210</td><td>820</td></tr> </table>	41ST DIVISION DR S		I-5 NB Off Ramp		1,070	650	215	855	0	135	135	2,380		355	305	355	0	0	515	305	1,210	820	<table border="1"> <tr><th colspan="2">41ST DIVISION DR S</th></tr> <tr><th colspan="2">2020 I-5 NB Off Ramp</th></tr> <tr><td>1,095</td><td>460</td></tr> <tr><td>220</td><td>875</td></tr> <tr><td>220</td><td>100</td><td>100</td></tr> <tr><td colspan="2">2,150</td></tr> <tr><td>360</td><td>235</td></tr> <tr><td>360</td><td>0</td></tr> <tr><td>0</td><td>360</td><td>235</td></tr> <tr><td>1,235</td><td>595</td></tr> </table>	41ST DIVISION DR S		2020 I-5 NB Off Ramp		1,095	460	220	875	220	100	100	2,150		360	235	360	0	0	360	235	1,235	595
North-South Street																																																																																																																																																				
East-West Street																																																																																																																																																				
Count Date:	2/13/2013																																																																																																																																																			
Count Source:	TC2 (tube)																																																																																																																																																			
EB	WB	NB	SB	Total																																																																																																																																																
%HV	0.91																																																																																																																																																			
PHF	0.91																																																																																																																																																			
Peak Hour Used:																																																																																																																																																				
From	715	To	815																																																																																																																																																	
41ST DIVISION DR S																																																																																																																																																				
2013 I-5 NB Off Ramp																																																																																																																																																				
1,335	690																																																																																																																																																			
380	955																																																																																																																																																			
380	200	200																																																																																																																																																		
2,610																																																																																																																																																				
285	300																																																																																																																																																			
285	0																																																																																																																																																			
0	490	300																																																																																																																																																		
1,240	790																																																																																																																																																			
41ST DIVISION DR S																																																																																																																																																				
2020 I-5 NB Off Ramp																																																																																																																																																				
1,220	525																																																																																																																																																			
300	920																																																																																																																																																			
300	75	75																																																																																																																																																		
2,310																																																																																																																																																				
305	260																																																																																																																																																			
305	0																																																																																																																																																			
0	450	260																																																																																																																																																		
1,225	710																																																																																																																																																			
41ST DIVISION DR S																																																																																																																																																				
2020 I-5 NB Off Ramp																																																																																																																																																				
1,220	530																																																																																																																																																			
370	850																																																																																																																																																			
370	65	65																																																																																																																																																		
2,320																																																																																																																																																				
300	270																																																																																																																																																			
300	0																																																																																																																																																			
0	465	270																																																																																																																																																		
1,150	735																																																																																																																																																			
41ST DIVISION DR S																																																																																																																																																				
I-5 NB Off Ramp																																																																																																																																																				
1,070	650																																																																																																																																																			
215	855																																																																																																																																																			
0	135	135																																																																																																																																																		
2,380																																																																																																																																																				
355	305																																																																																																																																																			
355	0																																																																																																																																																			
0	515	305																																																																																																																																																		
1,210	820																																																																																																																																																			
41ST DIVISION DR S																																																																																																																																																				
2020 I-5 NB Off Ramp																																																																																																																																																				
1,095	460																																																																																																																																																			
220	875																																																																																																																																																			
220	100	100																																																																																																																																																		
2,150																																																																																																																																																				
360	235																																																																																																																																																			
360	0																																																																																																																																																			
0	360	235																																																																																																																																																		
1,235	595																																																																																																																																																			

AM PEAK HOUR TURNING MOVEMENT SUMMARY

Post-processed Data
from Mesoscopic Model

	Post-Processed EXISTING 2013 Model Volumes Peak Hour	Post-Processed NO BUILD P1 2020 Volumes Peak Hour	Post-Processed BUILD RB_sbGLC_noHOV_2020 Volumes Peak Hour	Post-Processed NO BUILD P1 2040 Volumes Peak Hour	Post-Processed BUILD RB_sbGLC_noHOV_2040 Volume Peak Hour																																																																																																												
<table border="1"> <tr><td>North-South Street</td><td>East-West Street</td></tr> <tr><td>NEW INTERSECTION</td><td></td></tr> <tr><td>BUILD ALTERNATIVE</td><td></td></tr> </table>	North-South Street	East-West Street	NEW INTERSECTION		BUILD ALTERNATIVE				<table border="1"> <tr><td>11</td><td>Berkeley Ave</td></tr> <tr><td>2020</td><td>Berkeley Interchange Ramp</td></tr> <tr><td>215</td><td>280</td></tr> <tr><td>455</td><td>175</td></tr> <tr><td>220</td><td>150</td></tr> <tr><td>110</td><td>65</td></tr> <tr><td>45</td><td>45</td></tr> <tr><td>760</td><td>0</td></tr> <tr><td>45</td><td>0</td></tr> <tr><td>195</td><td>0</td></tr> <tr><td>325</td><td>0</td></tr> <tr><td>0</td><td>0</td></tr> <tr><td>0</td><td>0</td></tr> <tr><td>0</td><td>0</td></tr> </table>	11	Berkeley Ave	2020	Berkeley Interchange Ramp	215	280	455	175	220	150	110	65	45	45	760	0	45	0	195	0	325	0	0	0	0	0	0	0																																																																												
North-South Street	East-West Street																																																																																																																
NEW INTERSECTION																																																																																																																	
BUILD ALTERNATIVE																																																																																																																	
11	Berkeley Ave																																																																																																																
2020	Berkeley Interchange Ramp																																																																																																																
215	280																																																																																																																
455	175																																																																																																																
220	150																																																																																																																
110	65																																																																																																																
45	45																																																																																																																
760	0																																																																																																																
45	0																																																																																																																
195	0																																																																																																																
325	0																																																																																																																
0	0																																																																																																																
0	0																																																																																																																
0	0																																																																																																																
<table border="1"> <tr><td>North-South Street</td><td>East-West Street</td></tr> <tr><td>TRUCK DATA NOT AVAILABLE</td><td></td></tr> </table>	North-South Street	East-West Street	TRUCK DATA NOT AVAILABLE		<table border="1"> <tr><td>11</td><td>Berkeley St</td></tr> <tr><td>2020</td><td>Washington Ave</td></tr> <tr><td>5</td><td>0</td></tr> <tr><td>5</td><td>0</td></tr> <tr><td>5</td><td>5</td></tr> <tr><td>5</td><td>5</td></tr> <tr><td>95</td><td>0</td></tr> <tr><td>270</td><td>65</td></tr> <tr><td>0</td><td>0</td></tr> <tr><td>375</td><td>60</td></tr> <tr><td>0</td><td>5</td></tr> <tr><td>30</td><td>255</td></tr> <tr><td>0</td><td>5</td></tr> <tr><td>0</td><td>35</td></tr> <tr><td>0</td><td>20</td></tr> </table>	11	Berkeley St	2020	Washington Ave	5	0	5	0	5	5	5	5	95	0	270	65	0	0	375	60	0	5	30	255	0	5	0	35	0	20	<table border="1"> <tr><td>13</td><td>Berkeley St</td></tr> <tr><td>2020</td><td>Washington Ave</td></tr> <tr><td>5</td><td>0</td></tr> <tr><td>5</td><td>0</td></tr> <tr><td>5</td><td>5</td></tr> <tr><td>5</td><td>5</td></tr> <tr><td>125</td><td>0</td></tr> <tr><td>335</td><td>90</td></tr> <tr><td>0</td><td>0</td></tr> <tr><td>470</td><td>85</td></tr> <tr><td>0</td><td>5</td></tr> <tr><td>35</td><td>325</td></tr> <tr><td>0</td><td>5</td></tr> <tr><td>0</td><td>40</td></tr> <tr><td>0</td><td>15</td></tr> </table>	13	Berkeley St	2020	Washington Ave	5	0	5	0	5	5	5	5	125	0	335	90	0	0	470	85	0	5	35	325	0	5	0	40	0	15	<table border="1"> <tr><td>13</td><td>Berkeley St</td></tr> <tr><td>2020</td><td>Washington Ave</td></tr> <tr><td>0</td><td>0</td></tr> <tr><td>0</td><td>0</td></tr> <tr><td>0</td><td>0</td></tr> <tr><td>0</td><td>0</td></tr> <tr><td>220</td><td>0</td></tr> <tr><td>155</td><td>220</td></tr> <tr><td>0</td><td>0</td></tr> <tr><td>420</td><td>220</td></tr> <tr><td>0</td><td>0</td></tr> <tr><td>0</td><td>45</td></tr> <tr><td>0</td><td>0</td></tr> <tr><td>0</td><td>5</td></tr> <tr><td>0</td><td>0</td></tr> <tr><td>0</td><td>195</td></tr> </table>	13	Berkeley St	2020	Washington Ave	0	0	0	0	0	0	0	0	220	0	155	220	0	0	420	220	0	0	0	45	0	0	0	5	0	0	0	195														
North-South Street	East-West Street																																																																																																																
TRUCK DATA NOT AVAILABLE																																																																																																																	
11	Berkeley St																																																																																																																
2020	Washington Ave																																																																																																																
5	0																																																																																																																
5	0																																																																																																																
5	5																																																																																																																
5	5																																																																																																																
95	0																																																																																																																
270	65																																																																																																																
0	0																																																																																																																
375	60																																																																																																																
0	5																																																																																																																
30	255																																																																																																																
0	5																																																																																																																
0	35																																																																																																																
0	20																																																																																																																
13	Berkeley St																																																																																																																
2020	Washington Ave																																																																																																																
5	0																																																																																																																
5	0																																																																																																																
5	5																																																																																																																
5	5																																																																																																																
125	0																																																																																																																
335	90																																																																																																																
0	0																																																																																																																
470	85																																																																																																																
0	5																																																																																																																
35	325																																																																																																																
0	5																																																																																																																
0	40																																																																																																																
0	15																																																																																																																
13	Berkeley St																																																																																																																
2020	Washington Ave																																																																																																																
0	0																																																																																																																
0	0																																																																																																																
0	0																																																																																																																
0	0																																																																																																																
220	0																																																																																																																
155	220																																																																																																																
0	0																																																																																																																
420	220																																																																																																																
0	0																																																																																																																
0	45																																																																																																																
0	0																																																																																																																
0	5																																																																																																																
0	0																																																																																																																
0	195																																																																																																																
<table border="1"> <tr><td>North-South Street</td><td>East-West Street</td></tr> <tr><td>Count Date:</td><td>2/14/2013</td></tr> <tr><td>Count Source:</td><td>TC2</td></tr> <tr><td>EB</td><td>WB</td><td>NB</td><td>SB</td><td>Total</td></tr> <tr><td>%HV</td><td>2%</td><td>1%</td><td>1%</td><td>6%</td></tr> <tr><td>PHF</td><td colspan="4">0.82</td></tr> <tr><td>Peak Hour Used:</td><td colspan="4"></td></tr> <tr><td>From</td><td>715</td><td>To</td><td>815</td><td></td></tr> </table>	North-South Street	East-West Street	Count Date:	2/14/2013	Count Source:	TC2	EB	WB	NB	SB	Total	%HV	2%	1%	1%	6%	PHF	0.82				Peak Hour Used:					From	715	To	815		<table border="1"> <tr><td>11</td><td>Berkeley St</td></tr> <tr><td>2013</td><td>Union Ave</td></tr> <tr><td>15</td><td>5</td></tr> <tr><td>10</td><td>5</td></tr> <tr><td>10</td><td>0</td></tr> <tr><td>210</td><td>5</td></tr> <tr><td>405</td><td>220</td></tr> <tr><td>180</td><td>95</td></tr> <tr><td>195</td><td>10</td></tr> <tr><td>130</td><td>80</td></tr> <tr><td>5</td><td>180</td></tr> <tr><td>5</td><td>270</td></tr> <tr><td>45</td><td>10</td></tr> <tr><td>5</td><td>195</td></tr> </table>	11	Berkeley St	2013	Union Ave	15	5	10	5	10	0	210	5	405	220	180	95	195	10	130	80	5	180	5	270	45	10	5	195	<table border="1"> <tr><td>14</td><td>Berkeley St</td></tr> <tr><td>2020</td><td>Union Ave</td></tr> <tr><td>15</td><td>5</td></tr> <tr><td>10</td><td>5</td></tr> <tr><td>10</td><td>0</td></tr> <tr><td>225</td><td>5</td></tr> <tr><td>490</td><td>285</td></tr> <tr><td>165</td><td>125</td></tr> <tr><td>215</td><td>10</td></tr> <tr><td>115</td><td>110</td></tr> <tr><td>5</td><td>215</td></tr> <tr><td>5</td><td>215</td></tr> </table>	14	Berkeley St	2020	Union Ave	15	5	10	5	10	0	225	5	490	285	165	125	215	10	115	110	5	215	5	215	<table border="1"> <tr><td>14</td><td>Berkeley St</td></tr> <tr><td>2020</td><td>Union Ave</td></tr> <tr><td>20</td><td>5</td></tr> <tr><td>10</td><td>5</td></tr> <tr><td>10</td><td>0</td></tr> <tr><td>0</td><td>0</td></tr> <tr><td>0</td><td>0</td></tr> <tr><td>0</td><td>0</td></tr> <tr><td>155</td><td>220</td></tr> <tr><td>210</td><td>155</td></tr> <tr><td>150</td><td>205</td></tr> <tr><td>5</td><td>210</td></tr> <tr><td>5</td><td>210</td></tr> </table>	14	Berkeley St	2020	Union Ave	20	5	10	5	10	0	0	0	0	0	0	0	155	220	210	155	150	205	5	210	5	210	
North-South Street	East-West Street																																																																																																																
Count Date:	2/14/2013																																																																																																																
Count Source:	TC2																																																																																																																
EB	WB	NB	SB	Total																																																																																																													
%HV	2%	1%	1%	6%																																																																																																													
PHF	0.82																																																																																																																
Peak Hour Used:																																																																																																																	
From	715	To	815																																																																																																														
11	Berkeley St																																																																																																																
2013	Union Ave																																																																																																																
15	5																																																																																																																
10	5																																																																																																																
10	0																																																																																																																
210	5																																																																																																																
405	220																																																																																																																
180	95																																																																																																																
195	10																																																																																																																
130	80																																																																																																																
5	180																																																																																																																
5	270																																																																																																																
45	10																																																																																																																
5	195																																																																																																																
14	Berkeley St																																																																																																																
2020	Union Ave																																																																																																																
15	5																																																																																																																
10	5																																																																																																																
10	0																																																																																																																
225	5																																																																																																																
490	285																																																																																																																
165	125																																																																																																																
215	10																																																																																																																
115	110																																																																																																																
5	215																																																																																																																
5	215																																																																																																																
14	Berkeley St																																																																																																																
2020	Union Ave																																																																																																																
20	5																																																																																																																
10	5																																																																																																																
10	0																																																																																																																
0	0																																																																																																																
0	0																																																																																																																
0	0																																																																																																																
155	220																																																																																																																
210	155																																																																																																																
150	205																																																																																																																
5	210																																																																																																																
5	210																																																																																																																
<table border="1"> <tr><td>North-South Street</td><td>East-West Street</td></tr> <tr><td>Count Date:</td><td>2/14/2013</td></tr> <tr><td>Count Source:</td><td>TC2</td></tr> <tr><td>EB</td><td>WB</td><td>NB</td><td>SB</td><td>Total</td></tr> <tr><td>%HV</td><td>1%</td><td>1%</td><td>3%</td><td></td></tr> <tr><td>PHF</td><td colspan="4">0.86</td></tr> <tr><td>Peak Hour Used:</td><td colspan="4"></td></tr> <tr><td>From</td><td>715</td><td>To</td><td>815</td><td></td></tr> </table>	North-South Street	East-West Street	Count Date:	2/14/2013	Count Source:	TC2	EB	WB	NB	SB	Total	%HV	1%	1%	3%		PHF	0.86				Peak Hour Used:					From	715	To	815		<table border="1"> <tr><td>12</td><td>Berkeley St</td></tr> <tr><td>2013</td><td>SB I-5 Ramps</td></tr> <tr><td>200</td><td>80</td></tr> <tr><td>0</td><td>130</td></tr> <tr><td>0</td><td>0</td></tr> <tr><td>120</td><td>210</td></tr> <tr><td>380</td><td>400</td></tr> <tr><td>970</td><td>140</td></tr> <tr><td>0</td><td>0</td></tr> <tr><td>830</td><td>0</td></tr> <tr><td>0</td><td>0</td></tr> </table>	12	Berkeley St	2013	SB I-5 Ramps	200	80	0	130	0	0	120	210	380	400	970	140	0	0	830	0	0	0	<table border="1"> <tr><td>15</td><td>Berkeley St</td></tr> <tr><td>2020</td><td>SB I-5 Ramps</td></tr> <tr><td>185</td><td>0</td></tr> <tr><td>0</td><td>0</td></tr> <tr><td>0</td><td>0</td></tr> <tr><td>125</td><td>225</td></tr> <tr><td>405</td><td>490</td></tr> <tr><td>1,115</td><td>210</td></tr> <tr><td>0</td><td>0</td></tr> <tr><td>905</td><td>0</td></tr> <tr><td>0</td><td>0</td></tr> </table>	15	Berkeley St	2020	SB I-5 Ramps	185	0	0	0	0	0	125	225	405	490	1,115	210	0	0	905	0	0	0	<table border="1"> <tr><td>14</td><td>Berkeley Ave</td></tr> <tr><td>2020</td><td>SB I-5 Ramps</td></tr> <tr><td>195</td><td>0</td></tr> <tr><td>0</td><td>0</td></tr> <tr><td>0</td><td>0</td></tr> <tr><td>140</td><td>215</td></tr> <tr><td>410</td><td>455</td></tr> <tr><td>1,205</td><td>185</td></tr> <tr><td>0</td><td>0</td></tr> <tr><td>1,020</td><td>0</td></tr> <tr><td>0</td><td>0</td></tr> </table>	14	Berkeley Ave	2020	SB I-5 Ramps	195	0	0	0	0	0	140	215	410	455	1,205	185	0	0	1,020	0	0	0													
North-South Street	East-West Street																																																																																																																
Count Date:	2/14/2013																																																																																																																
Count Source:	TC2																																																																																																																
EB	WB	NB	SB	Total																																																																																																													
%HV	1%	1%	3%																																																																																																														
PHF	0.86																																																																																																																
Peak Hour Used:																																																																																																																	
From	715	To	815																																																																																																														
12	Berkeley St																																																																																																																
2013	SB I-5 Ramps																																																																																																																
200	80																																																																																																																
0	130																																																																																																																
0	0																																																																																																																
120	210																																																																																																																
380	400																																																																																																																
970	140																																																																																																																
0	0																																																																																																																
830	0																																																																																																																
0	0																																																																																																																
15	Berkeley St																																																																																																																
2020	SB I-5 Ramps																																																																																																																
185	0																																																																																																																
0	0																																																																																																																
0	0																																																																																																																
125	225																																																																																																																
405	490																																																																																																																
1,115	210																																																																																																																
0	0																																																																																																																
905	0																																																																																																																
0	0																																																																																																																
14	Berkeley Ave																																																																																																																
2020	SB I-5 Ramps																																																																																																																
195	0																																																																																																																
0	0																																																																																																																
0	0																																																																																																																
140	215																																																																																																																
410	455																																																																																																																
1,205	185																																																																																																																
0	0																																																																																																																
1,020	0																																																																																																																
0	0																																																																																																																
			<table border="1"> <tr><td>Berkeley St</td><td>Union Ave</td></tr> <tr><td>5</td><td>5</td></tr> <tr><td>5</td><td>5</td></tr> <tr><td>0</td><td>0</td></tr> <tr><td>245</td><td>140</td></tr> <tr><td>600</td><td>435</td></tr> <tr><td>170</td><td>45</td></tr> <tr><td>225</td><td>5</td></tr> <tr><td>120</td><td>120</td></tr> <tr><td>0</td><td>0</td></tr> </table>	Berkeley St	Union Ave	5	5	5	5	0	0	245	140	600	435	170	45	225	5	120	120	0	0																																																																																										
Berkeley St	Union Ave																																																																																																																
5	5																																																																																																																
5	5																																																																																																																
0	0																																																																																																																
245	140																																																																																																																
600	435																																																																																																																
170	45																																																																																																																
225	5																																																																																																																
120	120																																																																																																																
0	0																																																																																																																
			<table border="1"> <tr><td>Berkeley St</td><td>SB I-5 Ramps</td></tr> <tr><td>0</td><td>0</td></tr> <tr><td>0</td><td>0</td></tr> <tr><td>0</td><td>0</td></tr> <tr><td>120</td><td>245</td></tr> <tr><td>485</td><td>600</td></tr> <tr><td>1,060</td><td>235</td></tr> <tr><td>0</td><td>0</td></tr> <tr><td>825</td><td>0</td></tr> <tr><td>0</td><td>0</td></tr> </table>	Berkeley St	SB I-5 Ramps	0	0	0	0	0	0	120	245	485	600	1,060	235	0	0	825	0	0	0																																																																																										
Berkeley St	SB I-5 Ramps																																																																																																																
0	0																																																																																																																
0	0																																																																																																																
0	0																																																																																																																
120	245																																																																																																																
485	600																																																																																																																
1,060	235																																																																																																																
0	0																																																																																																																
825	0																																																																																																																
0	0																																																																																																																
			<table border="1"> <tr><td>Berkeley Ave</td><td>SB I-5 Ramps</td></tr> <tr><td>225</td><td>0</td></tr> <tr><td>0</td><td>0</td></tr> <tr><td>0</td><td>0</td></tr> <tr><td>140</td><td>270</td></tr> <tr><td>435</td><td>530</td></tr> <tr><td>1,290</td><td>235</td></tr> <tr><td>0</td><td>0</td></tr> <tr><td>1,055</td><td>0</td></tr> <tr><td>0</td><td>0</td></tr> </table>	Berkeley Ave	SB I-5 Ramps	225	0	0	0	0	0	140	270	435	530	1,290	235	0	0	1,055	0	0	0																																																																																										
Berkeley Ave	SB I-5 Ramps																																																																																																																
225	0																																																																																																																
0	0																																																																																																																
0	0																																																																																																																
140	270																																																																																																																
435	530																																																																																																																
1,290	235																																																																																																																
0	0																																																																																																																
1,055	0																																																																																																																
0	0																																																																																																																

AM PEAK HOUR TURNING MOVEMENT SUMMARY

Post-processed Data
from Mesoscopic Model

	Post-Processed EXISTING 2013 Model Volumes Peak Hour	Post-Processed NO BUILD P1 2020 Volumes Peak Hour	Post-Processed BUILD RB_sbGLC_noHOV_2020 Volumes Peak Hour	Post-Processed NO BUILD P1 2040 Volumes Peak Hour	Post-Processed BUILD RB_sbGLC_noHOV_2040 Volume Peak Hour																																																																																																																																																																																																																																																																																																						
<table border="1"> <tr><th colspan="2">North-South Street</th><th colspan="2">Berkeley St</th></tr> <tr><th colspan="2">East-West Street</th><th colspan="2">NB I-5 Ramps</th></tr> <tr><td colspan="2">Count Date: 2/14/2013</td><td colspan="2">2013</td></tr> <tr><td colspan="2">Count Source: TC2</td><td colspan="2"></td></tr> <tr><td>EB</td><td>WB</td><td>NB</td><td>SB</td><td>Total</td><td colspan="2"></td></tr> <tr><td>1%</td><td></td><td>3%</td><td>2%</td><td></td><td colspan="2"></td></tr> <tr><td colspan="4">PHF</td><td>0.93</td><td colspan="2"></td></tr> <tr><td colspan="6">Peak Hour Used:</td></tr> <tr><td colspan="2">From 715</td><td colspan="2">To 815</td><td colspan="2"></td></tr> </table>	North-South Street		Berkeley St		East-West Street		NB I-5 Ramps		Count Date: 2/14/2013		2013		Count Source: TC2				EB	WB	NB	SB	Total			1%		3%	2%				PHF				0.93			Peak Hour Used:						From 715		To 815				<table border="1"> <tr><th colspan="2">North-South Street</th><th colspan="2">Berkeley St</th></tr> <tr><th colspan="2">East-West Street</th><th colspan="2">NB I-5 Ramps</th></tr> <tr><td colspan="2">Count Date: 2/14/2013</td><td colspan="2">2013</td></tr> <tr><td colspan="2">Count Source: TC2</td><td colspan="2"></td></tr> <tr><td>EB</td><td>WB</td><td>NB</td><td>SB</td><td>Total</td><td colspan="2"></td></tr> <tr><td>1%</td><td></td><td>3%</td><td>2%</td><td></td><td colspan="2"></td></tr> <tr><td colspan="4">PHF</td><td>0.93</td><td colspan="2"></td></tr> <tr><td colspan="6">Peak Hour Used:</td></tr> <tr><td colspan="2">From 715</td><td colspan="2">To 815</td><td colspan="2"></td></tr> </table>	North-South Street		Berkeley St		East-West Street		NB I-5 Ramps		Count Date: 2/14/2013		2013		Count Source: TC2				EB	WB	NB	SB	Total			1%		3%	2%				PHF				0.93			Peak Hour Used:						From 715		To 815				<table border="1"> <tr><th colspan="2">North-South Street</th><th colspan="2">Berkeley St</th></tr> <tr><th colspan="2">East-West Street</th><th colspan="2">NB I-5 Ramps</th></tr> <tr><td colspan="2">Count Date: 2/14/2013</td><td colspan="2">2013</td></tr> <tr><td colspan="2">Count Source: TC2</td><td colspan="2"></td></tr> <tr><td>EB</td><td>WB</td><td>NB</td><td>SB</td><td>Total</td><td colspan="2"></td></tr> <tr><td>1%</td><td></td><td>3%</td><td>2%</td><td></td><td colspan="2"></td></tr> <tr><td colspan="4">PHF</td><td>0.93</td><td colspan="2"></td></tr> <tr><td colspan="6">Peak Hour Used:</td></tr> <tr><td colspan="2">From 715</td><td colspan="2">To 815</td><td colspan="2"></td></tr> </table>	North-South Street		Berkeley St		East-West Street		NB I-5 Ramps		Count Date: 2/14/2013		2013		Count Source: TC2				EB	WB	NB	SB	Total			1%		3%	2%				PHF				0.93			Peak Hour Used:						From 715		To 815				<table border="1"> <tr><th colspan="2">North-South Street</th><th colspan="2">Berkeley Ave</th></tr> <tr><th colspan="2">East-West Street</th><th colspan="2">NB I-5 Ramps</th></tr> <tr><td colspan="2">Count Date: 2/14/2013</td><td colspan="2">2013</td></tr> <tr><td colspan="2">Count Source: TC2</td><td colspan="2"></td></tr> <tr><td>EB</td><td>WB</td><td>NB</td><td>SB</td><td>Total</td><td colspan="2"></td></tr> <tr><td>1%</td><td></td><td>3%</td><td>2%</td><td></td><td colspan="2"></td></tr> <tr><td colspan="4">PHF</td><td>0.93</td><td colspan="2"></td></tr> <tr><td colspan="6">Peak Hour Used:</td></tr> <tr><td colspan="2">From 715</td><td colspan="2">To 815</td><td colspan="2"></td></tr> </table>	North-South Street		Berkeley Ave		East-West Street		NB I-5 Ramps		Count Date: 2/14/2013		2013		Count Source: TC2				EB	WB	NB	SB	Total			1%		3%	2%				PHF				0.93			Peak Hour Used:						From 715		To 815				<table border="1"> <tr><th colspan="2">North-South Street</th><th colspan="2">Berkeley Ave</th></tr> <tr><th colspan="2">East-West Street</th><th colspan="2">NB I-5 Ramps</th></tr> <tr><td colspan="2">Count Date: 2/14/2013</td><td colspan="2">2013</td></tr> <tr><td colspan="2">Count Source: TC2</td><td colspan="2"></td></tr> <tr><td>EB</td><td>WB</td><td>NB</td><td>SB</td><td>Total</td><td colspan="2"></td></tr> <tr><td>1%</td><td></td><td>3%</td><td>2%</td><td></td><td colspan="2"></td></tr> <tr><td colspan="4">PHF</td><td>0.93</td><td colspan="2"></td></tr> <tr><td colspan="6">Peak Hour Used:</td></tr> <tr><td colspan="2">From 715</td><td colspan="2">To 815</td><td colspan="2"></td></tr> </table>	North-South Street		Berkeley Ave		East-West Street		NB I-5 Ramps		Count Date: 2/14/2013		2013		Count Source: TC2				EB	WB	NB	SB	Total			1%		3%	2%				PHF				0.93			Peak Hour Used:						From 715		To 815				<table border="1"> <tr><th colspan="2">North-South Street</th><th colspan="2">Berkeley Ave</th></tr> <tr><th colspan="2">East-West Street</th><th colspan="2">NB I-5 Ramps</th></tr> <tr><td colspan="2">Count Date: 2/14/2013</td><td colspan="2">2013</td></tr> <tr><td colspan="2">Count Source: TC2</td><td colspan="2"></td></tr> <tr><td>EB</td><td>WB</td><td>NB</td><td>SB</td><td>Total</td><td colspan="2"></td></tr> <tr><td>1%</td><td></td><td>3%</td><td>2%</td><td></td><td colspan="2"></td></tr> <tr><td colspan="4">PHF</td><td>0.93</td><td colspan="2"></td></tr> <tr><td colspan="6">Peak Hour Used:</td></tr> <tr><td colspan="2">From 715</td><td colspan="2">To 815</td><td colspan="2"></td></tr> </table>	North-South Street		Berkeley Ave		East-West Street		NB I-5 Ramps		Count Date: 2/14/2013		2013		Count Source: TC2				EB	WB	NB	SB	Total			1%		3%	2%				PHF				0.93			Peak Hour Used:						From 715		To 815			
North-South Street		Berkeley St																																																																																																																																																																																																																																																																																																									
East-West Street		NB I-5 Ramps																																																																																																																																																																																																																																																																																																									
Count Date: 2/14/2013		2013																																																																																																																																																																																																																																																																																																									
Count Source: TC2																																																																																																																																																																																																																																																																																																											
EB	WB	NB	SB	Total																																																																																																																																																																																																																																																																																																							
1%		3%	2%																																																																																																																																																																																																																																																																																																								
PHF				0.93																																																																																																																																																																																																																																																																																																							
Peak Hour Used:																																																																																																																																																																																																																																																																																																											
From 715		To 815																																																																																																																																																																																																																																																																																																									
North-South Street		Berkeley St																																																																																																																																																																																																																																																																																																									
East-West Street		NB I-5 Ramps																																																																																																																																																																																																																																																																																																									
Count Date: 2/14/2013		2013																																																																																																																																																																																																																																																																																																									
Count Source: TC2																																																																																																																																																																																																																																																																																																											
EB	WB	NB	SB	Total																																																																																																																																																																																																																																																																																																							
1%		3%	2%																																																																																																																																																																																																																																																																																																								
PHF				0.93																																																																																																																																																																																																																																																																																																							
Peak Hour Used:																																																																																																																																																																																																																																																																																																											
From 715		To 815																																																																																																																																																																																																																																																																																																									
North-South Street		Berkeley St																																																																																																																																																																																																																																																																																																									
East-West Street		NB I-5 Ramps																																																																																																																																																																																																																																																																																																									
Count Date: 2/14/2013		2013																																																																																																																																																																																																																																																																																																									
Count Source: TC2																																																																																																																																																																																																																																																																																																											
EB	WB	NB	SB	Total																																																																																																																																																																																																																																																																																																							
1%		3%	2%																																																																																																																																																																																																																																																																																																								
PHF				0.93																																																																																																																																																																																																																																																																																																							
Peak Hour Used:																																																																																																																																																																																																																																																																																																											
From 715		To 815																																																																																																																																																																																																																																																																																																									
North-South Street		Berkeley Ave																																																																																																																																																																																																																																																																																																									
East-West Street		NB I-5 Ramps																																																																																																																																																																																																																																																																																																									
Count Date: 2/14/2013		2013																																																																																																																																																																																																																																																																																																									
Count Source: TC2																																																																																																																																																																																																																																																																																																											
EB	WB	NB	SB	Total																																																																																																																																																																																																																																																																																																							
1%		3%	2%																																																																																																																																																																																																																																																																																																								
PHF				0.93																																																																																																																																																																																																																																																																																																							
Peak Hour Used:																																																																																																																																																																																																																																																																																																											
From 715		To 815																																																																																																																																																																																																																																																																																																									
North-South Street		Berkeley Ave																																																																																																																																																																																																																																																																																																									
East-West Street		NB I-5 Ramps																																																																																																																																																																																																																																																																																																									
Count Date: 2/14/2013		2013																																																																																																																																																																																																																																																																																																									
Count Source: TC2																																																																																																																																																																																																																																																																																																											
EB	WB	NB	SB	Total																																																																																																																																																																																																																																																																																																							
1%		3%	2%																																																																																																																																																																																																																																																																																																								
PHF				0.93																																																																																																																																																																																																																																																																																																							
Peak Hour Used:																																																																																																																																																																																																																																																																																																											
From 715		To 815																																																																																																																																																																																																																																																																																																									
North-South Street		Berkeley Ave																																																																																																																																																																																																																																																																																																									
East-West Street		NB I-5 Ramps																																																																																																																																																																																																																																																																																																									
Count Date: 2/14/2013		2013																																																																																																																																																																																																																																																																																																									
Count Source: TC2																																																																																																																																																																																																																																																																																																											
EB	WB	NB	SB	Total																																																																																																																																																																																																																																																																																																							
1%		3%	2%																																																																																																																																																																																																																																																																																																								
PHF				0.93																																																																																																																																																																																																																																																																																																							
Peak Hour Used:																																																																																																																																																																																																																																																																																																											
From 715		To 815																																																																																																																																																																																																																																																																																																									
NEW INTERSECTION BUILD ALTERNATIVE																																																																																																																																																																																																																																																																																																											
<table border="1"> <tr><th colspan="2">North-South Street</th><th colspan="2">Thorne Ln</th></tr> <tr><th colspan="2">East-West Street</th><th colspan="2">Union Ave</th></tr> <tr><td colspan="2">Count Date: 3/5/2013</td><td colspan="2">2014</td></tr> <tr><td colspan="2">Count Source: TC2</td><td colspan="2"></td></tr> <tr><td>EB</td><td>WB</td><td>NB</td><td>SB</td><td>Total</td><td colspan="2"></td></tr> <tr><td>7%</td><td></td><td>3%</td><td>0%</td><td></td><td colspan="2"></td></tr> <tr><td colspan="4">PHF</td><td>0.80</td><td colspan="2"></td></tr> <tr><td colspan="6">Peak Hour Used:</td></tr> <tr><td colspan="2">From 715</td><td colspan="2">To 815</td><td colspan="2"></td></tr> </table>	North-South Street		Thorne Ln		East-West Street		Union Ave		Count Date: 3/5/2013		2014		Count Source: TC2				EB	WB	NB	SB	Total			7%		3%	0%				PHF				0.80			Peak Hour Used:						From 715		To 815				<table border="1"> <tr><th colspan="2">North-South Street</th><th colspan="2">Thorne Ln</th></tr> <tr><th colspan="2">East-West Street</th><th colspan="2">SB I-5 Ramps</th></tr> <tr><td colspan="2">Count Date: 3/5/2013</td><td colspan="2">2014</td></tr> <tr><td colspan="2">Count Source: TC2</td><td colspan="2"></td></tr> <tr><td>EB</td><td>WB</td><td>NB</td><td>SB</td><td>Total</td><td colspan="2"></td></tr> <tr><td>5%</td><td></td><td>6%</td><td>5%</td><td></td><td colspan="2"></td></tr> <tr><td colspan="4">PHF</td><td>0.87</td><td colspan="2"></td></tr> <tr><td colspan="6">Peak Hour Used:</td></tr> <tr><td colspan="2">From 715</td><td colspan="2">To 815</td><td colspan="2"></td></tr> </table>	North-South Street		Thorne Ln		East-West Street		SB I-5 Ramps		Count Date: 3/5/2013		2014		Count Source: TC2				EB	WB	NB	SB	Total			5%		6%	5%				PHF				0.87			Peak Hour Used:						From 715		To 815				<table border="1"> <tr><th colspan="2">North-South Street</th><th colspan="2">Thorne Ln</th></tr> <tr><th colspan="2">East-West Street</th><th colspan="2">SB I-5 Ramps</th></tr> <tr><td colspan="2">Count Date: 3/5/2013</td><td colspan="2">2014</td></tr> <tr><td colspan="2">Count Source: TC2</td><td colspan="2"></td></tr> <tr><td>EB</td><td>WB</td><td>NB</td><td>SB</td><td>Total</td><td colspan="2"></td></tr> <tr><td>5%</td><td></td><td>6%</td><td>5%</td><td></td><td colspan="2"></td></tr> <tr><td colspan="4">PHF</td><td>0.87</td><td colspan="2"></td></tr> <tr><td colspan="6">Peak Hour Used:</td></tr> <tr><td colspan="2">From 715</td><td colspan="2">To 815</td><td colspan="2"></td></tr> </table>	North-South Street		Thorne Ln		East-West Street		SB I-5 Ramps		Count Date: 3/5/2013		2014		Count Source: TC2				EB	WB	NB	SB	Total			5%		6%	5%				PHF				0.87			Peak Hour Used:						From 715		To 815				<table border="1"> <tr><th colspan="2">North-South Street</th><th colspan="2">Thorne Ln</th></tr> <tr><th colspan="2">East-West Street</th><th colspan="2">Gravelly-Thorne Connector Ln</th></tr> <tr><td colspan="2">Count Date: 3/5/2013</td><td colspan="2">2020</td></tr> <tr><td colspan="2">Count Source: TC2</td><td colspan="2"></td></tr> <tr><td>EB</td><td>WB</td><td>NB</td><td>SB</td><td>Total</td><td colspan="2"></td></tr> <tr><td>7%</td><td></td><td>3%</td><td>0%</td><td></td><td colspan="2"></td></tr> <tr><td colspan="4">PHF</td><td>0.80</td><td colspan="2"></td></tr> <tr><td colspan="6">Peak Hour Used:</td></tr> <tr><td colspan="2">From 715</td><td colspan="2">To 815</td><td colspan="2"></td></tr> </table>	North-South Street		Thorne Ln		East-West Street		Gravelly-Thorne Connector Ln		Count Date: 3/5/2013		2020		Count Source: TC2				EB	WB	NB	SB	Total			7%		3%	0%				PHF				0.80			Peak Hour Used:						From 715		To 815				<table border="1"> <tr><th colspan="2">North-South Street</th><th colspan="2">Thorne Ln</th></tr> <tr><th colspan="2">East-West Street</th><th colspan="2">Union Ave</th></tr> <tr><td colspan="2">Count Date: 3/5/2013</td><td colspan="2">2020</td></tr> <tr><td colspan="2">Count Source: TC2</td><td colspan="2"></td></tr> <tr><td>EB</td><td>WB</td><td>NB</td><td>SB</td><td>Total</td><td colspan="2"></td></tr> <tr><td>7%</td><td></td><td>3%</td><td>0%</td><td></td><td colspan="2"></td></tr> <tr><td colspan="4">PHF</td><td>0.80</td><td colspan="2"></td></tr> <tr><td colspan="6">Peak Hour Used:</td></tr> <tr><td colspan="2">From 715</td><td colspan="2">To 815</td><td colspan="2"></td></tr> </table>	North-South Street		Thorne Ln		East-West Street		Union Ave		Count Date: 3/5/2013		2020		Count Source: TC2				EB	WB	NB	SB	Total			7%		3%	0%				PHF				0.80			Peak Hour Used:						From 715		To 815				<table border="1"> <tr><th colspan="2">North-South Street</th><th colspan="2">Thorne Ln</th></tr> <tr><th colspan="2">East-West Street</th><th colspan="2">Gravelly-Thorne Connector Ln</th></tr> <tr><td colspan="2">Count Date: 3/5/2013</td><td colspan="2">2020</td></tr> <tr><td colspan="2">Count Source: TC2</td><td colspan="2"></td></tr> <tr><td>EB</td><td>WB</td><td>NB</td><td>SB</td><td>Total</td><td colspan="2"></td></tr> <tr><td>7%</td><td></td><td>3%</td><td>0%</td><td></td><td colspan="2"></td></tr> <tr><td colspan="4">PHF</td><td>0.80</td><td colspan="2"></td></tr> <tr><td colspan="6">Peak Hour Used:</td></tr> <tr><td colspan="2">From 715</td><td colspan="2">To 815</td><td colspan="2"></td></tr> </table>	North-South Street		Thorne Ln		East-West Street		Gravelly-Thorne Connector Ln		Count Date: 3/5/2013		2020		Count Source: TC2				EB	WB	NB	SB	Total			7%		3%	0%				PHF				0.80			Peak Hour Used:						From 715		To 815			
North-South Street		Thorne Ln																																																																																																																																																																																																																																																																																																									
East-West Street		Union Ave																																																																																																																																																																																																																																																																																																									
Count Date: 3/5/2013		2014																																																																																																																																																																																																																																																																																																									
Count Source: TC2																																																																																																																																																																																																																																																																																																											
EB	WB	NB	SB	Total																																																																																																																																																																																																																																																																																																							
7%		3%	0%																																																																																																																																																																																																																																																																																																								
PHF				0.80																																																																																																																																																																																																																																																																																																							
Peak Hour Used:																																																																																																																																																																																																																																																																																																											
From 715		To 815																																																																																																																																																																																																																																																																																																									
North-South Street		Thorne Ln																																																																																																																																																																																																																																																																																																									
East-West Street		SB I-5 Ramps																																																																																																																																																																																																																																																																																																									
Count Date: 3/5/2013		2014																																																																																																																																																																																																																																																																																																									
Count Source: TC2																																																																																																																																																																																																																																																																																																											
EB	WB	NB	SB	Total																																																																																																																																																																																																																																																																																																							
5%		6%	5%																																																																																																																																																																																																																																																																																																								
PHF				0.87																																																																																																																																																																																																																																																																																																							
Peak Hour Used:																																																																																																																																																																																																																																																																																																											
From 715		To 815																																																																																																																																																																																																																																																																																																									
North-South Street		Thorne Ln																																																																																																																																																																																																																																																																																																									
East-West Street		SB I-5 Ramps																																																																																																																																																																																																																																																																																																									
Count Date: 3/5/2013		2014																																																																																																																																																																																																																																																																																																									
Count Source: TC2																																																																																																																																																																																																																																																																																																											
EB	WB	NB	SB	Total																																																																																																																																																																																																																																																																																																							
5%		6%	5%																																																																																																																																																																																																																																																																																																								
PHF				0.87																																																																																																																																																																																																																																																																																																							
Peak Hour Used:																																																																																																																																																																																																																																																																																																											
From 715		To 815																																																																																																																																																																																																																																																																																																									
North-South Street		Thorne Ln																																																																																																																																																																																																																																																																																																									
East-West Street		Gravelly-Thorne Connector Ln																																																																																																																																																																																																																																																																																																									
Count Date: 3/5/2013		2020																																																																																																																																																																																																																																																																																																									
Count Source: TC2																																																																																																																																																																																																																																																																																																											
EB	WB	NB	SB	Total																																																																																																																																																																																																																																																																																																							
7%		3%	0%																																																																																																																																																																																																																																																																																																								
PHF				0.80																																																																																																																																																																																																																																																																																																							
Peak Hour Used:																																																																																																																																																																																																																																																																																																											
From 715		To 815																																																																																																																																																																																																																																																																																																									
North-South Street		Thorne Ln																																																																																																																																																																																																																																																																																																									
East-West Street		Union Ave																																																																																																																																																																																																																																																																																																									
Count Date: 3/5/2013		2020																																																																																																																																																																																																																																																																																																									
Count Source: TC2																																																																																																																																																																																																																																																																																																											
EB	WB	NB	SB	Total																																																																																																																																																																																																																																																																																																							
7%		3%	0%																																																																																																																																																																																																																																																																																																								
PHF				0.80																																																																																																																																																																																																																																																																																																							
Peak Hour Used:																																																																																																																																																																																																																																																																																																											
From 715		To 815																																																																																																																																																																																																																																																																																																									
North-South Street		Thorne Ln																																																																																																																																																																																																																																																																																																									
East-West Street		Gravelly-Thorne Connector Ln																																																																																																																																																																																																																																																																																																									
Count Date: 3/5/2013		2020																																																																																																																																																																																																																																																																																																									
Count Source: TC2																																																																																																																																																																																																																																																																																																											
EB	WB	NB	SB	Total																																																																																																																																																																																																																																																																																																							
7%		3%	0%																																																																																																																																																																																																																																																																																																								
PHF				0.80																																																																																																																																																																																																																																																																																																							
Peak Hour Used:																																																																																																																																																																																																																																																																																																											
From 715		To 815																																																																																																																																																																																																																																																																																																									
<table border="1"> <tr><th colspan="2">North-South Street</th><th colspan="2">Thorne Ln</th></tr> <tr><th colspan="2">East-West Street</th><th colspan="2">Union Ave</th></tr> <tr><td colspan="2">Count Date: 3/5/2013</td><td colspan="2">2020</td></tr> <tr><td colspan="2">Count Source: TC2</td><td colspan="2"></td></tr> <tr><td>EB</td><td>WB</td><td>NB</td><td>SB</td><td>Total</td><td colspan="2"></td></tr> <tr><td>7%</td><td></td><td>3%</td><td>0%</td><td></td><td colspan="2"></td></tr> <tr><td colspan="4">PHF</td><td>0.80</td><td colspan="2"></td></tr> <tr><td colspan="6">Peak Hour Used:</td></tr> <tr><td colspan="2">From 715</td><td colspan="2">To 815</td><td colspan="2"></td></tr> </table>	North-South Street		Thorne Ln		East-West Street		Union Ave		Count Date: 3/5/2013		2020		Count Source: TC2				EB	WB	NB	SB	Total			7%		3%	0%				PHF				0.80			Peak Hour Used:						From 715		To 815				<table border="1"> <tr><th colspan="2">North-South Street</th><th colspan="2">Thorne Ln</th></tr> <tr><th colspan="2">East-West Street</th><th colspan="2">SB I-5 Ramps</th></tr> <tr><td colspan="2">Count Date: 3/5/2013</td><td colspan="2">2020</td></tr> <tr><td colspan="2">Count Source: TC2</td><td colspan="2"></td></tr> <tr><td>EB</td><td>WB</td><td>NB</td><td>SB</td><td>Total</td><td colspan="2"></td></tr> <tr><td>5%</td><td></td><td>6%</td><td>5%</td><td></td><td colspan="2"></td></tr> <tr><td colspan="4">PHF</td><td>0.87</td><td colspan="2"></td></tr> <tr><td colspan="6">Peak Hour Used:</td></tr> <tr><td colspan="2">From 715</td><td colspan="2">To 815</td><td colspan="2"></td></tr> </table>	North-South Street		Thorne Ln		East-West Street		SB I-5 Ramps		Count Date: 3/5/2013		2020		Count Source: TC2				EB	WB	NB	SB	Total			5%		6%	5%				PHF				0.87			Peak Hour Used:						From 715		To 815				<table border="1"> <tr><th colspan="2">North-South Street</th><th colspan="2">Thorne Ln</th></tr> <tr><th colspan="2">East-West Street</th><th colspan="2">SB I-5 Ramps</th></tr> <tr><td colspan="2">Count Date: 3/5/2013</td><td colspan="2">2020</td></tr> <tr><td colspan="2">Count Source: TC2</td><td colspan="2"></td></tr> <tr><td>EB</td><td>WB</td><td>NB</td><td>SB</td><td>Total</td><td colspan="2"></td></tr> <tr><td>5%</td><td></td><td>6%</td><td>5%</td><td></td><td colspan="2"></td></tr> <tr><td colspan="4">PHF</td><td>0.87</td><td colspan="2"></td></tr> <tr><td colspan="6">Peak Hour Used:</td></tr> <tr><td colspan="2">From 715</td><td colspan="2">To 815</td><td colspan="2"></td></tr> </table>	North-South Street		Thorne Ln		East-West Street		SB I-5 Ramps		Count Date: 3/5/2013		2020		Count Source: TC2				EB	WB	NB	SB	Total			5%		6%	5%				PHF				0.87			Peak Hour Used:						From 715		To 815				<table border="1"> <tr><th colspan="2">North-South Street</th><th colspan="2">Thorne Ln</th></tr> <tr><th colspan="2">East-West Street</th><th colspan="2">Gravelly-Thorne Connector Ln</th></tr> <tr><td colspan="2">Count Date: 3/5/2013</td><td colspan="2">2020</td></tr> <tr><td colspan="2">Count Source: TC2</td><td colspan="2"></td></tr> <tr><td>EB</td><td>WB</td><td>NB</td><td>SB</td><td>Total</td><td colspan="2"></td></tr> <tr><td>7%</td><td></td><td>3%</td><td>0%</td><td></td><td colspan="2"></td></tr> <tr><td colspan="4">PHF</td><td>0.80</td><td colspan="2"></td></tr> <tr><td colspan="6">Peak Hour Used:</td></tr> <tr><td colspan="2">From 715</td><td colspan="2">To 815</td><td colspan="2"></td></tr> </table>	North-South Street		Thorne Ln		East-West Street		Gravelly-Thorne Connector Ln		Count Date: 3/5/2013		2020		Count Source: TC2				EB	WB	NB	SB	Total			7%		3%	0%				PHF				0.80			Peak Hour Used:						From 715		To 815				<table border="1"> <tr><th colspan="2">North-South Street</th><th colspan="2">Thorne Ln</th></tr> <tr><th colspan="2">East-West Street</th><th colspan="2">Union Ave</th></tr> <tr><td colspan="2">Count Date: 3/5/2013</td><td colspan="2">2020</td></tr> <tr><td colspan="2">Count Source: TC2</td><td colspan="2"></td></tr> <tr><td>EB</td><td>WB</td><td>NB</td><td>SB</td><td>Total</td><td colspan="2"></td></tr> <tr><td>7%</td><td></td><td>3%</td><td>0%</td><td></td><td colspan="2"></td></tr> <tr><td colspan="4">PHF</td><td>0.80</td><td colspan="2"></td></tr> <tr><td colspan="6">Peak Hour Used:</td></tr> <tr><td colspan="2">From 715</td><td colspan="2">To 815</td><td colspan="2"></td></tr> </table>	North-South Street		Thorne Ln		East-West Street		Union Ave		Count Date: 3/5/2013		2020		Count Source: TC2				EB	WB	NB	SB	Total			7%		3%	0%				PHF				0.80			Peak Hour Used:						From 715		To 815				<table border="1"> <tr><th colspan="2">North-South Street</th><th colspan="2">Thorne Ln</th></tr> <tr><th colspan="2">East-West Street</th><th colspan="2">Gravelly-Thorne Connector Ln</th></tr> <tr><td colspan="2">Count Date: 3/5/2013</td><td colspan="2">2020</td></tr> <tr><td colspan="2">Count Source: TC2</td><td colspan="2"></td></tr> <tr><td>EB</td><td>WB</td><td>NB</td><td>SB</td><td>Total</td><td colspan="2"></td></tr> <tr><td>7%</td><td></td><td>3%</td><td>0%</td><td></td><td colspan="2"></td></tr> <tr><td colspan="4">PHF</td><td>0.80</td><td colspan="2"></td></tr> <tr><td colspan="6">Peak Hour Used:</td></tr> <tr><td colspan="2">From 715</td><td colspan="2">To 815</td><td colspan="2"></td></tr> </table>	North-South Street		Thorne Ln		East-West Street		Gravelly-Thorne Connector Ln		Count Date: 3/5/2013		2020		Count Source: TC2				EB	WB	NB	SB	Total			7%		3%	0%				PHF				0.80			Peak Hour Used:						From 715		To 815			
North-South Street		Thorne Ln																																																																																																																																																																																																																																																																																																									
East-West Street		Union Ave																																																																																																																																																																																																																																																																																																									
Count Date: 3/5/2013		2020																																																																																																																																																																																																																																																																																																									
Count Source: TC2																																																																																																																																																																																																																																																																																																											
EB	WB	NB	SB	Total																																																																																																																																																																																																																																																																																																							
7%		3%	0%																																																																																																																																																																																																																																																																																																								
PHF				0.80																																																																																																																																																																																																																																																																																																							
Peak Hour Used:																																																																																																																																																																																																																																																																																																											
From 715		To 815																																																																																																																																																																																																																																																																																																									
North-South Street		Thorne Ln																																																																																																																																																																																																																																																																																																									
East-West Street		SB I-5 Ramps																																																																																																																																																																																																																																																																																																									
Count Date: 3/5/2013		2020																																																																																																																																																																																																																																																																																																									
Count Source: TC2																																																																																																																																																																																																																																																																																																											
EB	WB	NB	SB	Total																																																																																																																																																																																																																																																																																																							
5%		6%	5%																																																																																																																																																																																																																																																																																																								
PHF				0.87																																																																																																																																																																																																																																																																																																							
Peak Hour Used:																																																																																																																																																																																																																																																																																																											
From 715		To 815																																																																																																																																																																																																																																																																																																									
North-South Street		Thorne Ln																																																																																																																																																																																																																																																																																																									
East-West Street		SB I-5 Ramps																																																																																																																																																																																																																																																																																																									
Count Date: 3/5/2013		2020																																																																																																																																																																																																																																																																																																									
Count Source: TC2																																																																																																																																																																																																																																																																																																											
EB	WB	NB	SB	Total																																																																																																																																																																																																																																																																																																							
5%		6%	5%																																																																																																																																																																																																																																																																																																								
PHF				0.87																																																																																																																																																																																																																																																																																																							
Peak Hour Used:																																																																																																																																																																																																																																																																																																											
From 715		To 815																																																																																																																																																																																																																																																																																																									
North-South Street		Thorne Ln																																																																																																																																																																																																																																																																																																									
East-West Street		Gravelly-Thorne Connector Ln																																																																																																																																																																																																																																																																																																									
Count Date: 3/5/2013		2020																																																																																																																																																																																																																																																																																																									
Count Source: TC2																																																																																																																																																																																																																																																																																																											
EB	WB	NB	SB	Total																																																																																																																																																																																																																																																																																																							
7%		3%	0%																																																																																																																																																																																																																																																																																																								
PHF				0.80																																																																																																																																																																																																																																																																																																							
Peak Hour Used:																																																																																																																																																																																																																																																																																																											
From 715		To 815																																																																																																																																																																																																																																																																																																									
North-South Street		Thorne Ln																																																																																																																																																																																																																																																																																																									
East-West Street		Union Ave																																																																																																																																																																																																																																																																																																									
Count Date: 3/5/2013		2020																																																																																																																																																																																																																																																																																																									
Count Source: TC2																																																																																																																																																																																																																																																																																																											
EB	WB	NB	SB	Total																																																																																																																																																																																																																																																																																																							
7%		3%	0%																																																																																																																																																																																																																																																																																																								
PHF				0.80																																																																																																																																																																																																																																																																																																							
Peak Hour Used:																																																																																																																																																																																																																																																																																																											
From 715		To 815																																																																																																																																																																																																																																																																																																									
North-South Street		Thorne Ln																																																																																																																																																																																																																																																																																																									
East-West Street		Gravelly-Thorne Connector Ln																																																																																																																																																																																																																																																																																																									
Count Date: 3/5/2013		2020																																																																																																																																																																																																																																																																																																									
Count Source: TC2																																																																																																																																																																																																																																																																																																											
EB	WB	NB	SB	Total																																																																																																																																																																																																																																																																																																							
7%		3%	0%																																																																																																																																																																																																																																																																																																								
PHF				0.80																																																																																																																																																																																																																																																																																																							
Peak Hour Used:																																																																																																																																																																																																																																																																																																											
From 715		To 815																																																																																																																																																																																																																																																																																																									

AM PEAK HOUR TURNING MOVEMENT SUMMARY

Post-processed Data
from Mesoscopic Model

	Post-Processed EXISTING 2013 Model Volumes Peak Hour	Post-Processed NO BUILD P1 2020 Volumes Peak Hour	Post-Processed BUILD RB_sbGLC_noHOV_2020 Volumes Peak Hour	Post-Processed NO BUILD P1 2040 Volumes Peak Hour	Post-Processed BUILD RB_sbGLC_noHOV_2040 Volume Peak Hour															
<p>North-South Street East-West Street</p> <p>Count Date: 3/5/2013</p> <p>Count Source: TC2</p> <table border="1"> <tr><td>EB</td><td>WB</td><td>NB</td><td>SB</td><td>Total</td></tr> <tr><td>8%</td><td></td><td>5%</td><td>6%</td><td></td></tr> <tr><td colspan="5">PHF 0.87</td></tr> </table> <p>Peak Hour Used:</p> <p>From 715 To 815</p>	EB	WB	NB	SB	Total	8%		5%	6%		PHF 0.87					<p>16 Thorne Ln 2014 NB I-5 Ramps</p>	<p>20 Thorne Ln 2020 NB I-5 Ramps</p>	<p>19 Thorne Ln 2020 NB I-5 Ramps</p>	<p>Thorne Ln NB I-5 Ramps</p>	<p>19 Thorne Ln 2020 NB I-5 Ramps</p>
EB	WB	NB	SB	Total																
8%		5%	6%																	
PHF 0.87																				
<p>North-South Street East-West Street</p> <p>Count Date: 3/7/2013</p> <p>Count Source: TC2</p> <table border="1"> <tr><td>EB</td><td>WB</td><td>NB</td><td>SB</td><td>Total</td></tr> <tr><td></td><td>11%</td><td>4%</td><td>4%</td><td></td></tr> <tr><td colspan="5">PHF 0.95</td></tr> </table> <p>Peak Hour Used:</p> <p>From 715 To 815</p>	EB	WB	NB	SB	Total		11%	4%	4%		PHF 0.95					<p>17 Gravelly Lake Dr 2013 Pacific Hwy</p>	<p>21 Gravelly Lake Dr 2020 Pacific Hwy</p>	<p>21 Gravelly Lake Dr 2020 Pacific Hwy</p>	<p>Gravelly Lake Dr Pacific Hwy</p>	<p>21 Gravelly Lake Dr 2040 Pacific Hwy</p>
EB	WB	NB	SB	Total																
	11%	4%	4%																	
PHF 0.95																				
<p>North-South Street East-West Street</p> <p>Count Date: 3/7/2013</p> <p>Count Source: TC2</p> <table border="1"> <tr><td>EB</td><td>WB</td><td>NB</td><td>SB</td><td>Total</td></tr> <tr><td>4%</td><td></td><td>3%</td><td>2%</td><td></td></tr> <tr><td colspan="5">PHF 0.92</td></tr> </table> <p>Peak Hour Used:</p> <p>From 715 To 815</p>	EB	WB	NB	SB	Total	4%		3%	2%		PHF 0.92					<p>18 Gravelly Lake Dr 2013 SB I-5 Ramps</p>	<p>22 Gravelly Lake Dr 2020 SB I-5 Ramps</p>	<p>22 Gravelly Lake Dr 2020 SB I-5 Ramps</p>	<p>Gravelly Lake Dr SB I-5 Ramps</p>	<p>22 Gravelly Lake Dr 2040 SB I-5 Ramps</p>
EB	WB	NB	SB	Total																
4%		3%	2%																	
PHF 0.92																				
<p>North-South Street East-West Street</p> <p>Count Date: 3/7/2013</p> <p>Count Source: TC2</p> <table border="1"> <tr><td>EB</td><td>WB</td><td>NB</td><td>SB</td><td>Total</td></tr> <tr><td>2%</td><td></td><td>5%</td><td>2%</td><td></td></tr> <tr><td colspan="5">PHF 0.94</td></tr> </table> <p>Peak Hour Used:</p> <p>From 715 To 815</p>	EB	WB	NB	SB	Total	2%		5%	2%		PHF 0.94					<p>19 Gravelly Lake Dr 2013 NB I-5 Ramps</p>	<p>23 Gravelly Lake Dr 2020 NB I-5 Ramps</p>	<p>23 Gravelly Lake Dr 2020 NB I-5 Ramps</p>	<p>Gravelly Lake Dr NB I-5 Ramps</p>	<p>23 Gravelly Lake Dr 2040 NB I-5 Ramps</p>
EB	WB	NB	SB	Total																
2%		5%	2%																	
PHF 0.94																				

PM PEAK HOUR TURNING MOVEMENT SUMMARY

Post-processed Data
from Mesoscopic Model

Post-Processed
EXISTING
2013 Model Volumes
Peak Hour

Post-Processed
NO BUILD
P1 2020 Volumes
Peak Hour

Post-Processed
BUILD
RB_sbGLC_noHOV_2020 Volumes
Peak Hour

Post-Processed
NO BUILD
P1 2040 Volumes
Peak Hour

Post-Processed
BUILD
RB_sbGLC_noHOV_2040 Volume
Peak Hour

North-South Street East-West Street	3 2013	Center Dr Wilmington Dr																												
Count Date: 3/5/2013	<table border="1"> <tr><td colspan="2">675</td><td colspan="2">630</td></tr> <tr><td>10</td><td>605</td><td>60</td><td></td></tr> <tr><td>80</td><td>5</td><td></td><td>90</td></tr> <tr><td>15</td><td></td><td>1,795</td><td>25</td></tr> <tr><td>70</td><td>50</td><td></td><td>220</td></tr> <tr><td colspan="2">45</td><td colspan="2">135</td></tr> <tr><td colspan="2">875</td><td colspan="2">715</td></tr> </table>		675		630		10	605	60		80	5		90	15		1,795	25	70	50		220	45		135		875		715	
675		630																												
10	605	60																												
80	5		90																											
15		1,795	25																											
70	50		220																											
45		135																												
875		715																												
Count Source: TC2	<table border="1"> <tr><td>80</td><td>5</td><td></td><td>90</td><td>335</td></tr> <tr><td>15</td><td></td><td>1,795</td><td>25</td><td></td></tr> <tr><td>70</td><td>50</td><td></td><td>220</td><td>210</td></tr> </table>		80	5		90	335	15		1,795	25		70	50		220	210													
80	5		90	335																										
15		1,795	25																											
70	50		220	210																										
EB WB NB SB Total	<table border="1"> <tr><td>80</td><td>5</td><td></td><td>90</td><td>335</td></tr> <tr><td>15</td><td></td><td>1,795</td><td>25</td><td></td></tr> <tr><td>70</td><td>50</td><td></td><td>220</td><td>210</td></tr> </table>		80	5		90	335	15		1,795	25		70	50		220	210													
80	5		90	335																										
15		1,795	25																											
70	50		220	210																										
%HV 0% 0% 1% 1%																														
PHF 0.98																														
Peak Hour Used:																														
From 1630 To 1730																														

North-South Street East-West Street	4 2013	Center Dr SB I-5 Ramps																												
Count Date: 3/5/2013	<table border="1"> <tr><td colspan="2">885</td><td colspan="2">715</td></tr> <tr><td>665</td><td>220</td><td></td><td></td></tr> <tr><td>1,105</td><td></td><td></td><td>345</td></tr> <tr><td></td><td></td><td>2,040</td><td>0</td></tr> <tr><td>0</td><td></td><td></td><td>0</td></tr> <tr><td colspan="2">440</td><td colspan="2">370</td></tr> <tr><td colspan="2">220</td><td colspan="2">810</td></tr> </table>		885		715		665	220			1,105			345			2,040	0	0			0	440		370		220		810	
885		715																												
665	220																													
1,105			345																											
		2,040	0																											
0			0																											
440		370																												
220		810																												
Count Source: TC2	<table border="1"> <tr><td>1,105</td><td></td><td></td><td>345</td><td>345</td></tr> <tr><td></td><td></td><td>2,040</td><td>0</td><td></td></tr> <tr><td>0</td><td></td><td></td><td>0</td><td>0</td></tr> </table>		1,105			345	345			2,040	0		0			0	0													
1,105			345	345																										
		2,040	0																											
0			0	0																										
EB WB NB SB Total	<table border="1"> <tr><td>1,105</td><td></td><td></td><td>345</td><td>345</td></tr> <tr><td></td><td></td><td>2,040</td><td>0</td><td></td></tr> <tr><td>0</td><td></td><td></td><td>0</td><td>0</td></tr> </table>		1,105			345	345			2,040	0		0			0	0													
1,105			345	345																										
		2,040	0																											
0			0	0																										
%HV 1% 0% 1%																														
PHF 0.97																														
Peak Hour Used:																														
From 1630 To 1730																														

North-South Street East-West Street	4 2020	Center Dr SB I-5 Ramps																												
Count Date: 3/5/2013	<table border="1"> <tr><td colspan="2">990</td><td colspan="2">985</td></tr> <tr><td>875</td><td>115</td><td>0</td><td></td></tr> <tr><td>1,020</td><td>0</td><td></td><td>275</td></tr> <tr><td></td><td></td><td>2,120</td><td>0</td></tr> <tr><td>0</td><td></td><td></td><td>0</td></tr> <tr><td colspan="2">145</td><td colspan="2">710</td></tr> <tr><td colspan="2">115</td><td colspan="2">855</td></tr> </table>		990		985		875	115	0		1,020	0		275			2,120	0	0			0	145		710		115		855	
990		985																												
875	115	0																												
1,020	0		275																											
		2,120	0																											
0			0																											
145		710																												
115		855																												
Count Source: TC2	<table border="1"> <tr><td>1,020</td><td>0</td><td></td><td>275</td><td>275</td></tr> <tr><td></td><td></td><td>2,120</td><td>0</td><td></td></tr> <tr><td>0</td><td></td><td></td><td>0</td><td>0</td></tr> </table>		1,020	0		275	275			2,120	0		0			0	0													
1,020	0		275	275																										
		2,120	0																											
0			0	0																										
EB WB NB SB Total	<table border="1"> <tr><td>1,020</td><td>0</td><td></td><td>275</td><td>275</td></tr> <tr><td></td><td></td><td>2,120</td><td>0</td><td></td></tr> <tr><td>0</td><td></td><td></td><td>0</td><td>0</td></tr> </table>		1,020	0		275	275			2,120	0		0			0	0													
1,020	0		275	275																										
		2,120	0																											
0			0	0																										
%HV 1% 0% 1%																														
PHF 0.97																														
Peak Hour Used:																														
From 1630 To 1730																														

North-South Street East-West Street	4 2020	Center Dr SB I-5 Ramps																												
Count Date: 3/5/2013	<table border="1"> <tr><td colspan="2">1,130</td><td colspan="2">770</td></tr> <tr><td>1,015</td><td>115</td><td>0</td><td></td></tr> <tr><td>1,015</td><td>0</td><td></td><td>85</td></tr> <tr><td></td><td></td><td>1,900</td><td>0</td></tr> <tr><td>0</td><td></td><td></td><td>0</td></tr> <tr><td colspan="2">0</td><td colspan="2">685</td></tr> <tr><td colspan="2">115</td><td colspan="2">685</td></tr> </table>		1,130		770		1,015	115	0		1,015	0		85			1,900	0	0			0	0		685		115		685	
1,130		770																												
1,015	115	0																												
1,015	0		85																											
		1,900	0																											
0			0																											
0		685																												
115		685																												
Count Source: TC2	<table border="1"> <tr><td>1,015</td><td>0</td><td></td><td>85</td><td>85</td></tr> <tr><td></td><td></td><td>1,900</td><td>0</td><td></td></tr> <tr><td>0</td><td></td><td></td><td>0</td><td>0</td></tr> </table>		1,015	0		85	85			1,900	0		0			0	0													
1,015	0		85	85																										
		1,900	0																											
0			0	0																										
EB WB NB SB Total	<table border="1"> <tr><td>1,015</td><td>0</td><td></td><td>85</td><td>85</td></tr> <tr><td></td><td></td><td>1,900</td><td>0</td><td></td></tr> <tr><td>0</td><td></td><td></td><td>0</td><td>0</td></tr> </table>		1,015	0		85	85			1,900	0		0			0	0													
1,015	0		85	85																										
		1,900	0																											
0			0	0																										
%HV 1% 0% 1%																														
PHF 0.97																														
Peak Hour Used:																														
From 1630 To 1730																														

North-South Street East-West Street	4 2040	Center Dr SB I-5 Ramps																												
Count Date: 3/5/2013	<table border="1"> <tr><td colspan="2">1,035</td><td colspan="2">875</td></tr> <tr><td>900</td><td>135</td><td>0</td><td></td></tr> <tr><td>1,020</td><td>0</td><td></td><td>140</td></tr> <tr><td></td><td></td><td>2,030</td><td>0</td></tr> <tr><td>0</td><td></td><td></td><td>0</td></tr> <tr><td colspan="2">120</td><td colspan="2">735</td></tr> <tr><td colspan="2">135</td><td colspan="2">855</td></tr> </table>		1,035		875		900	135	0		1,020	0		140			2,030	0	0			0	120		735		135		855	
1,035		875																												
900	135	0																												
1,020	0		140																											
		2,030	0																											
0			0																											
120		735																												
135		855																												
Count Source: TC2	<table border="1"> <tr><td>1,020</td><td>0</td><td></td><td>140</td><td>140</td></tr> <tr><td></td><td></td><td>2,030</td><td>0</td><td></td></tr> <tr><td>0</td><td></td><td></td><td>0</td><td>0</td></tr> </table>		1,020	0		140	140			2,030	0		0			0	0													
1,020	0		140	140																										
		2,030	0																											
0			0	0																										
EB WB NB SB Total	<table border="1"> <tr><td>1,020</td><td>0</td><td></td><td>140</td><td>140</td></tr> <tr><td></td><td></td><td>2,030</td><td>0</td><td></td></tr> <tr><td>0</td><td></td><td></td><td>0</td><td>0</td></tr> </table>		1,020	0		140	140			2,030	0		0			0	0													
1,020	0		140	140																										
		2,030	0																											
0			0	0																										
%HV 1% 0% 1%																														
PHF 0.97																														
Peak Hour Used:																														
From 1630 To 1730																														

North-South Street East-West Street	5 2013	Center Dr NB I-5 Ramps																								
Count Date: 3/5/2013	<table border="1"> <tr><td colspan="2">220</td><td colspan="2">810</td></tr> <tr><td>590</td><td></td><td></td><td></td></tr> <tr><td>0</td><td>590</td><td></td><td>0</td></tr> <tr><td></td><td></td><td>1,035</td><td></td></tr> <tr><td>590</td><td></td><td></td><td>0</td></tr> <tr><td colspan="2">220</td><td colspan="2">220</td></tr> </table>		220		810		590				0	590		0			1,035		590			0	220		220	
220		810																								
590																										
0	590		0																							
		1,035																								
590			0																							
220		220																								
Count Source: TC2	<table border="1"> <tr><td>0</td><td>590</td><td></td><td></td><td>0</td></tr> <tr><td></td><td></td><td>1,035</td><td></td><td></td></tr> <tr><td>590</td><td></td><td></td><td></td><td>0</td></tr> </table>		0	590			0			1,035			590				0									
0	590			0																						
		1,035																								
590				0																						
EB WB NB SB Total	<table border="1"> <tr><td>0</td><td>590</td><td></td><td></td><td>0</td></tr> <tr><td></td><td></td><td>1,035</td><td></td><td></td></tr> <tr><td>590</td><td></td><td></td><td></td><td>0</td></tr> </table>		0	590			0			1,035			590				0									
0	590			0																						
		1,035																								
590				0																						
%HV 0% 0% 0% 1%																										
PHF 0.90																										
Peak Hour Used:																										
From 1630 To 1730																										

North-South Street East-West Street	5 2020	Center Dr NB I-5 Ramps																								
Count Date: 3/5/2013	<table border="1"> <tr><td colspan="2">115</td><td colspan="2">855</td></tr> <tr><td>0</td><td>0</td><td>115</td><td></td></tr> <tr><td>0</td><td>0</td><td></td><td>550</td></tr> <tr><td></td><td></td><td>970</td><td>0</td></tr> <tr><td>0</td><td></td><td></td><td>115</td></tr> <tr><td colspan="2">0</td><td colspan="2">305</td></tr> </table>		115		855		0	0	115		0	0		550			970	0	0			115	0		305	
115		855																								
0	0	115																								
0	0		550																							
		970	0																							
0			115																							
0		305																								
Count Source: TC2	<table border="1"> <tr><td>0</td><td>0</td><td></td><td>550</td><td>550</td></tr> <tr><td></td><td></td><td>970</td><td>0</td><td></td></tr> <tr><td>0</td><td></td><td></td><td>115</td><td>115</td></tr> </table>		0	0		550	550			970	0		0			115	115									
0	0		550	550																						
		970	0																							
0			115	115																						
EB WB NB SB Total	<table border="1"> <tr><td>0</td><td>0</td><td></td><td>550</td><td>550</td></tr> <tr><td></td><td></td><td>970</td><td>0</td><td></td></tr> <tr><td>0</td><td></td><td></td><td>115</td><td>115</td></tr> </table>		0	0		550	550			970	0		0			115	115									
0	0		550	550																						
		970	0																							
0			115	115																						
%HV 0% 0% 0% 1%																										
PHF 0.90																										
Peak Hour Used:																										
From 1630 To 1730																										

North-South Street East-West Street	5 2020	Center Dr NB I-5 Ramps																								
Count Date: 3/5/2013	<table border="1"> <tr><td colspan="2">115</td><td colspan="2">685</td></tr> <tr><td>0</td><td>0</td><td>115</td><td></td></tr> <tr><td>0</td><td>0</td><td></td><td>450</td></tr> <tr><td></td><td></td><td>800</td><td>0</td></tr> <tr><td>0</td><td></td><td></td><td>115</td></tr> <tr><td colspan="2">0</td><td colspan="2">235</td></tr> </table>		115		685		0	0	115		0	0		450			800	0	0			115	0		235	
115		685																								
0	0	115																								
0	0		450																							
		800	0																							
0			115																							
0		235																								
Count Source: TC2	<table border="1"> <tr><td>0</td><td>0</td><td></td><td>450</td><td>450</td></tr> <tr><td></td><td></td><td>800</td><td>0</td><td></td></tr> <tr><td>0</td><td></td><td></td><td>115</td><td>115</td></tr> </table>		0	0		450	450			800	0		0			115	115									
0	0		450	450																						
		800	0																							
0			115	115																						
EB WB NB SB Total	<table border="1"> <tr><td>0</td><td>0</td><td></td><td>450</td><td>450</td></tr> <tr><td></td><td></td><td>800</td><td>0</td><td></td></tr> <tr><td>0</td><td></td><td></td><td>115</td><td>115</td></tr> </table>		0	0		450	450			800	0		0			115	115									
0	0		450	450																						
		800	0																							
0			115	115																						
%HV 0% 0% 0% 1%																										
PHF 0.90																										
Peak Hour Used:																										
From 1630 To 1730																										

North-South Street East-West Street	5 2020	Center Dr NB I-5 Ramps																								
Count Date: 3/5/2013	<table border="1"> <tr><td colspan="2">115</td><td colspan="2">650</td></tr> <tr><td>0</td><td>0</td><td>115</td><td></td></tr> <tr><td>0</td><td>0</td><td></td><td>335</td></tr> <tr><td></td><td></td><td>765</td><td>0</td></tr> <tr><td>0</td><td></td><td></td><td>115</td></tr> <tr><td colspan="2">0</td><td colspan="2">315</td></tr> </table>		115		650		0	0	115		0	0		335			765	0	0			115	0		315	
115		650																								
0	0	115																								
0	0		335																							
		765	0																							
0			115																							
0		315																								
Count Source: TC2	<table border="1"> <tr><td>0</td><td>0</td><td></td><td>335</td><td>335</td></tr> <tr><td></td><td></td><td>765</td><td>0</td><td></td></tr> <tr><td>0</td><td></td><td></td><td>115</td><td>115</td></tr> </table>		0	0		335	335			765	0		0			115	115									
0	0		335	335																						
		765	0																							
0			115	115																						
EB WB NB SB Total	<table border="1"> <tr><td>0</td><td>0</td><td></td><td>335</td><td>335</td></tr> <tr><td></td><td></td><td>765</td><td>0</td><td></td></tr> <tr><td>0</td><td></td><td></td><td>115</td><td>115</td></tr> </table>		0	0		335	335			765	0		0			115	115									
0	0		335	335																						
		765	0																							
0			115	115																						
%HV 0% 0% 0% 1%																										
PHF 0.90																										
Peak Hour Used:																										
From 1630 To 1730																										

North-South Street East-West Street	5 2040	Center Dr NB I-5 Ramps																								
Count Date: 3/5/2013	<table border="1"> <tr><td colspan="2">135</td><td colspan="2">855</td></tr> <tr><td>0</td><td>0</td><td>135</td><td></td></tr> <tr><td>0</td><td>0</td><td></td><td>410</td></tr> <tr><td></td><td></td><td>990</td><td>0</td></tr> <tr><td>0</td><td></td><td></td><td>135</td></tr> <tr><td colspan="2">0</td><td colspan="2">445</td></tr> </table>		135		855		0	0	135		0	0		410			990	0	0			135	0		445	
135		855																								
0	0	135																								
0	0		410																							
		990	0																							
0			135																							
0		445																								
Count Source: TC2	<table border="1"> <tr><td>0</td><td>0</td><td></td><td>410</td><td>410</td></tr> <tr><td></td><td></td><td>990</td><td>0</td><td></td></tr> <tr><td>0</td><td></td><td></td><td>135</td><td>135</td></tr> </table>		0	0		410	410			990	0		0			135	135									
0	0		410	410																						
		990	0																							
0			135	135																						
EB WB NB SB Total	<table border="1"> <tr><td>0</td><td>0</td><td></td><td>410</td><td>410</td></tr> <tr><td></td><td></td><td>990</td><td>0</td><td></td></tr> <tr><td>0</td><td></td><td></td><td>135</td><td>135</td></tr> </table>		0	0		410	410			990	0		0			135	135									
0	0		410	410																						
		990	0																							
0			135	135																						
%HV 0% 0% 0% 1%																										
PHF 0.90																										
Peak Hour Used:																										
From 1630 To 1730																										

North-South Street East-West Street	6 2013	Steilacoom-DuPont Rd Wilmington Dr																												
Count Date: 2/14/2013	<table border="1"> <tr><td colspan="2">145</td><td colspan="2">150</td></tr> <tr><td>25</td><td>80</td><td>45</td><td></td></tr> <tr><td>245</td><td>25</td><td></td><td>35</td></tr> <tr><td>110</td><td></td><td>1,815</td><td>50</td></tr> <tr><td>265</td><td>130</td><td></td><td>590</td></tr> <tr><td colspan="2">175</td><td colspan="2">465</td></tr> <tr><td colspan="2">800</td><td colspan="2">730</td></tr> </table>		145		150		25	80	45		245	25		35	110		1,815	50	265	130		590	175		465		800		730	
145		150																												
25	80	45																												
245	25		35																											
110		1,815	50																											
265	130		590																											
175		465																												
800		730																												
Count Source: TC2	<table border="1"> <tr><td>245</td><td>25</td><td></td><td>35</td><td>675</td></tr> <tr><td>110</td><td></td><td>1,815</td><td>50</td><td></td></tr> <tr><td>265</td><td>130</td><td></td><td>590</td><td>620</td></tr> </table>		245	25		35	675	110		1,815	50		265	130		590	620													
245	25		35	675																										
110		1,815	50																											
265	130		590	620																										
EB WB NB SB Total	<table border="1"> <tr><td>245</td><td>25</td><td></td><td>35</td><td>675</td></tr> <tr><td>110</td><td></td><td>1,815</td><td>50</td><td></td></tr> <tr><td>265</td><td>130</td><td></td><td>590</td><td>620</td></tr> </table>		245	25		35	675	110		1,815	50		265	130		590	620													
245	25		35	675																										
110		1,815	50																											
265	130		590	620																										
%HV 0% 0% 2% 1%																														
PHF 0.96																														
Peak Hour Used:																														
From 1630 To 1730																														

North-South Street East-West Street	6 2020	Barksdale Ave Wilmington Dr																												
Count Date: 2/14/2013	<table border="1"> <tr><td colspan="2">150</td><td colspan="2">170</td></tr> <tr><td>25</td><td>85</td><td>40</td><td></td></tr> <tr><td>255</td><td>35</td><td></td><td>30</td></tr> <tr><td>100</td><td></td><td>2,020</td><td>40</td></tr> <tr><td>620</td><td>485</td><td></td><td>575</td></tr> <tr><td colspan="2">190</td><td colspan="2">310</td></tr> <tr><td colspan="2">1,145</td><td colspan="2">605</td></tr> </table>		150		170		25	85	40		255	35		30	100		2,020	40	620	485		575	190		310		1,145		605	
150		170																												
25	85	40																												
255	35		30																											
100		2,020	40																											
620	485		575																											
190		310																												
1,145		605																												
Count Source: TC2	<table border="1"> <tr><td>255</td><td>35</td><td></td><td>30</td><td>645</td></tr> <tr><td>100</td><td></td><td>2,020</td><td>40</td><td></td></tr> <tr><td>620</td><td>485</td><td></td><td>575</td><td>450</td></tr> </table>		255	35		30	645	100		2,020	40		620	485		575	450													
255	35		30	645																										
100		2,020	40																											
620	485		575	450																										
EB WB NB SB Total	<table border="1"> <tr><td>255</td><td>35</td><td></td><td>30</td><td>645</td></tr> <tr><td>100</td><td></td><td>2,020</td><td>40</td><td></td></tr> <tr><td>620</td><td>485</td><td></td><td>575</td><td>450</td></tr> </table>		255	35		30	645	100		2,020	40		620	485		575	450													
255	35		30	645																										
100		2,020	40																											
620	485		575	450																										
%HV 0% 0% 2% 1%																														
PHF 0.96																														
Peak Hour Used:																														
From 1630 To 1730																														

North-South Street East-West Street	6 2020	Barksdale Ave Wilmington Dr																												
Count Date: 2/14/2013	<table border="1"> <tr><td colspan="2">140</td><td colspan="2">165</td></tr> <tr><td>20</td><td>80</td><td>40</td><td></td></tr> <tr><td>400</td><td>45</td><td></td><td>30</td></tr> <tr><td>135</td><td></td><td>2,580</td><td>50</td></tr> <tr><td>745</td><td>565</td><td></td><td>710</td></tr> <tr><td colspan="2">330</td><td colspan="2">485</td></tr> <tr><td colspan="2">1,355</td><td colspan="2">905</td></tr> </table>		140		165		20	80	40		400	45		30	135		2,580	50	745	565		710	330		485		1,355		905	
140		165																												
20	80	40																												
400	45		30																											
135		2,580	50																											
745	565		710																											
330		485																												
1,355		905																												
Count Source: TC2	<table border="1"> <tr><td>400</td><td>45</td><td></td><td>30</td><td>790</td></tr> <tr><td>135</td><td></td><td>2,580</td><td>50</td><td></td></tr> <tr><td>745</td><td>565</td><td></td><td>710</td><td>660</td></tr> </table>		400	45		30	790	135		2,580	50		745	565		710	660													
400	45		30	790																										
135		2,580	50																											
745	565		710	660																										
EB WB NB SB Total	<table border="1"> <tr><td>400</td><td>45</td><td></td><td>30</td><td>790</td></tr> <tr><td>135</td><td></td><td>2,580</td><td>50</td><td></td></tr> <tr><td>745</td><td>565</td><td></td><td>710</td><td>660</td></tr> </table>		400	45		30	790	135		2,580	50		745	565		710	660													
400	45		30	790																										
135		2,580	50																											
745	565		710	660																										
%HV 0% 0% 2% 1%																														
PHF 0.96																														
Peak Hour Used:																														
From 1630 To 1730																														

North-South Street East-West Street	6 2040	Barksdale Ave Wilmington Dr																												
Count Date: 2/14/2013	<table border="1"> <tr><td colspan="2">170</td><td colspan="2">140</td></tr> <tr><td>25</td><td>100</td><td>50</td><td></td></tr> <tr><td>220</td><td>25</td><td></td><td>25</td></tr> <tr><td>180</td><td></td><td>2,420</td><td>50</td></tr> <tr><td>675</td><td>560</td><td></td><td>590</td></tr> <tr><td colspan="2">180</td><td colspan="2">435</td></tr> <tr><td colspan="2">1,365</td><td colspan="2">705</td></tr> </table>		170		140		25	100	50		220	25		25	180		2,420	50	675	560		590	180		435		1,365		705	
170		140																												
25	100	50																												
220	25		25																											
180		2,420	50																											
675	560		590																											
180		435																												
1,365		705																												
Count Source: TC2	<table border="1"> <tr><td>220</td><td>25</td><td></td><td>25</td><td>730</td></tr> <tr><td>180</td><td></td><td>2,420</td><td>50</td><td></td></tr> <tr><td>675</td><td>560</td><td></td><td>590</td><td>715</td></tr> </table>		220	25		25	730	180		2,420	50		675	560		590	715													
220	25		25	730																										
180		2,420	50																											
675	560		590	715																										
EB WB NB SB Total	<table border="1"> <tr><td>220</td><td>25</td><td></td><td>25</td><td>730</td></tr> <tr><td>180</td><td></td><td>2,420</td><td>50</td><td></td></tr> <tr><td>675</td><td>560</td><td></td><td>590</td><td>715</td></tr> </table>		220	25		25	730	180		2,420	50		675	560		590	715													
220	25		25	730																										
180		2,420	50																											
675	560		590	715																										
%HV 0% 0% 2% 1%																														
PHF 0.96																														
Peak Hour Used:																														
From 1630 To 1730																														

North-South Street East-West Street	6 2040	Steilacoom-DuPont Rd Wilmington Dr																												
Count Date: 2/14/2013	<table border="1"> <tr><td colspan="2">165</td><td colspan="2">135</td></tr> <tr><td>25</td><td>95</td><td>45</td><td></td></tr> <tr><td>220</td><td>25</td><td></td><td>25</td></tr> <tr><td>135</td><td></td><td>2,380</td><td>50</td></tr> <tr><td>720</td><td>560</td><td></td><td>655</td></tr> <tr><td colspan="2">145</td><td colspan="2">535</td></tr> <tr><td colspan="2">1,310</td><td colspan="2">765</td></tr> </table>		165		135		25	95	45		220	25		25	135		2,380	50	720	560		655	145		535		1,310		765	
165		135																												
25	95	45																												
220	25		25																											
135		2,380	50																											
720	560		655																											
145		535																												
1,310		765																												
Count Source: TC2	<table border="1"> <tr><td>220</td><td>25</td><td></td><td>25</td><td>730</td></tr> <tr><td>135</td><td></td><td>2,380</td><td>50</td><td></td></tr> <tr><td>720</td><td>560</td><td></td><td>655</td><td>715</td></tr> </table>		220	25		25	730	135		2,380	50		720	560		655	715													
220	25		25	730																										
135		2,380	50																											
720	560		655	715																										
EB WB NB SB Total	<table border="1"> <tr><td>220</td><td>25</td><td></td><td>25</td><td>730</td></tr> <tr><td>135</td><td></td><td>2,380</td><td>50</td><td></td></tr> <tr><td>720</td><td>560</td><td></td><td>655</td><td>715</td></tr> </table>		220	25		25	730	135		2,380	50		720	560		655	715													
220	25		25	730																										
135		2,380	50																											
720	560		655	715																										
%HV 0% 0% 2% 1%																														
PHF 0.96																														
Peak Hour Used:																														
From 1630 To 1730																														

North-South Street East-West Street	6 2040	Barksdale Ave Wilmington Dr																												
Count Date: 2/14/2013	<table border="1"> <tr><td colspan="2">165</td><td colspan="2">135</td></tr> <tr><td>25</td><td>95</td><td>45</td><td></td></tr> <tr><td>220</td><td>25</td><td></td><td>25</td></tr> <tr><td>135</td><td></td><td>2,380</td><td>50</td></tr> <tr><td>720</td><td>560</td><td></td><td>655</td></tr> <tr><td colspan="2">145</td><td colspan="2">535</td></tr> <tr><td colspan="2">1,310</td><td colspan="2">765</td></tr> </table>		165		135		25	95	45		220	25		25	135		2,380	50	720	560		655	145		535		1,310		765	
165		135																												
25	95	45																												
220	25		25																											
135		2,380	50																											
720	560		655																											
145		535																												
1,310		765																												
Count Source: TC2	<table border="1"> <tr><td>220</td><td>25</td><td></td><td>25</td><td>730</td></tr> <tr><td>135</td><td></td><td>2,380</td><td>50</td><td></td></tr> <tr><td>720</td><td>560</td><td></td><td>655</td><td>715</td></tr> </table>		220	25		25	730	135		2,380	50		720	560		655	715													
220	25		25	730																										
135		2,380	50																											
720	560		655	715																										
EB WB NB SB Total	<table border="1"> <tr><td>220</td><td>25</td><td></td><td>25</td><td>730</td></tr> <tr><td>135</td><td></td><td>2,380</td><td>50</td><td></td></tr> <tr><td>720</td><td>560</td><td></td><td>655</td><td>715</td></tr> </table>		220	25		25	730	135		2,380	50		720	560		655	715													
220	25		25	730																										
135		2,380	50																											
720	560		655	715																										
%HV 0% 0% 2% 1%																														
PHF 0.96																														
Peak Hour Used:																														
From 1630 To 1730																														

PM PEAK HOUR TURNING MOVEMENT SUMMARY

Post-processed Data
from Mesoscopic Model

Post-Processed
EXISTING
2013 Model Volumes
Peak Hour

Post-Processed
NO BUILD
P1 2020 Volumes
Peak Hour

Post-Processed
BUILD
RB_sbGLC_noHOV_2020 Volumes
Peak Hour

Post-Processed
NO BUILD
P1 2040 Volumes
Peak Hour

Post-Processed
BUILD
RB_sbGLC_noHOV_2040 Volume
Peak Hour

North-South Street	7	Steilacoom-DuPont Rd
East-West Street	2013	SB I-5 Ramps
Count Date:	2/14/2013	
Count Source:	TC2	
EB	WB	NB
10%	1%	4%
%HV	0.97	
PHF	0.97	
Peak Hour Used:	From 1630 To 1730	

865	800	730	165	185
	325	475		
	2,090			0
0			20	0
	540	565		
	495	1,105		

850	1,145	605	110	125
0	325	820	0	
0	2,290			0
0			15	0
	525	495	0	
	835	1,020		

950	1,355	905	305	325
0	465	890	0	
0	2,765			0
0			20	0
	485	600	0	
	910	1,065		

0	1,365	705	130	155
0	555	810	0	
0	2,635			0
0			25	0
	540	575	0	
	835	1,115		

810	1,310	765	145	180
0	385	925	0	
0	2,535			0
0			35	0
	425	620	0	
	960	1,045		

North-South Street	8	Steilacoom-DuPont Rd
East-West Street	2013	NB I-5 Ramps
Count Date:	2/14/2013	
Count Source:	TC2	
EB	WB	NB
2%	0%	3%
%HV	0.97	
PHF	0.97	
Peak Hour Used:	From 1630 To 1730	

0	495	1,105		0
	400	85	410	
	2,020			
635				605
	10			
	225	705	185	
	310	890		

0	835	1,020		0
	310	80	755	
	2,275			
520				975
	10			
	200	710	210	
	280	920		

0	910	1,085		0
	395	130	780	
	2,580			
630				1,140
	10			
	225	690	350	
	355	1,040		

400	835	1,115		0
	0	105	730	
	2,175			
10				945
	10			
	0	715	205	
	115	920		

0	960	1,045		0
	425	155	805	
	2,360			
555				1,040
	10			
	120	620	225	
	275	845		

North-South Street	9	41ST DIVISION DR S
East-West Street	2013	I-5 SB Off Ramp
Count Date:	2/13/2013	
Count Source:	TC2 (tube)	
EB	WB	NB
2%	2%	4%
%HV	0.98	
PHF	0.98	
Peak Hour Used:	From 1630 To 1730	

435	1,375	840	180	180
	435	940		
	3,225			
225				785
	225	660	785	
	1,165	1,445		

410	1,435	740	50	50
	410	1,025	0	
	2,960			
50				735
	50	690	735	
	1,075	1,425		

120	990	660	165	165
	120	870	0	
	2,195			
125				420
	125	495	420	
	995	915		

0	1,350	730	100	100
	455	895	0	
	2,950			
180				690
	0	630	690	
	1,075	1,320		

120	1,090	750	50	50
	120	970	0	
	2,400			
120				440
	120	700	440	
	1,090	1,140		

North-South Street	10	41ST DIVISION DR S
East-West Street	2013	I-5 NB Off Ramp
Count Date:	2/13/2013	
Count Source:	TC2 (tube)	
EB	WB	NB
2%	3%	11%
%HV	0.96	
PHF	0.96	
Peak Hour Used:	From 1630 To 1730	

450	1,195	1,445	60	60
	450	745		
	3,205			
120				445
	120	1,385	445	
	865	1,830		

420	1,075	1,425	25	25
	420	655	0	
	2,985			
50				435
	50	1,400	435	
	705	1,835		

465	995	915	40	40
	465	530	0	
	2,510			
80				520
	80	875	520	
	610	1,395		

0	1,075	1,320	50	50
	455	620	0	
	2,880			
45				440
	0	1,270	440	
	665	1,710		

490	1,090	1,140	160	160
	490	600	0	
	2,765			
100				435
	100	980	435	
	700	1,415		

PM PEAK HOUR TURNING MOVEMENT SUMMARY

Post-processed Data
from Mesoscopic Model

Post-Processed
EXISTING
2013 Model Volumes
Peak Hour

Post-Processed
NO BUILD
P1 2020 Volumes
Peak Hour

Post-Processed
BUILD
RB_sbGLC_noHOV_2020 Volumes
Peak Hour

Post-Processed
NO BUILD
P1 2040 Volumes
Peak Hour

Post-Processed
BUILD
RB_sbGLC_noHOV_2040 Volume
Peak Hour

North-South Street East-West Street
NEW INTERSECTION BUILD ALTERNATIVE
North-South Street East-West Street
TRUCK DATA NOT AVAILABLE

11A Berkeley St 2020 Washington Ave																																			
<table border="1"> <tr><td></td><td>265</td><td></td><td>70</td><td></td></tr> <tr><td></td><td>0</td><td>260</td><td>5</td><td></td></tr> <tr><td>5</td><td>0</td><td>400</td><td>0</td><td>5</td></tr> <tr><td></td><td>0</td><td></td><td></td><td>0</td></tr> <tr><td>5</td><td>5</td><td></td><td></td><td>20</td></tr> <tr><td></td><td>5</td><td>65</td><td>35</td><td></td></tr> <tr><td></td><td>265</td><td></td><td>105</td><td></td></tr> </table>		265		70			0	260	5		5	0	400	0	5		0			0	5	5			20		5	65	35			265		105	
	265		70																																
	0	260	5																																
5	0	400	0	5																															
	0			0																															
5	5			20																															
	5	65	35																																
	265		105																																

14 Berkeley St 2020 Washington Ave																																			
<table border="1"> <tr><td></td><td>405</td><td></td><td>105</td><td></td></tr> <tr><td></td><td>0</td><td>395</td><td>10</td><td></td></tr> <tr><td>5</td><td>0</td><td>570</td><td>15</td><td>40</td></tr> <tr><td></td><td>0</td><td></td><td>0</td><td></td></tr> <tr><td>5</td><td>5</td><td></td><td>25</td><td>35</td></tr> <tr><td></td><td>5</td><td>90</td><td>25</td><td></td></tr> <tr><td></td><td>425</td><td></td><td>120</td><td></td></tr> </table>		405		105			0	395	10		5	0	570	15	40		0		0		5	5		25	35		5	90	25			425		120	
	405		105																																
	0	395	10																																
5	0	570	15	40																															
	0		0																																
5	5		25	35																															
	5	90	25																																
	425		120																																

11 Berkeley Ave 2020 Berkeley Interchange Ramp																																			
<table border="1"> <tr><td></td><td>175</td><td></td><td>455</td><td></td></tr> <tr><td></td><td>140</td><td>35</td><td>0</td><td></td></tr> <tr><td>280</td><td>415</td><td>920</td><td>0</td><td>0</td></tr> <tr><td></td><td>0</td><td></td><td>0</td><td></td></tr> <tr><td>565</td><td>150</td><td></td><td>0</td><td>0</td></tr> <tr><td></td><td>140</td><td>40</td><td>0</td><td></td></tr> <tr><td></td><td>185</td><td></td><td>180</td><td></td></tr> </table>		175		455			140	35	0		280	415	920	0	0		0		0		565	150		0	0		140	40	0			185		180	
	175		455																																
	140	35	0																																
280	415	920	0	0																															
	0		0																																
565	150		0	0																															
	140	40	0																																
	185		180																																

Berkeley St Washington Ave																																			
<table border="1"> <tr><td></td><td>345</td><td></td><td>105</td><td></td></tr> <tr><td></td><td>0</td><td>340</td><td>5</td><td></td></tr> <tr><td>0</td><td>0</td><td>530</td><td>10</td><td>35</td></tr> <tr><td></td><td>0</td><td></td><td>0</td><td></td></tr> <tr><td>5</td><td>5</td><td></td><td>25</td><td>50</td></tr> <tr><td></td><td>5</td><td>95</td><td>45</td><td></td></tr> <tr><td></td><td>370</td><td></td><td>145</td><td></td></tr> </table>		345		105			0	340	5		0	0	530	10	35		0		0		5	5		25	50		5	95	45			370		145	
	345		105																																
	0	340	5																																
0	0	530	10	35																															
	0		0																																
5	5		25	50																															
	5	95	45																																
	370		145																																

11 Berkeley Ave 2040 Berkeley Interchange Ramp																																			
<table border="1"> <tr><td></td><td>195</td><td></td><td>235</td><td></td></tr> <tr><td></td><td>180</td><td>15</td><td>0</td><td></td></tr> <tr><td>310</td><td>170</td><td>730</td><td>0</td><td>0</td></tr> <tr><td></td><td>0</td><td></td><td>0</td><td></td></tr> <tr><td>340</td><td>170</td><td></td><td>0</td><td>0</td></tr> <tr><td></td><td>130</td><td>65</td><td>0</td><td></td></tr> <tr><td></td><td>185</td><td></td><td>195</td><td></td></tr> </table>		195		235			180	15	0		310	170	730	0	0		0		0		340	170		0	0		130	65	0			185		195	
	195		235																																
	180	15	0																																
310	170	730	0	0																															
	0		0																																
340	170		0	0																															
	130	65	0																																
	185		195																																

North-South Street East-West Street
Count Date: 2/14/2013 Count Source: TC2 EB WB NB SB Total %HV 0% 0% 1% 5% PHF 0.96 Peak Hour Used: From 1630 To 1730
North-South Street East-West Street
Count Date: 2/14/2013 Count Source: TC2 EB WB NB SB Total %HV 1% 0% 1% PHF 0.95 Peak Hour Used: From 1630 To 1730

11 Berkeley St 2013 Union Ave																																			
<table border="1"> <tr><td></td><td>265</td><td></td><td>105</td><td></td></tr> <tr><td></td><td>0</td><td>260</td><td>25</td><td></td></tr> <tr><td>5</td><td>0</td><td>800</td><td>30</td><td>215</td></tr> <tr><td></td><td>0</td><td></td><td>5</td><td></td></tr> <tr><td>0</td><td>0</td><td></td><td>180</td><td>250</td></tr> <tr><td></td><td>0</td><td>75</td><td>225</td><td></td></tr> <tr><td></td><td>440</td><td></td><td>300</td><td></td></tr> </table>		265		105			0	260	25		5	0	800	30	215		0		5		0	0		180	250		0	75	225			440		300	
	265		105																																
	0	260	25																																
5	0	800	30	215																															
	0		5																																
0	0		180	250																															
	0	75	225																																
	440		300																																
12 Berkeley St 2013 SB I-5 Ramps																																			
<table border="1"> <tr><td></td><td>385</td><td></td><td>295</td><td></td></tr> <tr><td></td><td>155</td><td>230</td><td></td><td></td></tr> <tr><td>580</td><td></td><td>1,300</td><td>55</td><td>255</td></tr> <tr><td></td><td></td><td></td><td>5</td><td></td></tr> <tr><td>0</td><td></td><td></td><td>195</td><td>0</td></tr> <tr><td></td><td>420</td><td>240</td><td></td><td></td></tr> <tr><td></td><td>425</td><td></td><td>660</td><td></td></tr> </table>		385		295			155	230			580		1,300	55	255				5		0			195	0		420	240				425		660	
	385		295																																
	155	230																																	
580		1,300	55	255																															
			5																																
0			195	0																															
	420	240																																	
	425		660																																

14 Berkeley St 2020 Union Ave																																			
<table border="1"> <tr><td></td><td>425</td><td></td><td>120</td><td></td></tr> <tr><td></td><td>0</td><td>400</td><td>25</td><td></td></tr> <tr><td>5</td><td>0</td><td>860</td><td>30</td><td>160</td></tr> <tr><td></td><td>0</td><td></td><td>5</td><td></td></tr> <tr><td>5</td><td>5</td><td></td><td>125</td><td>205</td></tr> <tr><td></td><td>0</td><td>90</td><td>180</td><td></td></tr> <tr><td></td><td>530</td><td></td><td>270</td><td></td></tr> </table>		425		120			0	400	25		5	0	860	30	160		0		5		5	5		125	205		0	90	180			530		270	
	425		120																																
	0	400	25																																
5	0	860	30	160																															
	0		5																																
5	5		125	205																															
	0	90	180																																
	530		270																																
15 Berkeley St 2020 SB I-5 Ramps																																			
<table border="1"> <tr><td></td><td>530</td><td></td><td>270</td><td></td></tr> <tr><td></td><td>260</td><td>270</td><td>0</td><td></td></tr> <tr><td>565</td><td>0</td><td>1,510</td><td>5</td><td>415</td></tr> <tr><td></td><td>0</td><td></td><td>5</td><td></td></tr> <tr><td>0</td><td>0</td><td></td><td>405</td><td>0</td></tr> <tr><td></td><td>300</td><td>265</td><td>0</td><td></td></tr> <tr><td></td><td>675</td><td></td><td>565</td><td></td></tr> </table>		530		270			260	270	0		565	0	1,510	5	415		0		5		0	0		405	0		300	265	0			675		565	
	530		270																																
	260	270	0																																
565	0	1,510	5	415																															
	0		5																																
0	0		405	0																															
	300	265	0																																
	675		565																																

13 Berkeley Ave 2020 Union Ave																																			
<table border="1"> <tr><td></td><td>185</td><td></td><td>115</td><td></td></tr> <tr><td></td><td>10</td><td>0</td><td>175</td><td></td></tr> <tr><td>15</td><td>0</td><td>305</td><td>115</td><td>120</td></tr> <tr><td></td><td>0</td><td></td><td>5</td><td></td></tr> <tr><td>0</td><td>0</td><td></td><td>0</td><td>175</td></tr> <tr><td></td><td>0</td><td>0</td><td>0</td><td></td></tr> <tr><td></td><td>0</td><td></td><td>0</td><td></td></tr> </table>		185		115			10	0	175		15	0	305	115	120		0		5		0	0		0	175		0	0	0			0		0	
	185		115																																
	10	0	175																																
15	0	305	115	120																															
	0		5																																
0	0		0	175																															
	0	0	0																																
	0		0																																
14 Berkeley Ave 2020 SB I-5 Ramps																																			
<table border="1"> <tr><td></td><td>280</td><td></td><td>565</td><td></td></tr> <tr><td></td><td>195</td><td>85</td><td>0</td><td></td></tr> <tr><td>745</td><td>0</td><td>1,775</td><td>5</td><td>390</td></tr> <tr><td></td><td>0</td><td></td><td>5</td><td></td></tr> <tr><td>0</td><td>0</td><td></td><td>380</td><td>0</td></tr> <tr><td></td><td>545</td><td>560</td><td>0</td><td></td></tr> <tr><td></td><td>465</td><td></td><td>1,105</td><td></td></tr> </table>		280		565			195	85	0		745	0	1,775	5	390		0		5		0	0		380	0		545	560	0			465		1,105	
	280		565																																
	195	85	0																																
745	0	1,775	5	390																															
	0		5																																
0	0		380	0																															
	545	560	0																																
	465		1,105																																

Berkeley St Union Ave																																			
<table border="1"> <tr><td></td><td>370</td><td></td><td>145</td><td></td></tr> <tr><td></td><td>0</td><td>345</td><td>25</td><td></td></tr> <tr><td>0</td><td>0</td><td>965</td><td>35</td><td>240</td></tr> <tr><td></td><td>0</td><td></td><td>5</td><td></td></tr> <tr><td>10</td><td>10</td><td></td><td>200</td><td>260</td></tr> <tr><td></td><td>0</td><td>110</td><td>235</td><td></td></tr> <tr><td></td><td>555</td><td></td><td>345</td><td></td></tr> </table>		370		145			0	345	25		0	0	965	35	240		0		5		10	10		200	260		0	110	235			555		345	
	370		145																																
	0	345	25																																
0	0	965	35	240																															
	0		5																																
10	10		200	260																															
	0	110	235																																
	555		345																																
Berkeley St SB I-5 Ramps																																			
<table border="1"> <tr><td></td><td>555</td><td></td><td>345</td><td></td></tr> <tr><td></td><td>240</td><td>315</td><td>0</td><td></td></tr> <tr><td>0</td><td></td><td>1,605</td><td>80</td><td>435</td></tr> <tr><td></td><td>0</td><td></td><td>5</td><td></td></tr> <tr><td>0</td><td>0</td><td></td><td>350</td><td>0</td></tr> <tr><td></td><td>350</td><td>265</td><td>0</td><td></td></tr> <tr><td></td><td>665</td><td></td><td>615</td><td></td></tr> </table>		555		345			240	315	0		0		1,605	80	435		0		5		0	0		350	0		350	265	0			665		615	
	555		345																																
	240	315	0																																
0		1,605	80	435																															
	0		5																																
0	0		350	0																															
	350	265	0																																
	665		615																																

13 Berkeley Ave 2040 Union Ave																																			
<table border="1"> <tr><td></td><td>185</td><td></td><td>65</td><td></td></tr> <tr><td></td><td>5</td><td>5</td><td>175</td><td></td></tr> <tr><td>10</td><td>5</td><td>315</td><td>60</td><td>65</td></tr> <tr><td></td><td>0</td><td></td><td>5</td><td></td></tr> <tr><td>5</td><td>0</td><td></td><td>0</td><td>235</td></tr> <tr><td></td><td>0</td><td>0</td><td>60</td><td></td></tr> <tr><td></td><td>5</td><td></td><td>60</td><td></td></tr> </table>		185		65			5	5	175		10	5	315	60	65		0		5		5	0		0	235		0	0	60			5		60	
	185		65																																
	5	5	175																																
10	5	315	60	65																															
	0		5																																
5	0		0	235																															
	0	0	60																																
	5		60																																
14 Berkeley Ave 2040 SB I-5 Ramps																																			
<table border="1"> <tr><td></td><td>310</td><td></td><td>340</td><td></td></tr> <tr><td></td><td>215</td><td>95</td><td>0</td><td></td></tr> <tr><td>755</td><td>0</td><td>1,475</td><td>0</td><td>290</td></tr> <tr><td></td><td>0</td><td></td><td>5</td><td></td></tr> <tr><td>0</td><td>0</td><td></td><td>285</td><td>0</td></tr> <tr><td></td><td>535</td><td>340</td><td>0</td><td></td></tr> <tr><td></td><td>380</td><td></td><td>875</td><td></td></tr> </table>		310		340			215	95	0		755	0	1,475	0	290		0		5		0	0		285	0		535	340	0			380		875	
	310		340																																
	215	95	0																																
755	0	1,475	0	290																															
	0		5																																
0	0		285	0																															
	535	340	0																																
	380		875																																

PM PEAK HOUR TURNING MOVEMENT SUMMARY

Post-processed Data
from Mesoscopic Model

	Post-Processed EXISTING 2013 Model Volumes Peak Hour	Post-Processed NO BUILD P1 2020 Volumes Peak Hour	Post-Processed BUILD RB_sbGLC_noHOV_2020 Volumes Peak Hour	Post-Processed NO BUILD P1 2040 Volumes Peak Hour	Post-Processed BUILD RB_sbGLC_noHOV_2040 Volume Peak Hour																																																																																																																																																																																																																																																																					
<table border="1"> <tr><th colspan="2">North-South Street</th><th colspan="2">Berkeley St</th></tr> <tr><th colspan="2">East-West Street</th><th colspan="2">NB I-5 Ramps</th></tr> <tr><td>Count Date:</td><td>3/5/2013</td><td>16</td><td>Berkeley St</td></tr> <tr><td>Count Source:</td><td>TC2</td><td>2020</td><td>NB I-5 Ramps</td></tr> <tr><td>EB</td><td>WB</td><td>NB</td><td>SB</td><td>Total</td><td></td><td></td><td></td><td></td></tr> <tr><td>%HV</td><td>0%</td><td>1%</td><td>1%</td><td></td><td></td><td></td><td></td><td></td></tr> <tr><td>PHF</td><td></td><td></td><td></td><td>0.97</td><td></td><td></td><td></td><td></td></tr> <tr><td colspan="2">Peak Hour Used:</td><td></td><td></td><td></td><td></td><td></td><td></td><td></td></tr> <tr><td>From</td><td>1630</td><td>To</td><td>1730</td><td></td><td></td><td></td><td></td><td></td></tr> </table>	North-South Street		Berkeley St		East-West Street		NB I-5 Ramps		Count Date:	3/5/2013	16	Berkeley St	Count Source:	TC2	2020	NB I-5 Ramps	EB	WB	NB	SB	Total					%HV	0%	1%	1%						PHF				0.97					Peak Hour Used:									From	1630	To	1730						<table border="1"> <tr><td>0</td><td>115</td><td>425</td><td>300</td><td>125</td><td>665</td><td>0</td></tr> <tr><td></td><td>5</td><td></td><td>2,315</td><td></td><td></td><td></td></tr> <tr><td>140</td><td>20</td><td></td><td></td><td></td><td></td><td>1,330</td></tr> <tr><td></td><td></td><td>320</td><td>550</td><td>1,200</td><td>1,750</td><td></td></tr> </table>	0	115	425	300	125	665	0		5		2,315				140	20					1,330			320	550	1,200	1,750		<table border="1"> <tr><td>0</td><td>85</td><td>675</td><td>485</td><td>190</td><td>565</td><td>0</td></tr> <tr><td></td><td>5</td><td></td><td>2,445</td><td></td><td></td><td></td></tr> <tr><td>95</td><td>5</td><td></td><td></td><td></td><td></td><td>1,390</td></tr> <tr><td></td><td></td><td>490</td><td>480</td><td>1,195</td><td>1,675</td><td></td></tr> </table>	0	85	675	485	190	565	0		5		2,445				95	5					1,390			490	480	1,195	1,675		<table border="1"> <tr><td>0</td><td>225</td><td>465</td><td>460</td><td>5</td><td>1,105</td><td>0</td></tr> <tr><td></td><td>0</td><td></td><td>3,275</td><td></td><td></td><td></td></tr> <tr><td>625</td><td>400</td><td></td><td></td><td></td><td></td><td>1,310</td></tr> <tr><td></td><td></td><td>860</td><td>880</td><td>1,305</td><td>2,165</td><td></td></tr> </table>	0	225	465	460	5	1,105	0		0		3,275				625	400					1,310			860	880	1,305	2,165		<table border="1"> <tr><td>115</td><td>0</td><td>665</td><td>430</td><td>235</td><td>615</td><td>0</td></tr> <tr><td></td><td>5</td><td></td><td>2,505</td><td></td><td></td><td></td></tr> <tr><td>35</td><td></td><td></td><td></td><td></td><td></td><td>1,425</td></tr> <tr><td></td><td></td><td>465</td><td>500</td><td>1,185</td><td>1,685</td><td></td></tr> </table>	115	0	665	430	235	615	0		5		2,505				35						1,425			465	500	1,185	1,685		<table border="1"> <tr><td>0</td><td>140</td><td>380</td><td>380</td><td>0</td><td>875</td><td>0</td></tr> <tr><td></td><td>5</td><td></td><td>2,525</td><td></td><td></td><td></td></tr> <tr><td>235</td><td>90</td><td></td><td></td><td></td><td></td><td>1,180</td></tr> <tr><td></td><td></td><td>470</td><td>735</td><td>1,175</td><td>1,910</td><td></td></tr> </table>	0	140	380	380	0	875	0		5		2,525				235	90					1,180			470	735	1,175	1,910																																																													
North-South Street		Berkeley St																																																																																																																																																																																																																																																																								
East-West Street		NB I-5 Ramps																																																																																																																																																																																																																																																																								
Count Date:	3/5/2013	16	Berkeley St																																																																																																																																																																																																																																																																							
Count Source:	TC2	2020	NB I-5 Ramps																																																																																																																																																																																																																																																																							
EB	WB	NB	SB	Total																																																																																																																																																																																																																																																																						
%HV	0%	1%	1%																																																																																																																																																																																																																																																																							
PHF				0.97																																																																																																																																																																																																																																																																						
Peak Hour Used:																																																																																																																																																																																																																																																																										
From	1630	To	1730																																																																																																																																																																																																																																																																							
0	115	425	300	125	665	0																																																																																																																																																																																																																																																																				
	5		2,315																																																																																																																																																																																																																																																																							
140	20					1,330																																																																																																																																																																																																																																																																				
		320	550	1,200	1,750																																																																																																																																																																																																																																																																					
0	85	675	485	190	565	0																																																																																																																																																																																																																																																																				
	5		2,445																																																																																																																																																																																																																																																																							
95	5					1,390																																																																																																																																																																																																																																																																				
		490	480	1,195	1,675																																																																																																																																																																																																																																																																					
0	225	465	460	5	1,105	0																																																																																																																																																																																																																																																																				
	0		3,275																																																																																																																																																																																																																																																																							
625	400					1,310																																																																																																																																																																																																																																																																				
		860	880	1,305	2,165																																																																																																																																																																																																																																																																					
115	0	665	430	235	615	0																																																																																																																																																																																																																																																																				
	5		2,505																																																																																																																																																																																																																																																																							
35						1,425																																																																																																																																																																																																																																																																				
		465	500	1,185	1,685																																																																																																																																																																																																																																																																					
0	140	380	380	0	875	0																																																																																																																																																																																																																																																																				
	5		2,525																																																																																																																																																																																																																																																																							
235	90					1,180																																																																																																																																																																																																																																																																				
		470	735	1,175	1,910																																																																																																																																																																																																																																																																					
<table border="1"> <tr><th colspan="2">North-South Street</th><th colspan="2">Gravelly-Thorne Connector Ln</th></tr> <tr><th colspan="2">East-West Street</th><th colspan="2">Union Ave</th></tr> <tr><td colspan="2">NEW INTERSECTION BUILD ALTERNATIVE</td><td></td><td></td><td></td><td></td><td></td><td></td><td></td></tr> </table>	North-South Street		Gravelly-Thorne Connector Ln		East-West Street		Union Ave		NEW INTERSECTION BUILD ALTERNATIVE											<table border="1"> <tr><td>180</td><td>110</td><td>115</td><td>0</td><td>0</td><td>120</td><td>75</td></tr> <tr><td></td><td>0</td><td></td><td>300</td><td></td><td></td><td>10</td></tr> <tr><td>110</td><td>0</td><td></td><td></td><td></td><td></td><td>65</td></tr> <tr><td></td><td></td><td>0</td><td>0</td><td>0</td><td>0</td><td>0</td></tr> </table>	180	110	115	0	0	120	75		0		300			10	110	0					65			0	0	0	0	0		<table border="1"> <tr><td>180</td><td>30</td><td>100</td><td>0</td><td>0</td><td>190</td><td>240</td></tr> <tr><td></td><td>0</td><td></td><td>370</td><td></td><td></td><td>160</td></tr> <tr><td>30</td><td>0</td><td></td><td></td><td></td><td></td><td>80</td></tr> <tr><td></td><td></td><td>0</td><td>0</td><td>0</td><td>0</td><td>0</td></tr> </table>	180	30	100	0	0	190	240		0		370			160	30	0					80			0	0	0	0	0																																																																																																																																																																																												
North-South Street		Gravelly-Thorne Connector Ln																																																																																																																																																																																																																																																																								
East-West Street		Union Ave																																																																																																																																																																																																																																																																								
NEW INTERSECTION BUILD ALTERNATIVE																																																																																																																																																																																																																																																																										
180	110	115	0	0	120	75																																																																																																																																																																																																																																																																				
	0		300			10																																																																																																																																																																																																																																																																				
110	0					65																																																																																																																																																																																																																																																																				
		0	0	0	0	0																																																																																																																																																																																																																																																																				
180	30	100	0	0	190	240																																																																																																																																																																																																																																																																				
	0		370			160																																																																																																																																																																																																																																																																				
30	0					80																																																																																																																																																																																																																																																																				
		0	0	0	0	0																																																																																																																																																																																																																																																																				
<table border="1"> <tr><th colspan="2">North-South Street</th><th colspan="2">Thorne Ln</th></tr> <tr><th colspan="2">East-West Street</th><th colspan="2">Union Ave</th></tr> <tr><td>Count Date:</td><td>3/5/2013</td><td>14</td><td>Thorne Ln</td></tr> <tr><td>Count Source:</td><td>TC2</td><td>2014</td><td>Union Ave</td></tr> <tr><td>EB</td><td>WB</td><td>NB</td><td>SB</td><td>Total</td><td></td><td></td><td></td><td></td></tr> <tr><td>%HV</td><td>0%</td><td>1%</td><td>0%</td><td></td><td></td><td></td><td></td><td></td></tr> <tr><td>PHF</td><td></td><td></td><td></td><td>0.96</td><td></td><td></td><td></td><td></td></tr> <tr><td colspan="2">Peak Hour Used:</td><td></td><td></td><td></td><td></td><td></td><td></td><td></td></tr> <tr><td>From</td><td>1630</td><td>To</td><td>1730</td><td></td><td></td><td></td><td></td><td></td></tr> </table>	North-South Street		Thorne Ln		East-West Street		Union Ave		Count Date:	3/5/2013	14	Thorne Ln	Count Source:	TC2	2014	Union Ave	EB	WB	NB	SB	Total					%HV	0%	1%	0%						PHF				0.96					Peak Hour Used:									From	1630	To	1730						<table border="1"> <tr><td>170</td><td>0</td><td>5</td><td>270</td><td>100</td><td>275</td><td>0</td></tr> <tr><td></td><td></td><td></td><td>720</td><td></td><td></td><td></td></tr> <tr><td>180</td><td>180</td><td></td><td></td><td></td><td></td><td>0</td></tr> <tr><td></td><td></td><td>165</td><td>100</td><td></td><td></td><td></td></tr> <tr><td></td><td></td><td>450</td><td>265</td><td></td><td></td><td></td></tr> </table>	170	0	5	270	100	275	0				720				180	180					0			165	100						450	265				<table border="1"> <tr><td>335</td><td>0</td><td>5</td><td>285</td><td>0</td><td>290</td><td>0</td></tr> <tr><td></td><td></td><td></td><td>1,090</td><td></td><td></td><td></td></tr> <tr><td>190</td><td>190</td><td></td><td></td><td></td><td></td><td>0</td></tr> <tr><td></td><td></td><td>330</td><td>280</td><td>0</td><td></td><td></td></tr> <tr><td></td><td></td><td>475</td><td>610</td><td></td><td></td><td></td></tr> </table>	335	0	5	285	0	290	0				1,090				190	190					0			330	280	0					475	610				<table border="1"> <tr><td>0</td><td>0</td><td>860</td><td>855</td><td>5</td><td>320</td><td>120</td></tr> <tr><td></td><td></td><td></td><td>1,405</td><td></td><td></td><td>5</td></tr> <tr><td>0</td><td></td><td></td><td></td><td></td><td></td><td>115</td></tr> <tr><td></td><td></td><td>0</td><td>315</td><td>110</td><td></td><td></td></tr> <tr><td></td><td></td><td>970</td><td>425</td><td></td><td></td><td></td></tr> </table>	0	0	860	855	5	320	120				1,405			5	0						115			0	315	110					970	425				<table border="1"> <tr><td>0</td><td>0</td><td>305</td><td>300</td><td>0</td><td>150</td><td>0</td></tr> <tr><td></td><td></td><td></td><td>835</td><td></td><td></td><td></td></tr> <tr><td>160</td><td></td><td></td><td></td><td></td><td></td><td>0</td></tr> <tr><td></td><td></td><td>220</td><td>150</td><td>0</td><td></td><td></td></tr> <tr><td></td><td></td><td>460</td><td>370</td><td></td><td></td><td></td></tr> </table>	0	0	305	300	0	150	0				835				160						0			220	150	0					460	370				<table border="1"> <tr><td>0</td><td>0</td><td>515</td><td>490</td><td>25</td><td>395</td><td>190</td></tr> <tr><td></td><td></td><td></td><td>1,140</td><td></td><td></td><td>35</td></tr> <tr><td>0</td><td></td><td></td><td></td><td></td><td></td><td>155</td></tr> <tr><td></td><td></td><td>0</td><td>360</td><td>75</td><td></td><td></td></tr> <tr><td></td><td></td><td>645</td><td>435</td><td></td><td></td><td></td></tr> </table>	0	0	515	490	25	395	190				1,140			35	0						155			0	360	75					645	435																												
North-South Street		Thorne Ln																																																																																																																																																																																																																																																																								
East-West Street		Union Ave																																																																																																																																																																																																																																																																								
Count Date:	3/5/2013	14	Thorne Ln																																																																																																																																																																																																																																																																							
Count Source:	TC2	2014	Union Ave																																																																																																																																																																																																																																																																							
EB	WB	NB	SB	Total																																																																																																																																																																																																																																																																						
%HV	0%	1%	0%																																																																																																																																																																																																																																																																							
PHF				0.96																																																																																																																																																																																																																																																																						
Peak Hour Used:																																																																																																																																																																																																																																																																										
From	1630	To	1730																																																																																																																																																																																																																																																																							
170	0	5	270	100	275	0																																																																																																																																																																																																																																																																				
			720																																																																																																																																																																																																																																																																							
180	180					0																																																																																																																																																																																																																																																																				
		165	100																																																																																																																																																																																																																																																																							
		450	265																																																																																																																																																																																																																																																																							
335	0	5	285	0	290	0																																																																																																																																																																																																																																																																				
			1,090																																																																																																																																																																																																																																																																							
190	190					0																																																																																																																																																																																																																																																																				
		330	280	0																																																																																																																																																																																																																																																																						
		475	610																																																																																																																																																																																																																																																																							
0	0	860	855	5	320	120																																																																																																																																																																																																																																																																				
			1,405			5																																																																																																																																																																																																																																																																				
0						115																																																																																																																																																																																																																																																																				
		0	315	110																																																																																																																																																																																																																																																																						
		970	425																																																																																																																																																																																																																																																																							
0	0	305	300	0	150	0																																																																																																																																																																																																																																																																				
			835																																																																																																																																																																																																																																																																							
160						0																																																																																																																																																																																																																																																																				
		220	150	0																																																																																																																																																																																																																																																																						
		460	370																																																																																																																																																																																																																																																																							
0	0	515	490	25	395	190																																																																																																																																																																																																																																																																				
			1,140			35																																																																																																																																																																																																																																																																				
0						155																																																																																																																																																																																																																																																																				
		0	360	75																																																																																																																																																																																																																																																																						
		645	435																																																																																																																																																																																																																																																																							
<table border="1"> <tr><th colspan="2">North-South Street</th><th colspan="2">Thorne Ln</th></tr> <tr><th colspan="2">East-West Street</th><th colspan="2">SB I-5 Ramps</th></tr> <tr><td>Count Date:</td><td>3/5/2013</td><td>15</td><td>Thorne Ln</td></tr> <tr><td>Count Source:</td><td>TC2</td><td>2014</td><td>SB I-5 Ramps</td></tr> <tr><td>EB</td><td>WB</td><td>NB</td><td>SB</td><td>Total</td><td></td><td></td><td></td><td></td></tr> <tr><td>%HV</td><td>1%</td><td>2%</td><td>1%</td><td></td><td></td><td></td><td></td><td></td></tr> <tr><td>PHF</td><td></td><td></td><td></td><td>0.98</td><td></td><td></td><td></td><td></td></tr> <tr><td colspan="2">Peak Hour Used:</td><td></td><td></td><td></td><td></td><td></td><td></td><td></td></tr> <tr><td>From</td><td>1630</td><td>To</td><td>1730</td><td></td><td></td><td></td><td></td><td></td></tr> </table>	North-South Street		Thorne Ln		East-West Street		SB I-5 Ramps		Count Date:	3/5/2013	15	Thorne Ln	Count Source:	TC2	2014	SB I-5 Ramps	EB	WB	NB	SB	Total					%HV	1%	2%	1%						PHF				0.98					Peak Hour Used:									From	1630	To	1730						<table border="1"> <tr><td>225</td><td>10</td><td>425</td><td>415</td><td>260</td><td>260</td><td>215</td><td>500</td></tr> <tr><td></td><td></td><td></td><td>1,175</td><td></td><td></td><td>10</td><td></td></tr> <tr><td>0</td><td></td><td></td><td></td><td></td><td></td><td>275</td><td>0</td></tr> <tr><td></td><td></td><td>205</td><td>45</td><td></td><td></td><td></td><td></td></tr> <tr><td></td><td></td><td>690</td><td>250</td><td></td><td></td><td></td><td></td></tr> </table>	225	10	425	415	260	260	215	500				1,175			10		0						275	0			205	45							690	250					<table border="1"> <tr><td>400</td><td>0</td><td>15</td><td>460</td><td>0</td><td>610</td><td>575</td><td>820</td></tr> <tr><td></td><td></td><td></td><td>1,705</td><td></td><td></td><td>10</td><td></td></tr> <tr><td>0</td><td></td><td></td><td></td><td></td><td></td><td>235</td><td>0</td></tr> <tr><td></td><td></td><td>375</td><td>35</td><td>0</td><td></td><td></td><td></td></tr> <tr><td></td><td></td><td>695</td><td>410</td><td></td><td></td><td></td><td></td></tr> </table>	400	0	15	460	0	610	575	820				1,705			10		0						235	0			375	35	0						695	410					<table border="1"> <tr><td>335</td><td>0</td><td>970</td><td>955</td><td>0</td><td>425</td><td>350</td><td>665</td></tr> <tr><td></td><td></td><td></td><td>2,020</td><td></td><td></td><td>10</td><td></td></tr> <tr><td>0</td><td></td><td></td><td></td><td></td><td></td><td>305</td><td>0</td></tr> <tr><td></td><td></td><td>310</td><td>75</td><td>0</td><td></td><td></td><td></td></tr> <tr><td></td><td></td><td>1,260</td><td>385</td><td></td><td></td><td></td><td></td></tr> </table>	335	0	970	955	0	425	350	665				2,020			10		0						305	0			310	75	0						1,260	385					<table border="1"> <tr><td>0</td><td>0</td><td>460</td><td>450</td><td>0</td><td>370</td><td>320</td><td>570</td></tr> <tr><td></td><td></td><td></td><td>1,435</td><td></td><td></td><td>10</td><td></td></tr> <tr><td>0</td><td></td><td></td><td></td><td></td><td></td><td>240</td><td>0</td></tr> <tr><td></td><td></td><td>355</td><td>50</td><td>0</td><td></td><td></td><td></td></tr> <tr><td></td><td></td><td>690</td><td>405</td><td></td><td></td><td></td><td></td></tr> </table>	0	0	460	450	0	370	320	570				1,435			10		0						240	0			355	50	0						690	405					<table border="1"> <tr><td>790</td><td>0</td><td>645</td><td>520</td><td>0</td><td>435</td><td>335</td><td>610</td></tr> <tr><td></td><td></td><td></td><td>2,010</td><td></td><td></td><td>10</td><td></td></tr> <tr><td>0</td><td></td><td></td><td></td><td></td><td></td><td>265</td><td>0</td></tr> <tr><td></td><td></td><td>655</td><td>100</td><td>0</td><td></td><td></td><td></td></tr> <tr><td></td><td></td><td>785</td><td>755</td><td></td><td></td><td></td><td></td></tr> </table>	790	0	645	520	0	435	335	610				2,010			10		0						265	0			655	100	0						785	755				
North-South Street		Thorne Ln																																																																																																																																																																																																																																																																								
East-West Street		SB I-5 Ramps																																																																																																																																																																																																																																																																								
Count Date:	3/5/2013	15	Thorne Ln																																																																																																																																																																																																																																																																							
Count Source:	TC2	2014	SB I-5 Ramps																																																																																																																																																																																																																																																																							
EB	WB	NB	SB	Total																																																																																																																																																																																																																																																																						
%HV	1%	2%	1%																																																																																																																																																																																																																																																																							
PHF				0.98																																																																																																																																																																																																																																																																						
Peak Hour Used:																																																																																																																																																																																																																																																																										
From	1630	To	1730																																																																																																																																																																																																																																																																							
225	10	425	415	260	260	215	500																																																																																																																																																																																																																																																																			
			1,175			10																																																																																																																																																																																																																																																																				
0						275	0																																																																																																																																																																																																																																																																			
		205	45																																																																																																																																																																																																																																																																							
		690	250																																																																																																																																																																																																																																																																							
400	0	15	460	0	610	575	820																																																																																																																																																																																																																																																																			
			1,705			10																																																																																																																																																																																																																																																																				
0						235	0																																																																																																																																																																																																																																																																			
		375	35	0																																																																																																																																																																																																																																																																						
		695	410																																																																																																																																																																																																																																																																							
335	0	970	955	0	425	350	665																																																																																																																																																																																																																																																																			
			2,020			10																																																																																																																																																																																																																																																																				
0						305	0																																																																																																																																																																																																																																																																			
		310	75	0																																																																																																																																																																																																																																																																						
		1,260	385																																																																																																																																																																																																																																																																							
0	0	460	450	0	370	320	570																																																																																																																																																																																																																																																																			
			1,435			10																																																																																																																																																																																																																																																																				
0						240	0																																																																																																																																																																																																																																																																			
		355	50	0																																																																																																																																																																																																																																																																						
		690	405																																																																																																																																																																																																																																																																							
790	0	645	520	0	435	335	610																																																																																																																																																																																																																																																																			
			2,010			10																																																																																																																																																																																																																																																																				
0						265	0																																																																																																																																																																																																																																																																			
		655	100	0																																																																																																																																																																																																																																																																						
		785	755																																																																																																																																																																																																																																																																							

PM PEAK HOUR TURNING MOVEMENT SUMMARY

Post-processed Data
from Mesoscopic Model

	Post-Processed EXISTING 2013 Model Volumes Peak Hour	Post-Processed NO BUILD P1 2020 Volumes Peak Hour	Post-Processed BUILD RB_sbGLC_noHOV_2020 Volumes Peak Hour	Post-Processed NO BUILD P1 2040 Volumes Peak Hour	Post-Processed BUILD RB_sbGLC_noHOV_2040 Volume Peak Hour
<p>North-South Street East-West Street</p> <p>Count Date: 3/5/2013</p> <p>Count Source: TC2</p> <p>EB WB NB SB Total</p> <p>%HV 3% 2% 1%</p> <p>PHF 0.98</p> <p>Peak Hour Used:</p> <p>From 1630 To 1730</p>	<p>16 Thorne Ln 2014 NB I-5 Ramps</p>	<p>20 Thorne Ln 2020 NB I-5 Ramps</p>	<p>19 Thorne Ln 2020 NB I-5 Ramps</p>	<p>Thorne Ln NB I-5 Ramps</p>	<p>19 Thorne Ln 2040 NB I-5 Ramps</p>
<p>North-South Street East-West Street</p> <p>Count Date: 3/7/2013</p> <p>Count Source: TC2</p> <p>EB WB NB SB Total</p> <p>%HV 2% 2% 2%</p> <p>PHF 0.95</p> <p>Peak Hour Used:</p> <p>From 1630 To 1730</p>	<p>17 Gravelly Lake Dr 2013 Pacific Hwy</p>	<p>21 Gravelly Lake Dr 2020 Pacific Hwy</p>	<p>21 Gravelly Lake Dr 2020 Pacific Hwy</p>	<p>Gravelly Lake Dr Pacific Hwy</p>	<p>20 Gravelly Lake Dr 2040 Pacific Hwy</p>
<p>North-South Street East-West Street</p> <p>Count Date: 3/7/2013</p> <p>Count Source: TC2</p> <p>EB WB NB SB Total</p> <p>%HV 3% 1% 1%</p> <p>PHF 0.98</p> <p>Peak Hour Used:</p> <p>From 1630 To 1730</p>	<p>18 Gravelly Lake Dr 2013 SB I-5 Ramps</p>	<p>22 Gravelly Lake Dr 2020 SB I-5 Ramps</p>	<p>22 Gravelly Lake Dr 2020 SB I-5 Ramps</p>	<p>Gravelly Lake Dr SB I-5 Ramps</p>	<p>21 Gravelly Lake Dr 2040 SB I-5 Ramps</p>
<p>North-South Street East-West Street</p> <p>Count Date: 3/7/2013</p> <p>Count Source: TC2</p> <p>EB WB NB SB Total</p> <p>%HV 1% 1% 2%</p> <p>PHF 0.93</p> <p>Peak Hour Used:</p> <p>From 1630 To 1730</p>	<p>19 Gravelly Lake Dr 2013 NB I-5 Ramps</p>	<p>23 Gravelly Lake Dr 2020 NB I-5 Ramps</p>	<p>23 Gravelly Lake Dr 2020 NB I-5 Ramps</p>	<p>Gravelly Lake Dr NB I-5 Ramps</p>	<p>22 Gravelly Lake Dr 2040 NB I-5 Ramps</p>

Appendix C
No Build Alternative
Intersection Analysis Summary

This Page Intentionally Left Blank

Intersection Analysis Summary - 2020 No Build

No.	Intersection	Control Type	Approach Road	Movement	AM PEAK HOUR					PM PEAK HOUR							
					Post-Process Volume (vph)	LOS	Delay (sec)	LOS	Delay (sec)	95th Queue (ft)	Post-Process Volume (vph)	LOS	Delay (sec)	LOS	Delay (sec)	95th Queue (ft)	
																	Approach
3	I-5 NB Ramps / Center Drive	Stop Control on EB Center Drive from Base (I-5 Off Loop Ramp as thru trips)	Overall	1,160	B	13.2				970	B	12.0					
			Center Drive EB-L	15	B	13.2	B	13.2	3	550	0.0	A	0.0				
			Center Drive EB-T														
			Center Drive EB-R														
			I-5 Off Loop Ramp NB-L		0.0	0.0	A	0.0	305	B	12.0	B	12.5	50			
			I-5 Off Loop Ramp NB-T	685													
			I-5 Off Loop Ramp NB-R														
			Center Drive SB-L		0.0	0.0			115			A	0.0				
Center Drive SB-T	460																
Center Drive SB-R																	
4	I-5 SB Ramps / Center Drive	Two-way Stop Control on Ramps	Overall	1,795	C	18.6				2,120	C	15.2					
			I-5 Off-ramp WB-L	0	C	18.6				275	C	15.2	50				
			I-5 Off-ramp WB-T	0													
			I-5 Off-ramp WB-R	295			C	18.6	70								
			Center Drive NB-L	10	0.2	0.2	A	8.5	145	1.7	A	7.7	6				
			Center Drive NB-T	690			A	0.1	710		A	0.5					
			Center Drive NB-R	0					0								
			Center Drive SB-L	0	0.0	0.0	A	0.0	115			A	0.0				
			Center Drive SB-T	460													
Center Drive SB-R	340	A	0.0	875											A	0.0	
5	Center Drive / Wilmington Drive	Signal	Overall	1,920	B	16.0				2,195	C	20.5					
			Wilmington Drive EB-L	5	B	15.8	B	15.5	7	20	B	12.6	B	12.4	10		
			Wilmington Drive EB-T	15			B	15.9	25				B	12.6	26		
			Wilmington Drive EB-R	60			B	15.9	25								
			Wilmington Drive WB-L	125	B	19.9	C	21.5	66	335	C	34.1	#208				
			Wilmington Drive WB-T	15			B	15.8	21		C	28.5	B	12.8	34		
			Wilmington Drive WB-R	35			B	15.8	21								
			Center Drive NB-L	100	B	16.6	E	68.8	#94	50	C	F	125.3	41			
			Center Drive NB-T	620			A	10.7	#185	670		C	20.7	B	15.1	#183	
			Center Drive NB-R	265			A	10.7	#185	265							
			Center Drive SB-L	60	B	14.1	E	61.8	#56	60	B	E	59.7	#52			
			Center Drive SB-T	610			A	9.4	125	595		B	15.6	B	11.2	113	
Center Drive SB-R	10	A	9.4	125			10										
6	I-5 NB Ramps / DuPont-Steilacoom Road	Signal	Overall	2,055	D	41.2				2,275	D	43.4					
			I-5 Off-ramp EB-L	370	C	26.3	E	67.8	#459	310	D	47.8	E	77.5	#425		
			I-5 Off-ramp EB-T	5			E	67.8	#459	10			E	77.5	#425		
			I-5 Off-ramp EB-R	615			A	1.0	0	200			A	0.2	0		
			Clark Road NB-L	0	E	63.0				0	D	43.7	D	50.0	#784		
			Clark Road NB-T	365			E	68.9	#443	710			D	43.7	D	50.0	#784
			Clark Road NB-R	75			C	34.1	33	210			C	22.4	73		
			Steilacoom-DuPont SB-L	215	D	49.5	C	32.7	m#142	755	D	40.3	D	40.6	m388		
			Steilacoom-DuPont SB-T	410			E	57.0	m#384	80			D	40.0	m391		
Steilacoom-DuPont SB-R	0						0										
7	I-5 SB Ramps / DuPont-Steilacoom Road	Signal	Overall	2,300	D	54.3				2,290	D	37.5					
			I-5 Off-ramp WB-L	175	E	65.7	C	29.8	175	15	D	53.0	D	53.4	33		
			I-5 Off-ramp WB-T	0									0				
			I-5 Off-ramp WB-R	655			E	75.3	#651				110	D	53.0	D	52.9
			Steilacoom-DuPont NB-L	180	E	64.2	E	64.2	m#779	525	C	21.6	C	21.6	m#969		
			Steilacoom-DuPont NB-T	555			E	64.2	m#779	495			C	21.6	C	21.6	m#969
			Steilacoom-DuPont NB-R	0						0							
			Steilacoom-DuPont SB-L	0	C	31.4				0	D	49.9					
			Steilacoom-DuPont SB-T	450			D	51.2	m234	820			D	49.9	E	69.6	#476
Steilacoom-DuPont SB-R	285	A	0.2	m0			325	A	0.3	0							

Intersection Analysis Summary - 2020 No Build

No.	Intersection	Control Type	Approach Road	Movement	AM PEAK HOUR					PM PEAK HOUR						
					Post-Process Volume (vph)	LOS	Delay (sec)	LOS	Delay (sec)	95th Queue (ft)	Post-Process Volume (vph)	LOS	Delay (sec)	LOS	Delay (sec)	95th Queue (ft)
8	DuPont-Steilacoom Road / Barksdale Avenue / Wilmington Drive	Signal	Overall		2,130	E	72.6				2,020	B	19.5			
			Barksdale Avenue	SB-L	20	D	47.0	E	61.5	43	40	C	32.2	C	34.4	62
			Barksdale Avenue	SB-T	65			D	43.7	104	85			C	31.4	121
			Barksdale Avenue	SB-R	20			D	73.7	104	25			C	31.4	121
			Steilacoom-DuPont	NB-L	240	F	74.7	D	39.7	m189	190	C	23.1	C	27.2	194
			Steilacoom-DuPont	NB-T	65			C	28.3	m41	105			C	21.3	105
			Steilacoom-DuPont	NB-R	905			F	87.3	m247	310			C	21.2	67
			Wilmington Drive	EB-L	10	B	17.6	D	38.2	25	35	A	7.5	C	30.3	52
			Wilmington Drive	EB-T	60			A	38.2	91	100			C	33.2	119
			Wilmington Drive	EB-R	80			D	0.1	0	485			A	0.5	0
			Steilacoom-DuPont	WB-L	590	F	85.1	F	85.1	#500	575	C	24.6	C	24.6	305
Steilacoom-DuPont	WB-T	60	F	85.2	#506			40	C	24.5	303					
Steilacoom-DuPont	WB-R	15	F	85.2	#506			30	C	24.5	303					
11	I-5 NB Ramps / 41st Division Drive (Main Gate)	Cloverleaf Merge / Diverge	Overall		2,310	Cloverleaf merge/diverge Not Applicable for Synchro Analysis					2,985	Cloverleaf merge/diverge Not Applicable for Synchro Analysis				
			I-5 Off Loop Ramp	EB-R	305						50					
			I-5 Off-Ramp	WB-R	75						25					
			41st Division Drive	NB-T	450						1,400					
			41st Division Drive	NB-R	260						435					
			41st Division Drive	SB-T	920						655					
			41st Division Drive	SB-R	300						420					
12	I-5 SB Ramps / 41st Division Drive (Main Gate)	Cloverleaf Merge / Diverge	Overall		2,050	Cloverleaf merge/diverge Not Applicable for Synchro Analysis					2,960	Cloverleaf merge/diverge Not Applicable for Synchro Analysis				
			I-5 Off Loop Ramp	EB-R	120						50					
			I-5 Off-ramp	WB-R	390						50					
			41st Division Drive	NB-T	320						690					
			41st Division Drive	NB-R	205						735					
			41st Division Drive	SB-T	830						1,025					
			41st Division Drive	SB-R	185						410					
13	I-5 NB Ramps / Berkeley Avenue	Signal	Overall		2,545	C	23.5				2,445	C	20.4			
			I-5 Off-ramp	EB-L	170	C	20.3	F	91.3	#262	85	E	56.9	E	60.0	124
			I-5 Off-ramp	EB-T	0			A	0.8	0	5			E	60.0	124
			I-5 Off-ramp	EB-R	620			A	0.8	0	5			A	0.0	0
			Berkeley Ave	NB-L	0	D	54.7				0	B	17.9			
			Berkeley Ave	NB-T	235			E	60.0	336	480			D	53.2	#516
			Berkeley Ave	NB-R	450			D	52.0	111	1,195			A	3.6	0
			Berkeley Ave	SB-L	55	A	5.8	A	5.8	104	190	C	21.4	C	21.4	128
			Berkeley Ave	SB-T	1,015			A	5.8	104	485			C	21.4	128
			Berkeley Ave	SB-R	0											
14	I-5 SB Ramps / Berkeley Avenue	Signal	Overall		1,675	D	42.8				1,510	C	33.9			
			I-5 Off-ramp	WB-L	905	D	44.4	D	47.9	578	405	E	63.7	E	65.0	#282
			I-5 Off-ramp	WB-T	0						5			E	63.0	#274
			I-5 Off-ramp	WB-R	140			C	29.4	45	5			C	42.6	0
			Berkeley Ave	NB-L	125	C	30.3	C	30.3	153	300	B	13.8	B	13.8	84
			Berkeley Ave	NB-T	280			C	30.3	153	265			B	13.8	84
			Berkeley Ave	NB-R	0						0					
			Berkeley Ave	SB-L	0	E	57.5				0	C	32.1			
			Berkeley Ave	SB-T	165			E	59.7	257	270			D	43.8	288
Berkeley Ave	SB-R	60	D	51.4	35			260	D	35.4	67					
15	Berkeley Avenue / Union Avenue	All-way Stop Control	Overall		790	B	11.7				860	B	14.4			
			Militia Dr	EB-L	5	A	9.9	A	9.9	2	0	A	8.8			
			Militia Dr	EB-T	5			N	9.5	-	0					
			Militia Dr	EB-R	0						5			A	8.8	0
			Union Ave	WB-L	115	B	11.1	B	12.0	15	125	B	11.1	B	11.8	20
			Union Ave	WB-T	5			A	9.0	6	5			A	8.8	4
			Union Ave	WB-R	45			A	9.0	6	30			A	8.8	4
			Berkeley Ave	NB-L	5	B	12.2	B	14.0	60	0	A	9.2			
			Berkeley Ave	NB-T	285			A	9.6	25	90			A	9.3	10
			Berkeley Ave	NB-R	200			A	9.6	25	180			A	9.2	20
			Berkeley Ave	SB-L	10	B	10.9	B	10.9	25	25	C	19.0	C	19.0	102
			Berkeley Ave	SB-T	110			B	10.9	25	400			C	19.0	102
Berkeley Ave	SB-R	5						0								

Intersection Analysis Summary - 2020 No Build

No.	Intersection	Control Type	Approach Road	Movement	AM PEAK HOUR					PM PEAK HOUR								
					Post-Process Volume (vph)	LOS	Delay (sec)	LOS	Delay (sec)	95th Queue (ft)	Post-Process Volume (vph)	LOS	Delay (sec)	LOS	Delay (sec)	95th Queue (ft)		
																	Approach	Movement
17	Berkley Avenue/ Washington Avenue	Two-way Stop Control on Washington Avenue		Overall	470	B	12.6				570	B	12.4					
			Washington Ave	EB-L	0	A	8.8				0	B	10.8					
			Washington Ave	EB-T	0						0							
			Washington Ave	EB-R	5			A	8.8	0	5			B	10.8	0		
			Washington Ave	WB-L	35	B	12.6					25	B	12.4	B	10.8	0	
			Washington Ave	WB-T	0						0							
			Washington Ave	WB-R	5			B	12.6	10	15	B			12.4	6		
			Berkeley Ave	NB-L	5	A	0.1					5	A	0.3	A	8.2	0	
			Berkeley Ave	NB-T	320						90							
			Berkeley Ave	NB-R	10			A	0.0		25					0.0		
			Berkeley Ave	SB-L	5	A	0.4					10	A	0.2	A	7.5	0	
			Berkeley Ave	SB-T	85						395					0.0		
Berkeley Ave	SB-R	0	A	0.0				0										
18	I-5 NB Ramps / Thorne Lane	Signal		Overall	1,490	D	35.8				1,930	D	38.4					
			I-5 Off-ramp	EB-L	15	D	44.9				10	D	43.7	D	43.3	31		
			I-5 Off-ramp	EB-T	0						5							
			I-5 Off-ramp	EB-R	215			D	44.3	32	175			D	43.8	64		
			Thorne Ln	NB-L	0	E	56.9				0	D	54.9					
			Thorne Ln	NB-T	355						400					E	74.0	#499
			Thorne Ln	NB-R	255			E	71.1	#482	645			D	54.9	43.1	232	
			Thorne Ln	SB-L	230	B	12.7					370	B	12.1	B	12.1	145	
			Thorne Ln	SB-T	420						325					B	12.1	145
			Thorne Ln	SB-R	0			B	12.7	m115	0							
19	I-5 SB Ramps / Thorne Lane	Signal		Overall	1,380	E	55.4				1,705	D	45.4					
			I-5 Off-ramp	WB-L	400	E	58.2				235	D	48.7					
			I-5 Off-ramp	WB-T	5						10					E	59.7	#334
			I-5 Off-ramp	WB-R	315			E	77.2	#540	575			D	48.7	44.0	121	
			Thorne Ln	NB-L	245	D	43.8					375	C	26.0	C	26.0	m150	
			Thorne Ln	NB-T	125						35					C	26.0	m150
			Thorne Ln	NB-R	0			D	43.8	m155	0							
			Thorne Ln	SB-L	0	F	102.9				0	E	56.4					
			Thorne Ln	SB-T	250						460					E	57.2	#915
			Thorne Ln	SB-R	40			F	93.3	#373	15					C	30.5	0
20	Union Ave / Union Avenue Loop	Tee with Stop Sign on Union Avenue		Overall	730	B	10.4				1,090	B	11.6					
			Union Ave	EB-L		B	10.4					B	11.6					
			Union Ave	EB-T														
			Union Ave	EB-R	125			B	10.4	15	190			B	11.6	20		
			Thorne Ln	NB-L	230	-	4.4				330	-	4.8					
			Thorne Ln	NB-T	210						280					A	8.9	20
			Thorne Ln	NB-R	0			A	0.0	-	0					A	0.0	
			Thorne Ln	SB-L	0	-	0.0				0	-	0.0					
Thorne Ln	SB-T	165						285										
Thorne Ln	SB-R	0	-	0.0	-			-	5									
22	I-5 NB Ramps / Gravelly Lake Drive	Signal		Overall	1,355	C	27.8				1,695	D	41.6					
			I-5 Off-ramp	EB-L	460	D	48.7				745	E	64.6	E	65.1	#714		
			I-5 Off-ramp	EB-T	0						5					E	64.1	#701
			I-5 Off-ramp	EB-R	110			D	43.8	#309	65					E	64.1	#701
			Gravelly Lk Dr	NB-L	0	D	48.6				0	E	67.3					
			Gravelly Lk Dr	NB-T	130						205					E	67.3	178
			Gravelly Lk Dr	NB-R	40			D	48.6	93	45					E	67.3	178
			Gravelly Lk Dr	SB-L	580	A	2.7				560	A	1.7					
			Gravelly Lk Dr	SB-T	35						70					A	1.9	m1
			Gravelly Lk Dr	SB-R	0			A	0.1	m0	0					A	0.1	m0

Intersection Analysis Summary - 2020 No Build

No.	Intersection	Control Type	Approach Road	Movement	AM PEAK HOUR					PM PEAK HOUR						
					Post-Process Volume (vph)	LOS	Delay (sec)	LOS	Delay (sec)	95th Queue (ft)	Post-Process Volume (vph)	LOS	Delay (sec)	LOS	Delay (sec)	95th Queue (ft)
23	I-5 SB Ramps / Gravelly Lake Drive	Signal	Overall	2,120	D	39.3				2,480	D	37.2				
			I-5 Off-ramp WB-L	5	D	48.1	D	46.1	15	10	E	62.7	E	61.0	29	
			I-5 Off-ramp WB-T	0					0	E			62.7	103		
			I-5 Off-ramp WB-R	355			D	48.1	91	340			E	62.7	103	
			Gravelly Lk Dr NB-L	60	A	7.0	A	7.0	44	40	A	8.4	A	8.4	86	
			Gravelly Lk Dr NB-T	510			A	7.0	44	910			A	8.4	86	
			Gravelly Lk Dr NB-R	0					0							
			Gravelly Lk Dr SB-L	0	D	52.7	E	56.6	#764	620	D	52.8	E	57.4	#894	
			Gravelly Lk Dr SB-T	610			D	48.5	259	560			D	47.7	408	
Gravelly Lk Dr SB-R	580															
25	Gravelly Lake Drive / Pacific Highway	Signal	Overall	2,370	C	33.0				2,840	D	37.1				
			Pacific Hwy WB-L	90	D	53.2	D	54.1	63	250	E	68.3	E	71.1	175	
			Pacific Hwy WB-T	0					0	E			68.3			
			Pacific Hwy WB-R	125			D	52.5	60	150			E	63.5	132	
			Gravelly Lk Dr NB-L	0	D	47.5	D	47.9	361	1,125	B	13.7	B	14.8	174	
			Gravelly Lk Dr NB-T	825			D	40.1	m19	125			A	4.1	m7	
			Gravelly Lk Dr NB-R	40												
			Gravelly Lk Dr SB-L	190	C	19.8	B	14.9	138	260	D	51.2	D	41.0	295	
			Gravelly Lk Dr SB-T	1,100			C	20.7	437	930			D	54.1	542	
Gravelly Lk Dr SB-R	0															

Note: For Two-way Stop Control IntersectionS - Overall LOS and delay is based on worse approach/movement
 Signalized and Non-signalized intersections analyzed with Synchro software
 Roundabout intersection analyzed with Sidra software

Intersection Analysis Summary - 2040 No Build

No.	Intersection	Control Type	Approach Road	Movement	AM PEAK HOUR					PM PEAK HOUR						
					Post-Process Volume (vph)	LOS	Delay (sec)	LOS	Delay (sec)	95th Queue (ft)	Post-Process Volume (vph)	LOS	Delay (sec)	LOS	Delay (sec)	95th Queue (ft)
3	I-5 NB Ramps / Center Drive	Stop Control on EB Center Drive from Base (I-5 Off Loop Ramp as thru trips)	Overall	1,335	B	12.7				765	B	12.2				
			Center Drive EB-L	20	B	12.7	B	12.7	3	315	B	12.2	B	12.2	50	
			Center Drive EB-T													
			Center Drive EB-R													
			I-5 Off Loop Ramp NB-L		A	0.0					335	A	0.0	A	0.0	
			I-5 Off Loop Ramp NB-T	890			A	0.0								
			I-5 Off Loop Ramp NB-R													
			Center Drive SB-L		A	0.0					115	A	0.0			
Center Drive SB-T	425															
Center Drive SB-R																
4	I-5 SB Ramps / Center Drive	Two-way Stop Control on Ramps	Overall	2,085	E	35.0				1,935	B	13.2				
			I-5 Off-ramp WB-L	0	E	35.0	A	0.0		0	B	13.2	A	0.0		
			I-5 Off-ramp WB-T	0												
			I-5 Off-ramp WB-R	345			E	35.0	150	295			B	13.2	40	
			Center Drive NB-L	10	A	0.2	A	8.4		145	A	2.0	A	7.7	6	
			Center Drive NB-T	900			A	0.1		505			A	0.3		
			Center Drive NB-R	0						0						
			Center Drive SB-L	0	A	0.0				0	A	0.0	A	0.0		
			Center Drive SB-T	425			A	0.0		115						
			Center Drive SB-R	405			A	0.0		875						
5	Center Drive / Wilmington Drive	Signal	Overall	2,250	C	21.7				2,015	C	20.2				
			Wilmington Drive EB-L	5	B	15.1	B	14.7	7	10	B	12.4	B	12.2	10	
			Wilmington Drive EB-T	20			B	15.1	28	20			B	12.5	28	
			Wilmington Drive EB-R	75			B	15.1	28	75			B	12.5	28	
			Wilmington Drive WB-L	170	C	24.3	C	27.0	89	345	C	30.6	D	36.6	#219	
			Wilmington Drive WB-T	15			B	14.9	21	25			B	12.6	32	
			Wilmington Drive WB-R	35			B	14.9	21	90			B	12.6	32	
			Center Drive NB-L	105	C	23.4	F	93.7	#101	50	B	16.4	E	71.9	40	
			Center Drive NB-T	710			B	16.9	#284	440			B	12.7	95	
			Center Drive NB-R	430			B	16.9	#284	310			B	12.7	95	
			Center Drive SB-L	90	B	18.8	E	76.3	#91	70	B	19.0	F	80.2	#62	
			Center Drive SB-T	585			B	10.1	122	570			B	11.6	11	
			Center Drive SB-R	10			B	10.1	122	10			B	11.6	11	
6	I-5 NB Ramps / DuPont-Steilacoom Road	Signal	Overall	1,885	F	89.9				2,175	F	90.7				
			I-5 Off-ramp EB-L	400	C	29.4	E	56.5	#324	400	F	90.8	F	92.9	#499	
			I-5 Off-ramp EB-T	5			E	56.5	#324	10			F	92.9	#499	
			I-5 Off-ramp EB-R	380			A	0.5	0	10			A	0.0	0	
			Clark Road NB-L	0	C	27.8				0	D	44.2	D	51.1	#693	
			Clark Road NB-T	400			C	30.2	236	715			D	44.2		
			Clark Road NB-R	80			B	16.0	21	205			C	20.1	53	
			Steilacoom-DuPont SB-L	205	F	214.6	D	43.6	#198	730	F	141.8	F	143.1	m#525	
			Steilacoom-DuPont SB-T	415			F	286.9	#512	105			F	140.5	m#525	
Steilacoom-DuPont SB-R	0															
7	I-5 SB Ramps / DuPont-Steilacoom Road	Signal	Overall	2,520	F	152.6				2,635	D	48.5				
			I-5 Off-ramp WB-L	165	F	337.0	C	21.5	115	25	D	45.9	D	46.7	43	
			I-5 Off-ramp WB-T	0						0						
			I-5 Off-ramp WB-R	785			F	403.2	#660	130			D	45.8	56	
			Steilacoom-DuPont NB-L	175	E	71.6	E	71.6	m#409	540	E	76.1	E	76.1	m#1033	
			Steilacoom-DuPont NB-T	625			E	71.6	m#409	575						
			Steilacoom-DuPont NB-R	0						0						
			Steilacoom-DuPont SB-L	0	A	9.4				0	C	26.2				
			Steilacoom-DuPont SB-T	455			B	15.6	112	810			D	43.7	#358	
Steilacoom-DuPont SB-R	315	A	0.4	0			555	A	0.7	0						

Intersection Analysis Summary - 2040 No Build

No.	Intersection	Control Type	Approach Road	Movement	AM PEAK HOUR					PM PEAK HOUR						
					Post-Process Volume (vph)	LOS	Delay (sec)	LOS	Delay (sec)	95th Queue (ft)	Post-Process Volume (vph)	LOS	Delay (sec)	LOS	Delay (sec)	95th Queue (ft)
8	DuPont-Steilacoom Road / Barksdale Avenue / Wilmington Drive	Signal		Overall	2,490	F	125.0				2,420	C	20.9			
			Barksdale Avenue	SB-L	25	D	37.5	D	44.6	42	50	C	33.2	C	35.3	62
			Barksdale Avenue	SB-T	75			C	35.7	105	100			C	32.3	113
			Barksdale Avenue	SB-R	25			C	35.7	105	20			C	32.3	113
			Steilacoom-DuPont	NB-L	265	F	166.6	C	31.1	248	180	C	25.8	C	31.0	159
			Steilacoom-DuPont	NB-T	75			B	17.7	69	90			C	23.5	80
			Steilacoom-DuPont	NB-R	1,070			F	210.6	#824	435			C	24.1	73
			Wilmington Drive	EB-L	15	C	23.9	C	31.2	28	25	A	7.9	C	26.3	35
			Wilmington Drive	EB-T	165			D	39.8	175	180			C	31.6	168
			Wilmington Drive	EB-R	115			A	0.1	0	675			A	0.9	0
Steilacoom-DuPont	WB-L	580	F	97.7	F	100.5	#473	590	C	29.7	C	29.6	#350			
Steilacoom-DuPont	WB-T	60			C	94.8	#469	50			C	29.8	#356			
11	I-5 NB Ramps / 41st Division Drive (Main Gate)	Cloverleaf Merge / Diverge		Overall	2,380	Cloverleaf merge/diverge Not Applicable for Synchro Analysis					2,880	Cloverleaf merge/diverge Not Applicable for Synchro Analysis				
			I-5 Off Loop Ramp	EB-R	355						45					
			I-5 Off-Ramp	WB-R	135						50					
			41st Division Drive	NB-T	515						1,270					
			41st Division Drive	NB-R	305						440					
			41st Division Drive	SB-T	855						620					
			41st Division Drive	SB-R	215						455					
12	I-5 SB Ramps / 41st Division Drive (Main Gate)	Cloverleaf Merge / Diverge		Overall	2,000	Cloverleaf merge/diverge Not Applicable for Synchro Analysis					2,950	Cloverleaf merge/diverge Not Applicable for Synchro Analysis				
			I-5 Off Loop Ramp	EB-R	290						180					
			I-5 Off-ramp	WB-R	75						100					
			41st Division Drive	NB-T	405						630					
			41st Division Drive	NB-R	245						690					
			41st Division Drive	SB-T	780						895					
			41st Division Drive	SB-R	205						455					
13	I-5 NB Ramps / Berkeley Avenue	Signal		Overall	2,610	B	12.9				2,505	B	16.3			
			I-5 Off-ramp	EB-L	205	C	20.1	E	78.1	#286	115	D	38.1	D	49.3	157
			I-5 Off-ramp	EB-T	0			A	0.8	0	5			A	0.0	0
			I-5 Off-ramp	EB-R	615	C	20.0	A	0.6	0	35	B	17.0	A	4.7	0
			Berkeley Ave	NB-L	0			E	56.4	#361	500			D	46.2	#562
			Berkeley Ave	NB-T	280			A	0.6	0	1,185			A	4.7	0
			Berkeley Ave	NB-R	525	A	1.0	A	1.0	21	235	A	9.3	A	9.3	80
			Berkeley Ave	SB-L	70			A	1.0	21	430			A	9.3	80
			Berkeley Ave	SB-T	915			A	1.0	21	430			A	9.3	80
Berkeley Ave	SB-R	0														
14	I-5 SB Ramps / Berkeley Avenue	Signal		Overall	1,790	D	38.4				1,605	C	27.6			
			I-5 Off-ramp	WB-L	825	D	47.1	D	52.1	#505	350	D	47.5	D	50.4	#263
			I-5 Off-ramp	WB-T	0			C	29.1	49	80			D	50.4	#254
			I-5 Off-ramp	WB-R	235	B	16.3	B	16.3	105	350	A	6.7	A	6.7	32
			Berkeley Ave	NB-L	120			B	16.3	105	265			A	6.7	32
			Berkeley Ave	NB-T	365			B	16.3	105	265			A	6.7	32
			Berkeley Ave	NB-R	0	D	44.8				0	D	35.1			
			Berkeley Ave	SB-L	0			D	47.7	201	315			D	39.1	#367
			Berkeley Ave	SB-T	160			D	39.4	43	240			C	29.7	66
Berkeley Ave	SB-R	85														
15	Berkeley Avenue / Union Avenue	All-way Stop Control		Overall	920	C	15.2				965	C	19.6			
			Militia Dr	EB-L	5	B	10.3	B	10.3	10	0	A	10.0			
			Militia Dr	EB-T	5			B	10.3	10	0			A	10.0	0
			Militia Dr	EB-R	0						10			A	10.0	0
			Union Ave	WB-L	120	B	11.8	B	12.8	61	200	C	16.1	C	17.4	70
			Union Ave	WB-T	5			A	9.4	17	5			A	9.6	12
			Union Ave	WB-R	45						35			A	9.6	12
			Berkeley Ave	NB-L	5	C	17.1	C	20.9	111	0	B	12.3	B	11.1	38
			Berkeley Ave	NB-T	385			A	9.9	18	110			B	12.9	23
			Berkeley Ave	NB-R	210						235					
			Berkeley Ave	SB-L	10	B	11.7	B	11.7	39	25	D	29.0	D	29.0	127
Berkeley Ave	SB-T	125						345	D	29.0	127					
Berkeley Ave	SB-R	5						0								

Intersection Analysis Summary - 2040 No Build

No.	Intersection	Control Type	Approach Road	Movement	AM PEAK HOUR					PM PEAK HOUR								
					Post-Process Volume (vph)	LOS	Delay (sec)	LOS	Delay (sec)	95th Queue (ft)	Post-Process Volume (vph)	LOS	Delay (sec)	LOS	Delay (sec)	95th Queue (ft)		
																	Approach	Movement
17	Berklely Avenue/ Washington Avenue	Two-way Stop Control on Washington Avenue	Overall	590	B	14.3				520	B	12.2						
			Washington Ave EB-L															
			Washington Ave EB-T		A	8.8						B	10.4					
			Washington Ave EB-R	5			A	8.8	0	5			B	10.4	0			
			Washington Ave WB-L	40			B	14.3	8	25				B	12.2	5		
			Washington Ave WB-T															
			Washington Ave WB-R	10			B	14.3	8									
			Berkeley Ave NB-L	5						5					A	8.0		
			Berkeley Ave NB-T	415				0.1		340						0.0		
			Berkeley Ave NB-R	15														
			Berkeley Ave SB-L	5						5					A	7.5		
Berkeley Ave SB-T	95				0.4		95						0.0					
Berkeley Ave SB-R							45						0.0					
18	I-5 NB Ramps / Thorne Lane	Signal	Overall	1,735	C	31.7				1,820	C	34.8						
			I-5 Off-ramp EB-L	10			D	48.1	25	10			D	48.3	32			
			I-5 Off-ramp EB-T	0			D	48.5		5			D	48.8	32			
			I-5 Off-ramp EB-R	225			D	48.5	66	320			D	48.9	78			
			Thorne Ln NB-L	0						0								
			Thorne Ln NB-T	445			D	47.0	E	60.5	#596	395		D	52.4	E	72.0	#559
			Thorne Ln NB-R	345					C	29.7	101	400			C	33.1	92	
			Thorne Ln SB-L	275							355							
			Thorne Ln SB-T	435			A	9.1	A	9.1	m90	335		A	7.6	A	7.6	m97
Thorne Ln SB-R	0							0										
19	I-5 SB Ramps / Thorne Lane	Signal	Overall	1,555	E	56.0				1,435	D	45.0						
			I-5 Off-ramp WB-L	395			E	101.0	#594	240			F	86.7	#397			
			I-5 Off-ramp WB-T	5			E	101.0	#594	10			F	86.7	#397			
			I-5 Off-ramp WB-R	340			C	32.9	69	320			D	39.3	76			
			Thorne Ln NB-L	325			A	4.5	m55	355			A	4.7	m51			
			Thorne Ln NB-T	130			A	4.5	m55	50			A	4.7	m51			
			Thorne Ln NB-R	0						0								
			Thorne Ln SB-L	0						0								
			Thorne Ln SB-T	315			F	92.8	F	101.2	#489	450		E	61.7	E	62.5	#612
Thorne Ln SB-R	45					C	34.1	4	10			C	24.5	0				
20	Union Ave / Union Avenue Loop	Tee with Stop Sign on Union Avenue	Overall	830	B	11.2				835	B	12.8						
			Union Ave EB-L															
			Union Ave EB-T				B	11.2					B	12.8				
			Union Ave EB-R	140			B	11.2	20	160				B	12.8	18		
			Thorne Ln NB-L	250			A	8.7	20	220				A	9.0	14		
			Thorne Ln NB-T	220			-	4.6	A	0.0		150			A	0.0		
			Thorne Ln NB-R															
			Thorne Ln SB-L															
Thorne Ln SB-T	220			-	0.0			300										
Thorne Ln SB-R								5										
22	I-5 NB Ramps / Gravelly Lake Drive	Signal	Overall	1,490	C	33.0				1,820	D	50.4						
			I-5 Off-ramp EB-L	505			E	63.2	#544	720			E	57.2	#654			
			I-5 Off-ramp EB-T	0			E	57.8		5			E	56.7	#654			
			I-5 Off-ramp EB-R	110			D	52.2	#395	60			E	56.1	#638			
			Gravelly Lk Dr NB-L	0						0								
			Gravelly Lk Dr NB-T	140			E	58.8	E	58.8	120	350		F	103.8	F	108.3	#344
			Gravelly Lk Dr NB-R	45					E	58.8	120	90			F	108.3	#344	
			Gravelly Lk Dr SB-L	685			A	4.1	m29	565				A	2.9	m2		
			Gravelly Lk Dr SB-T	5			A	4.0	A	0.0	m0	30		A	2.7	A	0.1	m0
Gravelly Lk Dr SB-R	0							0										

Intersection Analysis Summary - 2040 No Build

No.	Intersection	Control Type	Approach Road	Movement	AM PEAK HOUR					PM PEAK HOUR						
					Post-Process Volume (vph)	LOS	Delay (sec)	LOS	Delay (sec)	95th Queue (ft)	Post-Process Volume (vph)	LOS	Delay (sec)	LOS	Delay (sec)	95th Queue (ft)
23	I-5 SB Ramps / Gravelly Lake Drive	Signal	Overall	2,345	D	43.3				2,520	D	41.5				
			I-5 Off-ramp WB-L	5	E	57.0	E	55.3	17	5	E	58.1	E	56.5	17	
			I-5 Off-ramp WB-T	0					0							
			I-5 Off-ramp WB-R	305			E	57.1	93	295			E	58.1	90	
			Gravelly Lk Dr NB-L	70	A	4.7	A	4.7	36	120	A	9.0				
			Gravelly Lk Dr NB-T	575			A	4.7	36	950			A	9.0	m87	
			Gravelly Lk Dr NB-R	0						0						
			Gravelly Lk Dr SB-L	0						0						
			Gravelly Lk Dr SB-T	685	E	58.1	E	72.9	#958	590	E	67.4	F	88.6	#857	
Gravelly Lk Dr SB-R	705	D	43.7	477			560	D	45.1	339						
25	Gravelly Lake Drive / Pacific Highway	Signal	Overall	2,640	D	36.6				2,720	D	47.6				
			Pacific Hwy WB-L	125	D	43.1	D	44.1	70	210	E	67.7	E	70.5	150	
			Pacific Hwy WB-T	0					0							
			Pacific Hwy WB-R	145			D	42.3	58	185			E	64.4	135	
			Gravelly Lk Dr NB-L	0	E	61.9				0	D	52.4				
			Gravelly Lk Dr NB-T	830			E	63.9	#425	1,125			D	52.4	D	54.6
			Gravelly Lk Dr NB-R	50						120			C	31.3	86	
			Gravelly Lk Dr SB-L	225	C	20.4	B	14.1	138	140	C	34.9	C	27.0	158	
			Gravelly Lk Dr SB-T	1,265			C	21.5	448	940			D	36.0	541	
Gravelly Lk Dr SB-R	0															

Note: For Two-way Stop Control IntersectionS - Overall LOS and delay is based on worse approach/movement
 Signalized and Non-signalized intersections analyzed with Synchro software
 Roundabout intersection analyzed with Sidra software

Appendix D
Summary of I-5 Mainline and Ramp Volumes

This Page Intentionally Left Blank

I-5 Mainline and Ramp Volumes

2013 AM PEAK HOUR - P0 - EXISTING CONDITIONS -- VOLUMES -- MESO - ALL MODE - Post Processed

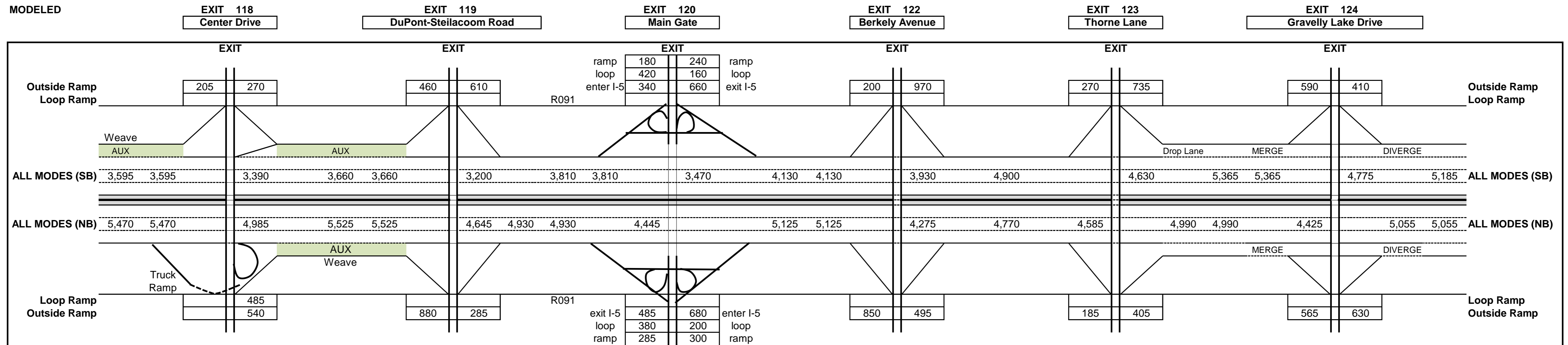

2013 PM PEAK HOUR - P0 - EXISTING CONDITIONS -- VOLUMES -- MESO - ALL MODE - Post Processed

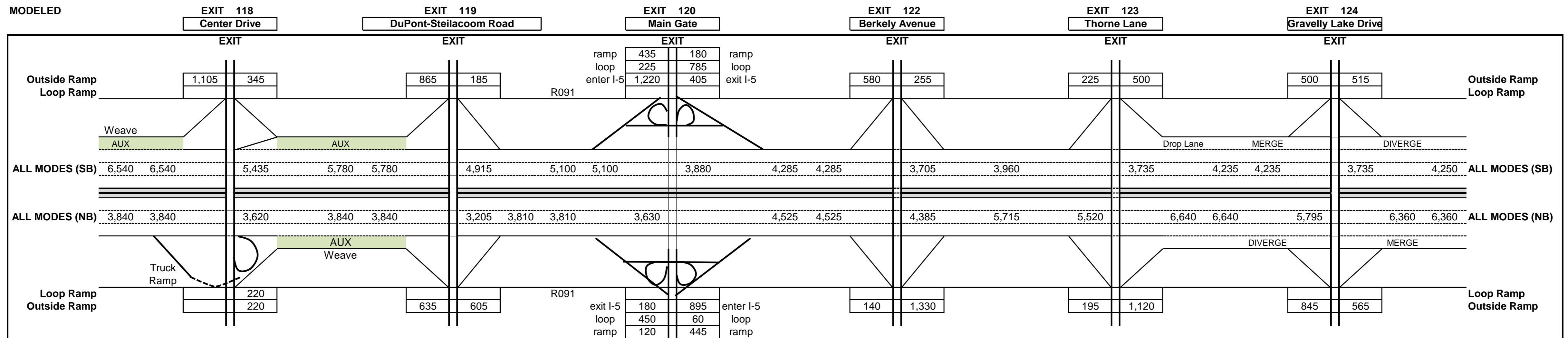

2013 ADT - P0 - EXISTING CONDITIONS -- VOLUMES - ALL MODES

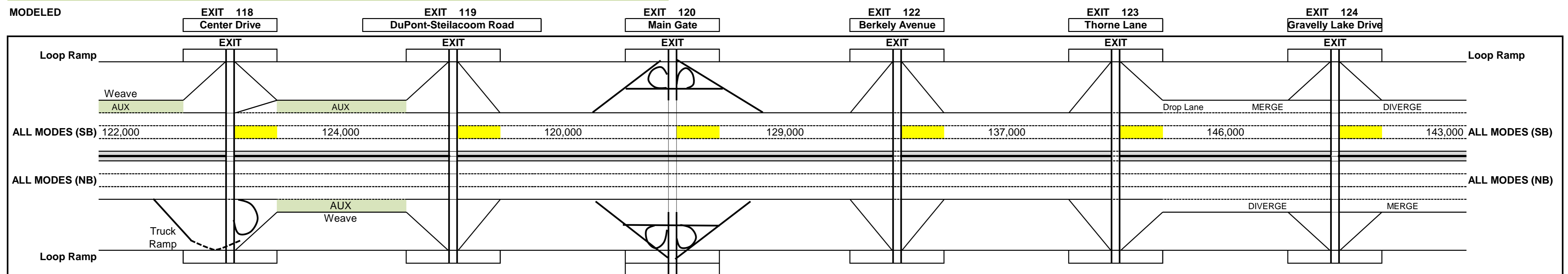

I-5 Mainline and Ramp Volumes

2020 AM PEAK HOUR - P1 - BASE CONDITIONS WITH TIP IMPROVEMENTS -- VOLUMES -- MESO - ALL MODE - Post Processed

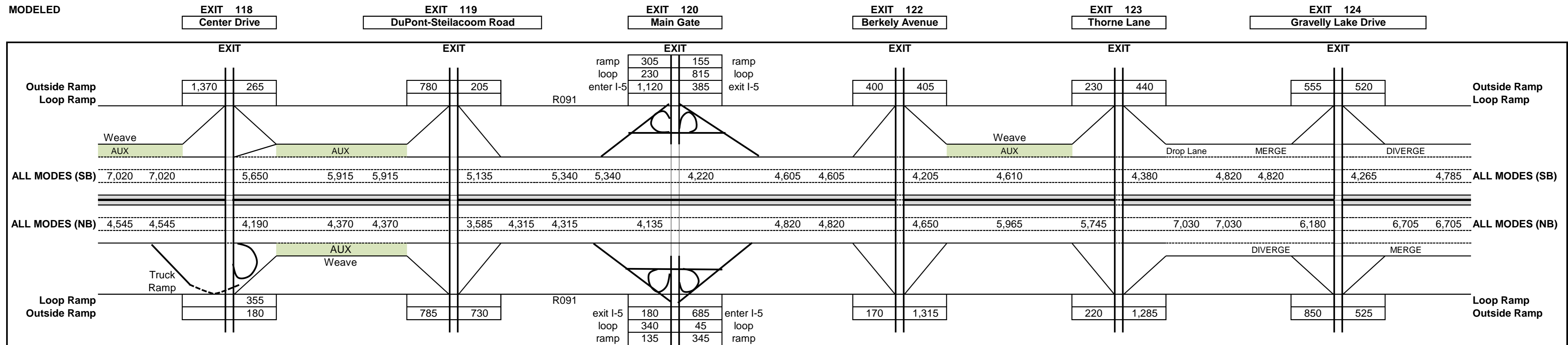

2020 PM PEAK HOUR - P1 - BASE CONDITIONS WITH TIP IMPROVEMENTS-- VOLUMES -- MESO - ALL MODE - Post Processed

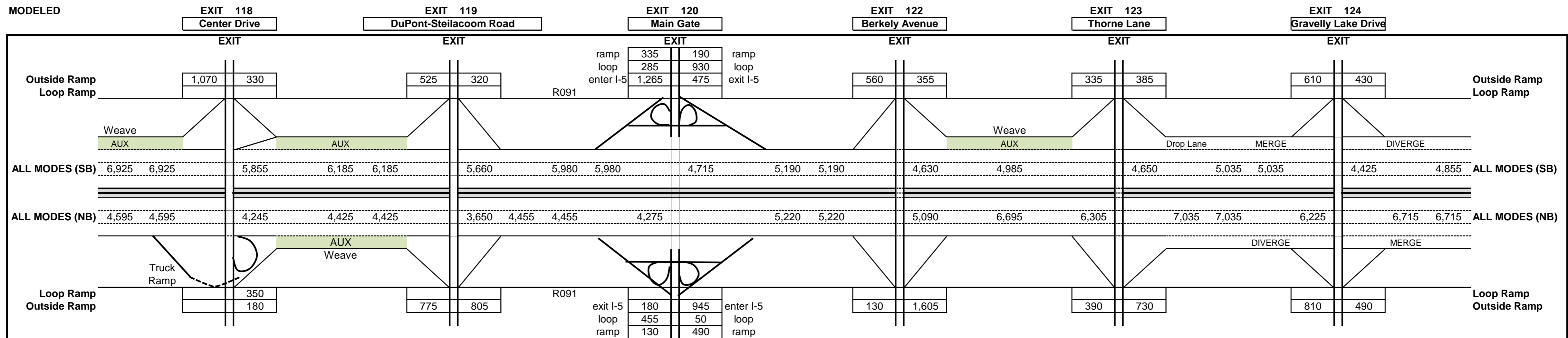

2020 ADT - P0 - EXISTING CONDITIONS -- VOLUMES - ALL MODES

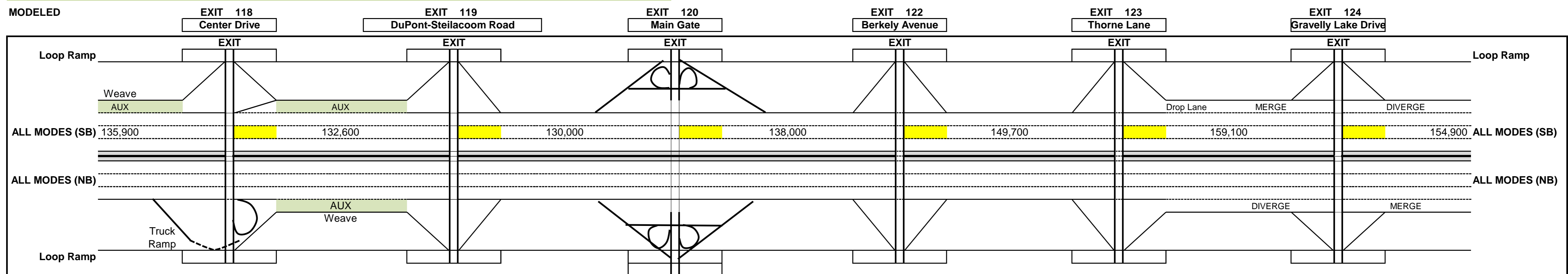

I-5 Mainline and Ramp Volumes

2020 AM PEAK HOUR - REVISED BUILD ALTERNATIVE IMPROVEMENTS -- VOLUMES -- MESO - ALL MODE - Post Processed

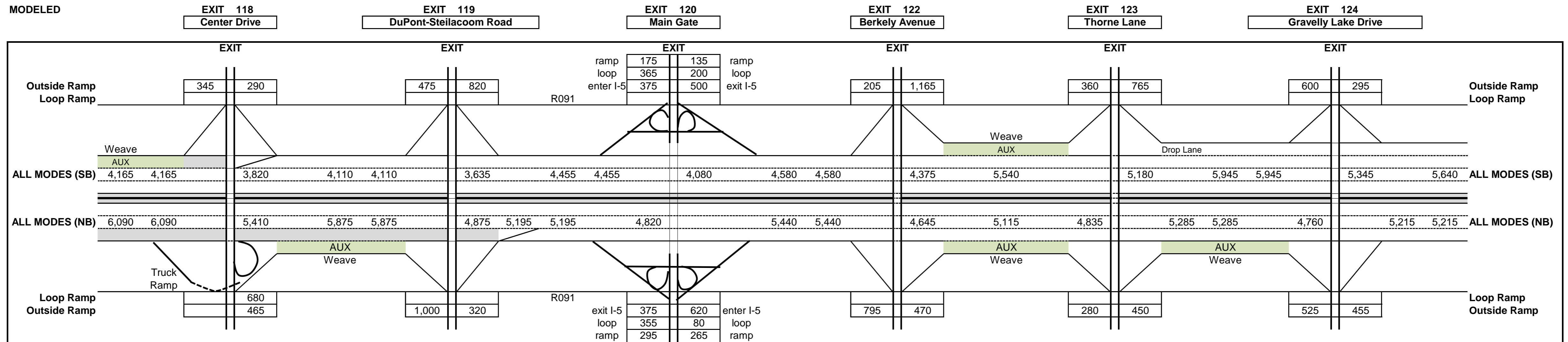

2020 PM PEAK HOUR - REVISED BUILD ALTERNATIVE IMPROVEMENTS -- VOLUMES -- MESO - ALL MODE - Post Processed

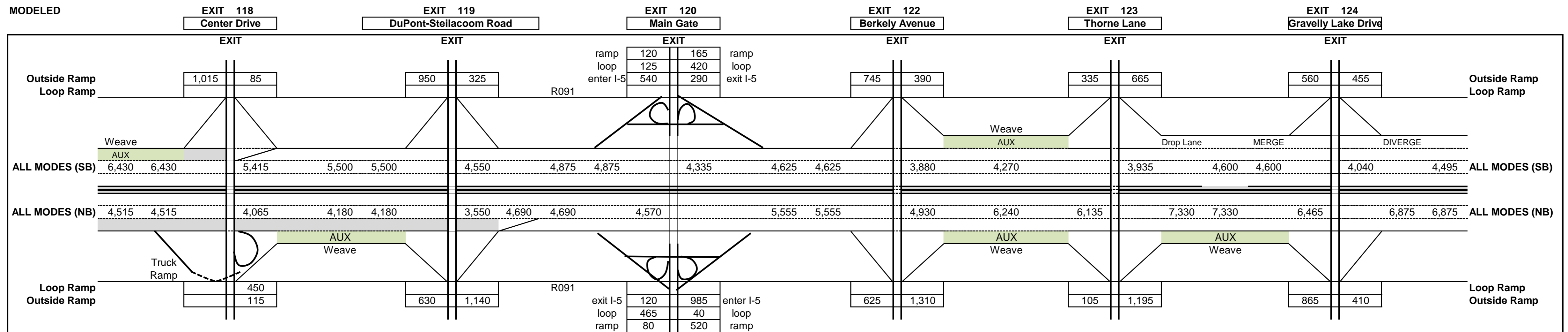

2020 ADT - REVISED BUILD ALTERNATIVE IMPROVEMENTS -- VOLUMES -- ALL MODE

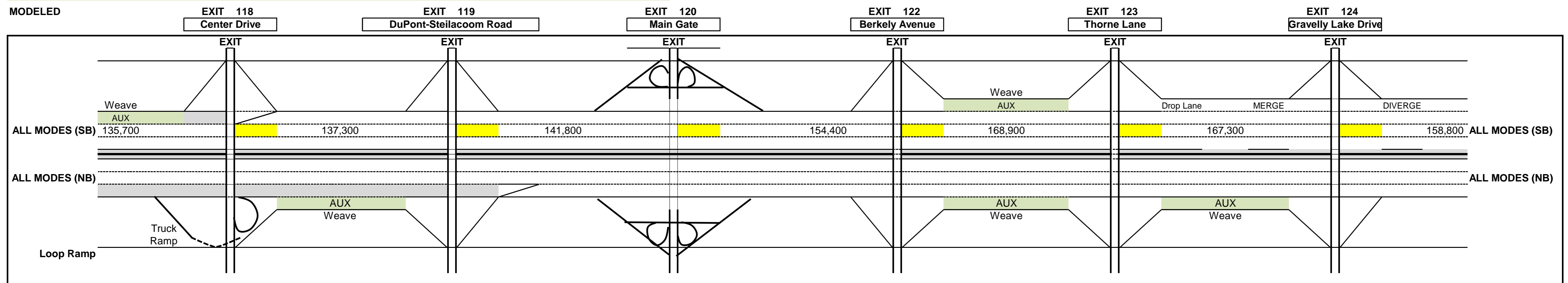

I-5 Mainline and Ramp Volumes

2040 AM PEAK HOUR - REVISED BUILD ALTERNATIVE IMPROVEMENTS -- VOLUMES -- MESO - ALL MODE - Post Processed

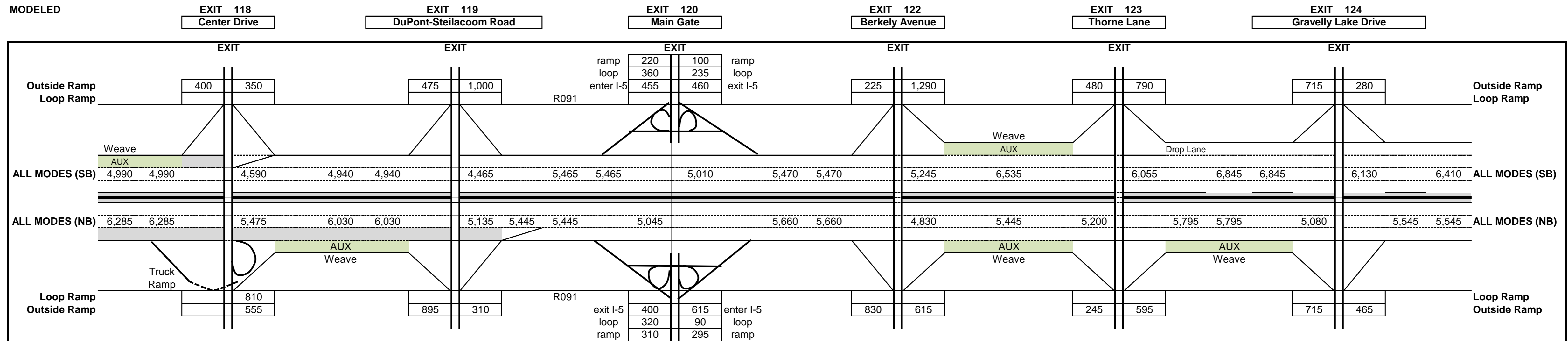

2040 PM PEAK HOUR - REVISED BUILD ALTERNATIVE IMPROVEMENTS -- VOLUMES -- MESO - ALL MODE - Post Processed

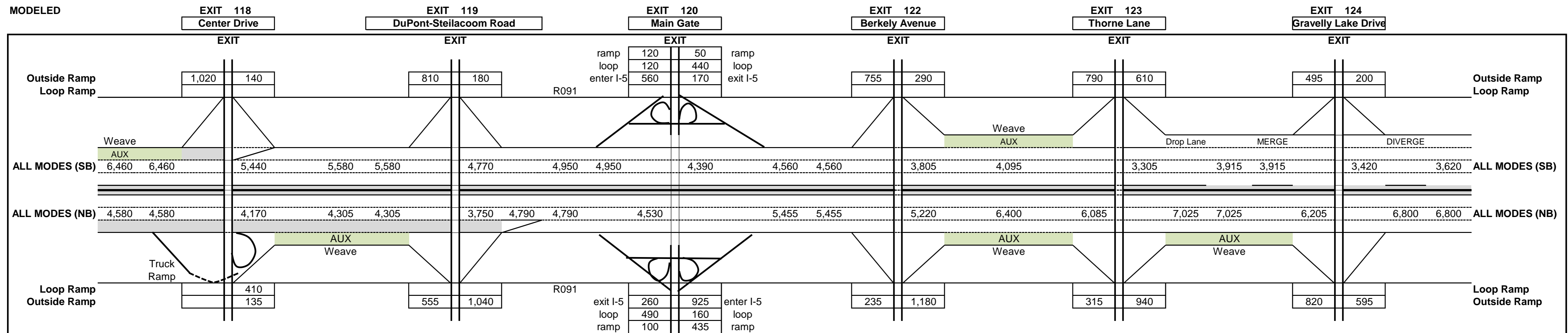

2040 ADT - REVISED BUILD ALTERNATIVE IMPROVEMENTS -- VOLUMES -- ALL MODE

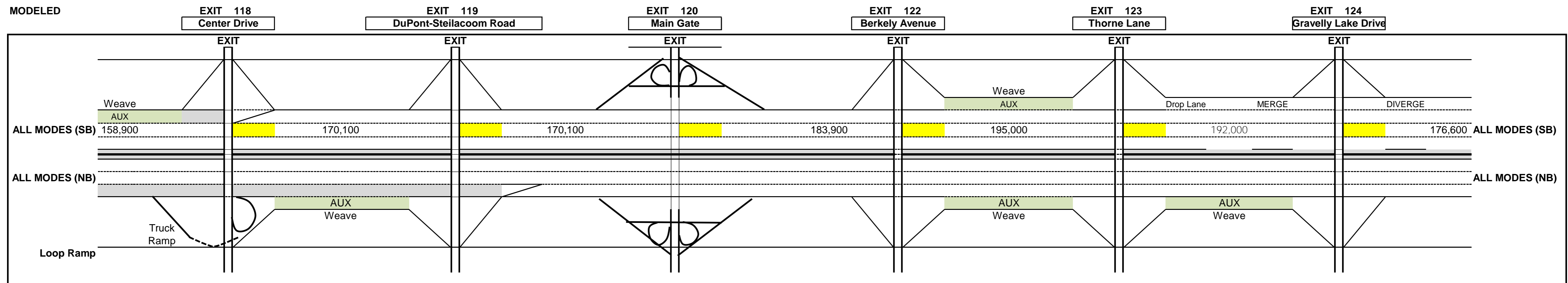

Appendix E
Description of Alternative Packages

This Page Intentionally Left Blank

Description of the Phase 2 Alternative Packages

The alternative packages evaluated as part of the Phase 2 study effort are described below.

P1: No Action Alternative – 2020 and 2040:

The No Action Alternative in 2020 and 2040 is similar to the 2013 existing conditions with the addition of TIGER III Grant projects and the Madigan Access Improvements, as well as projects affecting the area from TIP and STIP programs. In addition, there are other off-I-5 improvements including various JBLM gate changes. Both the opening of the new Integrity Gate and modifications to the Mounts Road Gate may affect traffic volumes at the I-5 interchanges.

Transit service enhancements identified in PSRC's *Transportation 2040* regional plan are also assumed to be in place in this alternative. These enhancements focus primarily on the long-term plans of Sound Transit and include the extension of Sounder Commuter Rail to DuPont. For 2020, existing transit service is assumed.

P2: Enhanced Transit Alternative – 2020 and 2040:

This package contains all elements of the P1 – No Action Alternative. It would also add enhanced transit service including the following new bus routes with 15-minute headways during peak commute periods:

- Lacey to DuPont P&R to Main Gate to Lakewood
- Lacey to Yelm to East Gate to Spanaway or Puyallup
- Lacey to SR 512 park-and-ride lot to Downtown Tacoma
- Spanaway to Lakewood to Lacey
- Lacey to Main Gate to Lakewood

These new routes represent what would essentially be a doubling of existing service along the I-5 corridor. Alternative P2 also assumes an expanded shuttle bus system on JBLM that matches the off-Base transit schedule, thus facilitating a smooth and connected trip to and from the base.

P3: Alternative with Local Road Improvements with Enhanced Transit Service – 2020 and 2040: This package contains all elements of the P2 – Enhanced Transit Alternative and would also include the following local road improvements, as illustrated in Figure 1:

- B-3: Gravelly Lake Connector – Add a new 2-lane urban road west of and parallel to I-5 between Thorne Lane and Gravelly Lake Drive.
- B-13: SR 507 – Widen 507 to four lanes from McKenna to East Gate Road.
- B-17: New High Speed Road – Construct a new highway/high speed arterial road from the Joint Base Connector Road to 176th Street SE.
- C-7: South A Road Extension – Extend South A Road from Jackson Road to Logistics Gate.
- C-8: Joint Base Connector Phase 2 – Add a new 4-lane higher speed connection between Lewis Main and McChord Field.

- C-9: Fairway Road Extension – Improve and extend Fairway Road as 2-lane road from the new Joint Base Connector to Bridgeport Way.
- C-15b: New arterial – Add a two-lane urban road close to the I-5 corridor, from Mounts Road to Jackson Avenue.
- C-21: New JBLM Collector Street, DuPont Gate to East Gate – Construct or improve a new two-lane road, following the rail alignment and combat vehicle trail.
- C-30: On-Base Signalization Improvements – Synchronize existing traffic signal operations in the Pendleton Avenue/Jackson Avenue corridor.

P4: I-5 Express Lanes Alternative – 2020 and 2040:

Alternative P4 would add two I-5 express lanes in each direction. The express lanes would extend from north of the Center Drive Interchange to north of the Gravelly Lake Drive Interchange. These express lanes would be ‘managed lanes’ and can evolve over time to best address demand, technology, and future conditions. Some possible options for the managed lanes could include: congestion pricing, High Occupancy Vehicle (HOV) lane(s), High Occupancy and Toll (HOT) lane(s), “truck only” lane(s), and/or “smart car only” lane(s).

For analysis purposes, it was assumed that the express lanes would include an HOV lane and a GP lane in each direction. For the 2020 analysis, one of the existing GP lanes north of the Gravelly Lake Drive Interchange was assumed to be converted to an HOV lane. In the 2040 configuration, an HOV lane would be added to the existing four GP lanes north of Thorne Lane and would be added to the existing three lanes at the south end of the project into Thurston County.

P4a: I-5 Express Lanes Alternative with Local Road Improvements – 2020 and 2040:

This alternative package would include all the improvements in the P4 – Express Lane Alternative and would add the three local road improvements listed below:

- B-3: Gravelly Lake Connector – A new 2-lane urban road west of and parallel to I-5 between Thorne Lane and Gravelly Lake Drive
- C-8: Joint Base Connector – A new 4-lane higher speed connection between Fort Lewis and McChord Field.
- C-9: Fairway Road Extension – Improve and extend Fairway Road as 2-lane road from the new Joint Base Connector to Bridgeport Way.

These local improvements would provide alternative on-Base and off-Base local routes for travel between downtown Lakewood and the Tillicum neighborhood without using I-5, for internal travel between the Lewis Main and McChord Field areas of JBLM, and for travel from Lewis Main to Lakewood without using I-5.

P5: I-5 HOV and CD/Auxiliary Lanes Alternative – 2020 and 2040:

Alternative P5 would add an HOV lane in each direction and two sets of CD Lanes connected by auxiliary lanes. One set of CD lanes would link the ramps at the Mounts Road, Center Drive, and Steilacoom-

DuPont Road Interchanges. The other set would use an auxiliary lane to link ramps at the Berkeley Street and Thorne Lane Interchanges to Gravelly Lake Drive. These two sets of CD lanes would be connected with auxiliary lanes between the Steilacoom-DuPont CD lanes and the Berkeley CD lanes. For the 2020 analysis one of the existing GP lanes north of the Thorne Lane Interchange is assumed to be converted to an HOV lane. In the 2040 configuration, an HOV lane would be added to the existing four GP lanes at the north end and to the existing three lanes at the south end of the project.

P5a: I-5 HOV and CD/Auxiliary Lanes Alternative with Local Road Improvements – 2020 and 2040:

This alternative package would include all the improvements in the P5 – HOV and CD Lanes Alternative and would add the three local road improvement projects associated with Alternative Package P4a.

P6: I-5 HOV and GP Lanes Alternative – 2020 and 2040:

Alternative P6 would add an HOV lane and a GP lane in each direction along I-5. A fourth GP lane would be added from Mounts Road to Thorne Lane in each direction. For the 2020 analysis, the HOV lanes would end south of the Steilacoom-DuPont Road Interchange and one of the existing GP lanes north of the Thorne Lane Interchange is assumed to be converted to an HOV lane. In the 2040 configuration, an HOV lane would be added to the existing four GP lanes at the north end of the project, and to the existing three lanes at the south end. For modelling purposes in 2040, the HOV lane is assumed to extend from Thurston County to Tacoma.

P6a: I-5 HOV and GP Lanes Alternative with Local Road Improvements – 2020 and 2040:

This alternative package would include all the improvements in the P6 – HOV and GP Lanes Alternative and would add the three local road improvements associated with Alternative Package P4a.

P7: I-5 HOV Lane Alternative – 2020 and 2040:

Alternative P7 would add an HOV lane in each direction along I-5. For 2020, the extra lanes would begin and end at the Center Drive Interchange and the inside northbound lane would become an HOV lane at the Steilacoom-DuPont Road Interchange. For the 2020 analysis one of the existing GP lanes north of the Thorne Lane Interchange is assumed to be converted to an HOV lane. In the 2040 configuration, an HOV lane would be added to the existing four GP lanes at the north end and to the existing three lanes at the south end of the project. For 2040 modelling purposes, the I-5 configuration assumes the HOV lanes extend from Thurston County to Tacoma. An existing GP lane in each direction north of the Thorne Lane Interchange would be converted into an HOV lane.

P7a: I-5 HOV Lane Alternative with Local Road Improvements and Transit Enhancements – 2020 and 2040:

This alternative package would include all the improvements in the P7 – HOV Lanes Alternative and would add the enhanced transit improvements included in Alternative P2. It would also add the three local road improvement projects associated with Alternative Package P4a.

P7b: I-5 HOV Lane Alternative with Local Road Improvements – 2020 and 2040:

This alternative package is the same as Alternative P7a except the enhanced transit improvements would not be included.

Figure 1: Selected Local Road Improvements in Alternative Package P3



Appendix F

Build Alternative
Intersection Analysis Summary

This Page Intentionally Left Blank

Intersection Analysis Summary - 2020 Revised Build

No.	Intersection	Control Type	Approach Road	Movement	AM PEAK HOUR					PM PEAK HOUR						
					Post-Process Volume (vph)	LOS	Delay (sec)	LOS	Delay (sec)	95th Queue (ft)	Post-Process Volume (vph)	LOS	Delay (sec)	LOS	Delay (sec)	95th Queue (ft)
						Approach	Movement			Approach		Movement				
3	I-5 NB Ramps / Center Drive	Stop Control on EB Center Drive from Base (I-5 Off Loop Ramp as thru trips)	Overall	510	B	12.3				350	B	10.9				
			Center Drive EB-L													
			Center Drive EB-T													
			Center Drive EB-R													
			I-5 Off Loop Ramp NB-L	20			B	12.3	6	235	B	10.9	B	10.9	32	
			I-5 Off Loop Ramp NB-T		B	12.3										
			I-5 Off Loop Ramp NB-R	15												
			Center Drive SB-L		A	0.0				115		0.0				
Center Drive SB-T	475															
Center Drive SB-R																
4	I-5 SB Ramps / Center Drive	Two-way Stop Control on Ramps	Overall	1,780	C	15.3				1,900	B	11.4				
			I-5 Off-ramp WB-L	0												
			I-5 Off-ramp WB-T	0	C	15.3					B	11.4				
			I-5 Off-ramp WB-R	295			C	15.3	62	85			B	11.4	12	
			Center Drive NB-L	0			A	0.0		0			A	0.0		
			Center Drive NB-T	675	A	0.0				685		0.0				
			Center Drive NB-R	0												
			Center Drive SB-L	0												
Center Drive SB-T	475	A	0.0				115		0.0	A	0.0					
Center Drive SB-R	335						1,015			A	0.0					
5	Center Drive / Wilmington Drive	Signal	Wilmington Drive Overall	1,920	B	13.0				2,110	B	18.6				
			Wilmington Drive EB-L	5			B	15.2	8	10			B	11.8	10	
			Wilmington Drive EB-T	20	B	15.6				20	B	12.1	B	12.1	27	
			Wilmington Drive EB-R	70			B	15.6	31	65			B	12.1	27	
			Wilmington Drive WB-L	135			B	19.9	76	355			C	29.2	#224	
			Wilmington Drive WB-T	15	B	18.7				25	C	25.0	B	12.2	32	
			Wilmington Drive WB-R	35			B	15.4	23	90			B	12.2	32	
			Center Drive NB-L	105			C	27.5	70	55			E	55.1	#52	
			Center Drive NB-T	585	B	10.3				525	B	17.2	B	14.3	138	
			Center Drive NB-R	280			A	8.2	151	190			B	14.3	138	
			Center Drive SB-L	55			F	82.1	45	55			E	55.1	#52	
			Center Drive SB-T	605	B	15.0				710	B	16.9	B	14.0	153	
Center Drive SB-R	10			A	9.0	130	10			B	14.0	153				
6	I-5 NB Ramps / Steilacoom - DuPont Road	Signal	Overall	2,125	C	22.3				2,580	D	43.8				
			I-5 Off-ramp EB-L	380			D	47.6	#358	395			F	94.2	#541	
			I-5 Off-ramp EB-T	5	B	18.4				10	E	60.6	F	94.2	#541	
			I-5 Off-ramp EB-R	640			A	0.8	0	225			A	0.2	0	
			Clark Road NB-L	0												
			Clark Road NB-T	360	D	44.7				690	E	58.3	E	74.1	#812	
			Clark Road NB-R	80			C	26.7	34	350			C	27.2	131	
			Steilacoom-DuPont SB-L	255			A	8.6	m166	780			B	16.0	m28	
Steilacoom-DuPont SB-T	405	B	13.4				130	B	15.6	B	15.2	m27				
Steilacoom-DuPont SB-R	0															
7	I-5 SB Ramps / Steilacoom - DuPont Road	Signal	Overall	2,330	D	37.2				2,765	D	41.2				
			I-5 Off-ramp WB-L	185			C	24.2	141	20			D	52.3	39	
			I-5 Off-ramp WB-T	0	D	54.7					D	52.9	D	52.3	39	
			I-5 Off-ramp WB-R	660			E	63.3	#485	305			D	53.0	90	
			Steilacoom-DuPont NB-L	190			D	43.3	#574	485			C	33.0	m#958	
			Steilacoom-DuPont NB-T	550	D	43.3				600	C	33.0	C	33.0	m#958	
			Steilacoom-DuPont NB-R	0												
			Steilacoom-DuPont SB-L	0												
Steilacoom-DuPont SB-T	475	B	11.4				890	D	45.0	E	68.2	#516				
Steilacoom-DuPont SB-R	270						465			A	0.5	0				

Intersection Analysis Summary - 2020 Revised Build

No.	Intersection	Control Type	Approach Road	Movement	AM PEAK HOUR					PM PEAK HOUR								
					Post-Process Volume (vph)	LOS	Delay (sec)	LOS	Delay (sec)	95th Queue (ft)	Post-Process Volume (vph)	LOS	Delay (sec)	LOS	Delay (sec)	95th Queue (ft)		
																	Approach	Movement
8	Steilacoom - DuPont Road / Barksdale Avenue / Wilmington Drive	Signal	Overall		2,555	D	46.9				2,580	D	37.4					
			Wilmington Drive	EB-L	20				D	43.4	33	40			D	55.0	68	
			Wilmington Drive	EB-T	70	D	38.7			D	37.6	88	80	D	53.0	D	52.2	125
			Wilmington Drive	EB-R	20					D	37.6	88	20			D	52.2	125
			Steilacoom-DuPont	WB-L	245					C	30.7	m116	330			E	62.2	m275
			Steilacoom-DuPont	WB-T	75	D	42.7			C	22.7	m31	90	E	59.1	D	36.4	m56
			Steilacoom-DuPont	WB-R	890					D	47.7	m78	485			E	61.1	m64
			Steilacoom-DuPont	NB-L	10					D	37.5	20	45	B	13.7	D	48.5	70
			Steilacoom-DuPont	NB-T	75	C	20.2			D	41.0	82	135			E	56.5	170
			Steilacoom-DuPont	NB-R	85					A	0.1	0	565			A	0.7	0
			Barksdale Avenue	SB-L	985					E	57.0	#656	710			C	32.4	430
			Barksdale Avenue	SB-T	65	E	56.7			E	56.4	#666	50	C	32.2	C	32.1	421
Barksdale Avenue	SB-R	15					E	56.4	#666	30			C	32.1	421			
11	I-5 NB Ramps / 41st Division Drive (Main Gate)	Cloverleaf Merge / Diverge	Overall															
			I-5 Off Loop Ramp	EB-R														
			I-5 Off-Ramp	WB-R														
			41st Division Drive	NB-T														
			41st Division Drive	NB-R														
				SB-L														
			41st Division Drive	SB-T														
41st Division Drive	SB-R																	
12	I-5 SB Ramps / 41st Division Drive (Main Gate)	Cloverleaf Merge / Diverge	Overall															
			I-5 Off Loop Ramp	EB-R														
			I-5 Off-ramp	WB-R														
			41st Division Drive	NB-T														
			41st Division Drive	NB-R														
			41st Division Drive	SB-T														
			41st Division Drive	SB-R														
13	I-5 NB Ramps / Berkeley Avenue	RAB	Overall		2,665	A	4.4				3,275	A	5.2					
			I-5 Off-ramp	EB-L	170				A	7.5	24	225			A	6.4	26	
			I-5 Off-ramp	EB-T		A	1.7					0	A	2.3	A	6.4	26	
			I-5 Off-ramp	EB-R	630				A	0.1		400			A	0.0		
			Berkeley Ave	NB-L														
			Berkeley Ave	NB-T	240	A	2.7			A	5.4	27	880	A	6.2	B	10.8	146
			Berkeley Ave	NB-R	445					A	1.3	19	1,305			A	3.1	146
			Berkeley Ave	SB-L	60					A	7.4		5			A	4.3	
			Berkeley Ave	SB-T	1,120	A	7.0			A	7.2		460	A	4.2	A	4.2	
Berkeley Ave	SB-R																	
14	I-5 SB Ramps / Berkeley Avenue	RAB	Overall		1,830	B	13.2				1,775	A	9.1					
			I-5 Off-ramp	WB-L	1,020				B	15.3	144	380			A	8.7	30	
			I-5 Off-ramp	WB-T		B	15.2					5	A	8.7	A	8.1	30	
			I-5 Off-ramp	WB-R	185				B	14.9	144	5			A	8.1	30	
			Berkeley Ave	NB-L	140				A	4.2		545			A	7.1		
			Berkeley Ave	NB-T	270	A	4.2			A	4.3		560	A	6.8	A	6.6	
			Berkeley Ave	NB-R														
			Berkeley Ave	SB-L														
			Berkeley Ave	SB-T	160	B	19.3			B	19.3	70	85	B	18.6	B	18.6	95
Berkeley Ave	SB-R	55					B	19.3	70	195			B	18.6	95			
15	Berkeley Avenue / Union Avenue	two-way Stop Control	Overall		385	C	15.2				305	A	9.0					
			Militia Dr	EB-L	5				C	15.2	3							
			Militia Dr	EB-T	5	C	15.2			C	15.2	3						
			Militia Dr	EB-R	0													
			Union Ave	WB-L	0													
			Union Ave	WB-T	5	A	9.1			A	9.1		5	A	9.0	A	9.0	
			Union Ave	WB-R	150					A	9.1	15	115			A	9.0	11
			Berkeley Ave	SB-L	205					A	7.2	14	175			A	7.2	12
			Berkeley Ave	SB-T		A	7.2							A	7.2			
Berkeley Ave	SB-R	15					A	7.2	14	10			A	7.2	12			

Intersection Analysis Summary - 2020 Revised Build

No.	Intersection	Control Type	Approach Road	Movement	AM PEAK HOUR					PM PEAK HOUR							
					Post-Process Volume (vph)	LOS	Delay (sec)	LOS	Delay (sec)	95th Queue (ft)	Post-Process Volume (vph)	LOS	Delay (sec)	LOS	Delay (sec)	95th Queue (ft)	
																	Approach
16	Berkeley Avenue/ Jackson Extension	New All-way Stop Control	Overall	760	B	13.9				920	C	23.8					
			RAMP	EB-L	280	C	16.4	C	16.4	125	415	D	31.7	D	31.7	250	
			RAMP	EB-T													
			RAMP	EB-R	175			C	16.4	125	150			D	31.7	250	
			Berkeley Ave	NB-L	150	B	10.4	B	11.0	28	140	B	11.3	B	11.9	30	
			Berkeley Ave	NB-T	45			A	8.3	7	40			A	8.9	5	
			Berkeley Ave	NB-R													
			Berkeley Ave	SB-L		A	9.5					B	11.1				
Berkeley Ave	SB-T	45	A	9.5	10			35	B	11.1	27						
Berkeley Ave	SB-R	65	A	9.5	10			140	B	11.1	27						
17	Berkeley Avenue/ Washington Avenue	Stop Control on Washington (Right in/out)	Overall	420	A	9.3				370	A	9.2					
			Washington Ave	EB-L													
			Washington Ave	EB-T													
			Washington Ave	EB-R													
			Washington Ave	WB-L	0	A	9.3	A	9.3	4		A	9.2				
			Washington Ave	WB-T	0			A	9.3	4							
			Washington Ave	WB-R	45			A	9.3	4	70			A	9.2	7	
			Berkeley Ave	NB-L									0.0				
			Berkeley Ave	NB-T	150						110						
			Berkeley Ave	NB-R	5						5						
Berkeley Ave	SB-L									0.0							
Berkeley Ave	SB-T	220						0			185						
Berkeley Ave	SB-R							0									
18	I-5 NB Ramps / Thorne Lane	RAB	Overall	1,565	A	5.5				2,225	A	7.1					
			I-5 Off-ramp	EB-L	15	A	9.8	A	9.8	35	10	B	10.4	B	10.4	23	
			I-5 Off-ramp	EB-T							5			B	10.4	23	
			I-5 Off-ramp	EB-R	185			A	9.8	35	90			B	10.4	23	
			Thorne Ln	NB-L		A	4.9					A	5.5	B	12.5	124	
			Thorne Ln	NB-T	435			A	7.7	74	375			A	5.5	0	
			Thorne Ln	NB-R	255					485				A	0.1	0	
			Thorne Ln	SB-L	245	A	4.9	A	5.1		705	A	7.9	A	8.2	0	
Thorne Ln	SB-T	430	A	4.9				555	A	7.5	0						
Thorne Ln	SB-R																
19	I-5 SB Ramps / Thorne Lane	RAB	Overall	1,765	A	8.8				2,020	B	14.6					
			I-5 Off-ramp	WB-L	315	A	9.5	A	9.2	84	305	A	8.0	A	8.6	63	
			I-5 Off-ramp	WB-T	5			A	9.2	84	10			A	8.6	63	
			I-5 Off-ramp	WB-R	405			A	10.0	74	350			A	7.5	62	
			Thorne Ln	NB-L	405	A	7.0	A	7.0		310	A	6.3	A	6.3		
			Thorne Ln	NB-T	325			A	7.0		75			A	6.3		
			Thorne Ln	NB-R													
			Thorne Ln	SB-L		A	9.6					C	22.3				
Thorne Ln	SB-T	270	A	9.8	50			955	C	22.3	266						
Thorne Ln	SB-R	40	A	8.8	50			15	C	20.7	266						
20	Thorne Lane / Union Avenue (Union Ave Loop)	Tee with Stop Sign on Union Avenue	Overall	205	A	9.6				300	B	11.2					
			Union Ave	EB-L	20	A	9.6	A	9.6	2	110	B	11.2	B	11.2	18	
			Union Ave	EB-T													
			Union Ave	EB-R	0						0						
			Thorne Ln	NB-L	25	A	7.7	A	7.7	2	65	A	7.6	A	7.6	4	
			Thorne Ln	NB-T	0			A	7.7		10			A	7.6	4	
			Thorne Ln	NB-R													
			Thorne Ln	SB-L													
Thorne Ln	SB-T	0						0									
Thorne Ln	SB-R	160						115									
21	New Thorne Lane - Union Avenue Loop	RAB	Overall	771	A	6.5				1,405	C	21.1					
			Union Loop	WB-L	20	A	4.5	A	4.5	3	115	A	5.2	A	72.3	18	
			Union Loop	WB-T				A	4.5	3							
			Union Loop	WB-R	1					5			A	10.6	18		
			Thorne Ln	NB-L		A	7.0					A	7.0				
			Thorne Ln	NB-T	300			A	7.3	80	315			A	7.0	93	
			Thorne Ln	NB-R	160			A	6.6	80	110			A	7.0	93	
Thorne Ln	SB-L	0						5			C	8.3	599				

Intersection Analysis Summary - 2020 Revised Build

No.	Intersection	Control Type	Approach Road	Movement	AM PEAK HOUR					PM PEAK HOUR								
					Post-Process Volume (vph)	LOS	Delay (sec)	LOS	Delay (sec)	95th Queue (ft)	Post-Process Volume (vph)	LOS	Delay (sec)	LOS	Delay (sec)	95th Queue (ft)		
					Approach		Movement			Approach		Movement						
			Thorne Ln	SB-T	290	A	5.7	A	5.7	48	855	C	30.4	C	8.3	599		
			Thorne Ln	SB-R														
22	I-5 NB Ramps / Gravelly Lake Drive	Signal		Overall	1,230	C	24.0				1,460	C	35.0					
				I-5 Off-ramp	EB-L	380			D	44.9	#361	790			D	51.1	#651	
				I-5 Off-ramp	EB-T	0	D	41.3	D	37.5	214	5	D	50.9	D	50.8	#642	
				I-5 Off-ramp	EB-R	145			D	37.5	214	0			D	50.8	#642	
				Gravelly Lk Dr	NB-L	0												
				Gravelly Lk Dr	NB-T	120	D	43.4	D	43.4	76	160	D	52.4	D	52.4	111	
				Gravelly Lk Dr	NB-R	25			D	43.4	76	10			D	52.4	111	
				Gravelly Lk Dr	SB-L	505			A	2.9	m51	395			A	1.2	m1	
				Gravelly Lk Dr	SB-T	55	A	2.7	A	0.1	m0	100	A	1.1	A	0.6	m0	
				Gravelly Lk Dr	SB-R	0												
23	I-5 SB Ramps / Gravelly Lake Drive	Signal		Overall	2,035	D	38.4				2,430	D	37.9					
				I-5 Off-ramp	WB-L	5			D	42.6	13	15			D	51.7	33	
				I-5 Off-ramp	WB-T	0	D	44.0	D	42.6	13		D	53.8	D	51.7	33	
				I-5 Off-ramp	WB-R	290			D	44.0	76	440			D	53.9	109	
				Gravelly Lk Dr	NB-L	70						15			A	3.1	43	
				Gravelly Lk Dr	NB-T	555	A	9.2	A	9.2	64	935	A	3.1	A	3.1	43	
				Gravelly Lk Dr	NB-R	0												
				Gravelly Lk Dr	SB-L	0												
	Gravelly Lk Dr	SB-T	555	D	53.3	E	60.8	#728	480	E	63.2	E	74.9	#651				
	Gravelly Lk Dr	SB-R	560			D	45.9	232	545			D	52.8	252				
25	Gravelly Lake Drive / Pacific Highway	Signal		Overall	2,345	B	12.6				3,020	B	17.9					
				Pacific Hwy	WB-L	110			D	49.3	69	260			E	60.0	156	
				Pacific Hwy	WB-T	0	D	48.3					E	57.2				
				Pacific Hwy	WB-R	105			D	47.3	53	230			D	54.1	142	
				Gravelly Lk Dr	NB-L	0												
				Gravelly Lk Dr	NB-T	805	A	4.5	A	4.6	138	1,220	B	10.4	B	11.1	185	
				Gravelly Lk Dr	NB-R	40			A	1.4	m2	155			A	5.0	m8	
				Gravelly Lk Dr	SB-L	250			D	51.2	248	315			C	28.1	230	
	Gravelly Lk Dr	SB-T	1,035	B	12.0	A	2.5	106	840	B	10.3	A	3.6	133				
	Gravelly Lk Dr	SB-R																

Note: For Two-way Stop Control Intersections - Overall LOS and delay is based on worse approach/movement
 Signalized and Non-signalized intersections analyzed with Synchro software
 Roundabout intersection analyzed with Sidra software

Intersection Analysis Summary - 2040 Revised Build

No.	Intersection	Control Type	Movement	AM PEAK HOUR						PM PEAK HOUR							
				Post-Process Volume (vph)	LOS	Delay (sec)	LOS	Delay (sec)	95th Queue (ft)	Post-Process Volume (vph)	LOS	Delay (sec)	LOS	Delay (sec)	95th Queue (ft)		
																Approach	Movement
3	I-5 NB Ramps / Center Drive	Stop Control on EB Center Drive from Base (I-5 Off Loop Ramp as thru trips)	Overall	575	B	13.3				580	C	15.0					
			Center Drive EB-L							445	C	15.0	C	15.0	97		
			Center Drive EB-T	20	B	13.3	B	13.3	4								
			Center Drive EB-R														
			I-5 Off Loop Ramp NB-L														
			I-5 Off Loop Ramp NB-T														
			I-5 Off Loop Ramp NB-R														
			Center Drive SB-L														
Center Drive SB-T	555		0.0	A	0.0			135		0.0							
Center Drive SB-R																	
4	I-5 SB Ramps / Center Drive	Two-way Stop Control on Ramps	Overall	2,135	C	21.0				2,340	F	63.1					
			I-5 Off-ramp WB-L	0						140	F	36.3	F	166.2	201		
			I-5 Off-ramp WB-T	0	C	21.0				0							
			I-5 Off-ramp WB-R	350			C	21.0	108		310			C	16.8	74	
			Center Drive NB-L	0			A	0.0			120	A	2.4	A	5.6	17	
			Center Drive NB-T	830		0.0	A	0.0			735					A	0.0
			Center Drive NB-R	0							0						
			Center Drive SB-L	0							0						
Center Drive SB-T	555		0.0	A	0.0			135	A	0.0	A	0.0					
Center Drive SB-R	400			A	0.0			900					A	0.0			
5	Center Drive / Wilmington Drive	Signal	Wilmington Drive Overall	2,295	B	13.7				2,135	B	18.7					
			Wilmington Drive EB-L	5			B	17.7	8	10	B	12.3	B	12.1	10		
			Wilmington Drive EB-T	20	B	18.1	B	18.1	35	20					B	12.4	30
			Wilmington Drive EB-R	75			B	18.1	35	85			B	12.4	30		
			Wilmington Drive WB-L	165			C	29.5	102	325	C	26.5	C	31.7	#203		
			Wilmington Drive WB-T	15	C	26.8	B	17.9	26	30					B	12.5	34
			Wilmington Drive WB-R	35			B	17.9	26	90			B	12.5	34		
			Center Drive NB-L	120			C	24.7	85	60	B	16.4	E	57.2	#52		
			Center Drive NB-T	710	B	11.0	A	9.4	201	520					B	13.4	123
			Center Drive NB-R	350			A	9.4	201	295			B	13.4	123		
			Center Drive SB-L	70			D	51.4	59	65	B	17.6	E	70.3	#57		
			Center Drive SB-T	715	B	13.8	B	10.2	160	625					B	12.3	118
Center Drive SB-R	15			B	10.2	160	10			B	12.3	118					
6	I-5 NB Ramps / Steilacoom - DuPont Road	Signal	Overall	2,010	C	28.6				2,360	D	49.3					
			I-5 Off-ramp EB-L	395			E	56.6	426	425	E	66.7	F	85.1	#563		
			I-5 Off-ramp EB-T	5	C	25.5	E	56.6	426	10					F	85.1	#563
			I-5 Off-ramp EB-R	495			A	0.5	0	120			A	0.1	0		
			Clark Road NB-L	0						0	E	68.0					
			Clark Road NB-T	400	E	55.5	E	58.0	433	620					F	82.0	#753
			Clark Road NB-R	70			D	37.0	35	225			C	29.2	90		
			Steilacoom-DuPont SB-L	235			A	9.0	m#210	805	C	22.8	C	22.7	m#49		
Steilacoom-DuPont SB-T	410	B	13.4	B	15.5	m#655	155			C			23.0	m#51			
Steilacoom-DuPont SB-R	0						0										
7	I-5 SB Ramps / Steilacoom - DuPont Road	Signal	Overall	2,570	F	82.2				2,535	C	30.9					
			I-5 Off-ramp WB-L	160			C	28.6	155	35	E	55.3	E	58.2	64		
			I-5 Off-ramp WB-T	0	F	108.5	C	28.6	155	0					E	58.2	64
			I-5 Off-ramp WB-R	840			F	123.7	#965	145			D	54.6	#7		
			Steilacoom-DuPont NB-L	185			F	98.5	#1039	425	C	23.1	C	23.1	m#198		
			Steilacoom-DuPont NB-T	610	F	98.5	F	98.5	#1039	620					C	23.1	m#198
			Steilacoom-DuPont NB-R	0						0							
			Steilacoom-DuPont SB-L	0						0	C	33.8					
Steilacoom-DuPont SB-T	485	C	31.4	D	50.0	#318	925			D			47.7	#510			
Steilacoom-DuPont SB-R	290			A	0.2	0	385			A	0.4	0					

Intersection Analysis Summary - 2040 Revised Build

No.	Intersection	Control Type	Movement	AM PEAK HOUR						PM PEAK HOUR						
				Post-Process Volume (vph)	LOS	Delay (sec)	LOS	Delay (sec)	95th Queue (ft)	Post-Process Volume (vph)	LOS	Delay (sec)	LOS	Delay (sec)	95th Queue (ft)	
					Approach			Movement			Approach			Movement		
8	Steilacoom - DuPont Road / Barksdale Avenue / Wilmington Drive	Signal	Overall	2,460	D	50.3				2,415	C	28.5				
			Wilmington Drive EB-L	25			E	67.6	54	45			D	48.8	69	
			Wilmington Drive EB-T	75	E	63.1	E	62.0	136	110	D	53.4	D	55.0	157	
			Wilmington Drive EB-R	25			E	62.0	136	20			D	55.0	157	
			Steilacoom-DuPont WB-L	245			C	33.7	m137	180			D	43.1	m125	
			Steilacoom-DuPont WB-T	80	D	53.9	C	26.1	m40	110	D	47.3	D	39.1	m71	
			Steilacoom-DuPont WB-R	1,125			E	60.3	m214	530			E	50.5	m43	
			Steilacoom-DuPont NB-L	10			E	56.5	26	25	B	11.5	E	58.6	49	
			Steilacoom-DuPont NB-T	90	C	29.0	E	62.9	135	135			D	48.2	172	
			Steilacoom-DuPont NB-R	115			A	0.1	0	570			A	0.7	0	
			Barksdale Avenue SB-L	585			D	47.0	#483	620	B	17.7	C	24.3	320	
Barksdale Avenue SB-T	70	D	47.0	D	47.0	#486	50			B	11.1	311				
Barksdale Avenue SB-R	15			D	47.0	#486	20			B	11.1	311				
11	I-5 NB Ramps / 41st Division Drive (Main Gate)	Merge / Diverge	Overall	0	Cloverleaf merge/diverge Not Applicable for Synchro Analysis						Cloverleaf merge/diverge Not Applicable for Synchro Analysis					
			EB-R													
			WB-R													
			NB-T													
			NB-R													
			SB-T													
12	I-5 SB Ramps / 41st Division Drive (Main Gate)	Merge / Diverge	Overall		Cloverleaf merge/diverge Not Applicable for Synchro Analysis						Cloverleaf merge/diverge Not Applicable for Synchro Analysis					
			EB-R													
			WB-R													
			NB-L													
			NB-T													
			NB-R													
13	I-5 NB Ramps / Berkeley Avenue	RAB	Overall	2,865	A	4.5				2,520	A	4.6				
			I-5 Off-ramp EB-L	170			A	7.7	25	140			A	5.1	14	
			I-5 Off-ramp EB-T		A	1.7				0	A	3.1	A	5.1	14	
			I-5 Off-ramp EB-R	660			A	0.1	0	90			A			
			Berkeley Ave NB-T	265			A	5.7	31	735	A	4.9	A	8.8	99	
			Berkeley Ave NB-R	530			A	1.4	23	1,175			A	2.5	79	
			Berkeley Ave SB-T	1,155	A	7.6	A	7.6		380	A	3.9	A	3.9		
Berkeley Ave SB-R							0									
14	I-5 SB Ramps / Berkeley Avenue	RAB	Overall	1,995	B	16.7				1,475	A	8.7				
			I-5 Off-ramp WB-L	1,055			B	18.2	180	285			A	7.1	21	
			I-5 Off-ramp WB-T		B	18.1				5	A	7.1	A	6.7	21	
			I-5 Off-ramp WB-R	235			B	17.7	180	0			A	6.7	21	
			Berkeley Ave NB-L	140			A	4.2		535			A	6.4		
			Berkeley Ave NB-T	295	A	4.4	A	4.4		340	A	6.1	A	5.6		
			Berkeley Ave NB-R							0						
			Berkeley Ave SB-L							0						
Berkeley Ave SB-T	185	C	29.6	C	29.6	112	95	B	17.6	B	17.6	99				
Berkeley Ave SB-R	85			C	29.6	112	215			B	17.6	99				
15	Berkeley Avenue / Union Avenue	Two-way Stop Control	Overall	410	C	15.5				250	B	13.2				
			Militia Dr EB-L	10			C	15.5	4	5			B	13.5	1	
			Militia Dr EB-T	5	C	15.5	C	15.5	4		B	13.2				
			Militia Dr EB-R	0						0						
			Union Ave WB-L													
			Union Ave WB-T	5	A	9.3	A		0	5	A	8.9	A	8.9		
			Union Ave WB-R	180			A	9.3	19	60			A	8.9	5	
			Berkeley Ave SB-L	195			A	7.2	13	175			A	7.4	12	
Berkeley Ave SB-T		A	7.2	A	7.2	13		A	7.4							
Berkeley Ave SB-R	15						5			A	7.4	12				

Intersection Analysis Summary - 2040 Revised Build

No.	Intersection	Control Type	Movement	AM PEAK HOUR					PM PEAK HOUR							
				Post-Process Volume (vph)	LOS	Delay (sec)	LOS	Delay (sec)	95th Queue (ft)	Post-Process Volume (vph)	LOS	Delay (sec)	LOS	Delay (sec)	95th Queue (ft)	
				Approach		Movement			Approach		Movement					
16	Berkeley Avenue/ Jackson Extension (Interchange Ramp)		Overall	775	B	12.3				730	B	10.9				
			RAMP	EB-L	210			B	14.2	80	170			B	12.4	57
			RAMP	EB-T		B	14.2					B	12.4			
			RAMP	EB-R	165			B	14.2	80	170			B	12.4	57
			Berkeley Ave	NB-L	190			B	11.8	40	130			B	10.1	23
			Berkeley Ave	NB-T	50	B	11.1	A	8.2	7	65	A	9.5	A	8.3	10
			Berkeley Ave	NB-R												
			Berkeley Ave	SB-L												
			Berkeley Ave	SB-T	45	A	9.9	A	9.9	25	15	A	9.6	B	9.6	28
Berkeley Ave	SB-R	115			A	9.9	25	180			B	9.6	28			
17	Berkeley Avenue/ Washington Avenue	Two-way Stop Control on Washington Avenue	Overall	455	A	9.6				385	A	9.2				
			Washington Ave	WB-L							A	9.2				
			Washington Ave	WB-T		A	9.6									
			Washington Ave	WB-R	55			A	9.6	6	135			A	9.2	13
			Berkeley Ave	NB-L												
			Berkeley Ave	NB-T	185		0.0				60		0.0			
			Berkeley Ave	NB-R	5						5					
			Berkeley Ave	SB-L												
			Berkeley Ave	SB-T	210		0.0	A	0.0		185		0.0	A	0.0	
Berkeley Ave	SB-R															
18	I-5 NB Ramps / Thorne Lane	RAB	Overall	1,945	A	7.0				2,295	B	11.9				
			I-5 Off-ramp	EB-L	25			B	12.1	52	35			B	15.3	81
			I-5 Off-ramp	EB-T	0	B	12.1				5	B	15.3	B	15.3	81
			I-5 Off-ramp	EB-R	220			B	12.1	52	275			B	15.3	81
			Thorne Ln	NB-L	0						0					
			Thorne Ln	NB-T	585	A	7.1	B	10.9	134	720	B	15.1	C	25.1	400
			Thorne Ln	NB-R	320			A	0.0		475			A	0.1	
			Thorne Ln	SB-L	275			A	5.5		460			A	5.7	
			Thorne Ln	SB-T	520	A	5.4	A	5.3		325	A	5.6	A	5.3	
Thorne Ln	SB-R	0						0								
19	I-5 SB Ramps / Thorne Lane	Signal	Overall	1,765	B	12.6				2,010	B	17.7				
			I-5 Off-ramp	WB-L	475			B	13.7	163	265			B	14.5	104
			I-5 Off-ramp	WB-T	5	B	13.5	B	13.7	163	10	B	13.0	B	14.5	104
			I-5 Off-ramp	WB-R	310			B	13.2	163	335			B	11.8	107
			Thorne Ln	NB-L	430			A	9.3		655			B	12.4	
			Thorne Ln	NB-T	180	A	9.3	A	9.3		100	B	12.4	B	12.4	
			Thorne Ln	NB-R	0						0					
			Thorne Ln	SB-L	0			B	16.5	96	0					
			Thorne Ln	SB-T	320	B	16.3	B	14.7	96	520	C	28.2	C	28.9	256
Thorne Ln	SB-R	45						125			C	25.6	256			
20	Thorne Lane/Union Avenue	Tee with Stop Sign on Union Avenue	Overall	190	A	9.6				370	B	12.0				
			Union Ave	EB-L	5					30			B	12.0	6	
			Union Ave	EB-T		A	9.6					B	12.0			
			Union Ave	EB-R	0			A	9.6	1	0					
			Thorne Ln	NB-L	30			A	5.8	2	80			A	2.5	5
			Thorne Ln	NB-T	10	A	5.8		0.0		160	A	2.5	A	0.0	
			Thorne Ln	NB-R												
			Thorne Ln	SB-L												
			Thorne Ln	SB-T	0						0		0.0			
Thorne Ln	SB-R	145						100								
21	Thorne Lane / Union Avenue Loop	New RAB Intersection	Overall	860	A	6.9				1,140	A	9.1				
			Union Loop	WB-L	10			A	4.7	3	155			A	6.5	33
			Union Loop	WB-T		A	4.7					A	6.5	A	6.5	33
			Union Loop	WB-R	5			A	4.7	3	35					
			Thorne Ln	NB-L												
			Thorne Ln	NB-T	345	A	7.5	A	7.7	88	360	A	7.4	A	7.4	90
			Thorne Ln	NB-R	145			A	6.9	88	75			A	7.4	90
			Thorne Ln	SB-L	0			A	5.4	63	25			B	11.4	133
			Thorne Ln	SB-T	355	A	6.3	A	6.3	63	490	B	11.4	B	11.4	133
Thorne Ln	SB-R															

Intersection Analysis Summary - 2040 Revised Build

No.	Intersection	Control Type	Movement	AM PEAK HOUR						PM PEAK HOUR								
				Post-Process Volume (vph)	LOS	Delay (sec)	LOS	Delay (sec)	95th Queue (ft)	Post-Process Volume (vph)	LOS	Delay (sec)	LOS	Delay (sec)	95th Queue (ft)			
																Approach	Movement	
22	I-5 NB Ramps / Gravelly Lake Drive	Signal	Overall	1,405	C	26.1				1,845	D	50.2						
			I-5 Off-ramp	EB-L	615				D	43.4	#483	790			D	53.0	#668	
			I-5 Off-ramp	EB-T	0	D	40.6			D	37.8	336	5	D	53.0	D	52.5	#666
			I-5 Off-ramp	EB-R	100					D	37.8	336	25					
			Gravelly Lk Dr	NB-L	0								0					
			Gravelly Lk Dr	NB-T	120	D	47.9			D	47.9	85	410	F	105.7	F	105.7	#356
			Gravelly Lk Dr	NB-R	30					D	47.9	85	40					
			Gravelly Lk Dr	SB-L	435					A	0.9	m0	555	A	2.9	A	3.0	m2
			Gravelly Lk Dr	SB-T	105	A	0.8			A	0.0	m0	20			A	0.0	m0
Gravelly Lk Dr	SB-R	0								0								
23	I-5 SB Ramps / Gravelly Lake Drive	Signal	Overall	2,205	D	47.0				2,435	D	39.3						
			I-5 Off-ramp	WB-L	0							5			E	58.0	17	
			I-5 Off-ramp	WB-T	0	D	50.5						0	E	58.9			
			I-5 Off-ramp	WB-R	280					D	50.5	0	195			E	59.0	74
			Gravelly Lk Dr	NB-L	65					A	4.3	35	25					
			Gravelly Lk Dr	NB-T	670	A	4.3			A	4.3	35	1,175	B	14.1	B	14.1	m145
			Gravelly Lk Dr	NB-R	0								0					
			Gravelly Lk Dr	SB-L	0								0					
			Gravelly Lk Dr	SB-T	540	E	72.6			E	78.4	#706	565	E	68.4	F	85.6	#820
Gravelly Lk Dr	SB-R	650					E	67.8	329	470			D	39.8	260			
25	Gravelly Lake Drive / Pacific Highway	Signal	Overall	2,640	B	15.8				2,960	B	12.8						
			Pacific Hwy	WB-L	145				D	54.5	92	240			E	66.2	159	
			Pacific Hwy	WB-T		D	52.6							E	63.9			
			Pacific Hwy	WB-R	180				D	51.0	71	75			D	56.6	69	
			Gravelly Lk Dr	NB-L														
			Gravelly Lk Dr	NB-T	920	A	4.4			A	4.5	78	1,310	A	6.5	A	6.7	56
			Gravelly Lk Dr	NB-R	30					A	0.0	m0	60			A	2.4	m1
			Gravelly Lk Dr	SB-L	320					E	55.2	327	245			C	20.9	161
			Gravelly Lk Dr	SB-T	1,045	B	15.1			A	2.7	124	1,030	A	7.0	A	3.7	163
Gravelly Lk Dr	SB-R																	

Note: For Two-way Stop Control Intersections - Overall LOS and delay is based on worse approach/movement

Synchro Analysis for Signalized and non-signalized intersections

Sidra Analysis for roundabouts

Appendix G

Collision Summary of ISATe Model Results

This Page Intentionally Left Blank

Summary of ISATe model results per scenario

Study Year	Data Source	Scenario	Mainline		Ramps		Terminals		Total Crashes	Total Crashes Per MVM
			Crashes	Crashes Per MVM	Crashes	Crashes Per MVM	Crashes	Crashes Per MEV		
2014	Existing Data	No Build	330	0.88	52	2.16	10	0.11	392	1.09
2014	Model outputs	No Build	319	0.85	26	1.09	35	0.41	380	1.06
2020	Model outputs	No Build	364	0.89	27	1.13	40	0.39	431	1.11
2040	Model outputs	No Build	443	0.96	25	1.05	45	0.43	513	1.14
2020	Model outputs	Build	377	0.91	30	1.15	42	0.41	449	1.06
2040	Model outputs	Build	491	0.96	30	1.13	42	0.40	563	1.10

MVM = Million Vehicle Miles

MEV = Million Entering Vehicle