

Transmittal Number PT 11-058	Date July 2011
Publication Distribution To: Design Manual holders	
Publication Title Design Manual – July 2011	Publication Number M 22-01.08
Originating Organization WSDOT Design Office, Design Policy, Standards, and Safety Research Section	

Remarks and Instructions

What's changed in the Design Manual for July 2011?

For a summary of the 2011 Substantial Changes, Minor Changes, and Incorporated Errata, see page 3.

How do you stay connected to current design policy?

It's the designer's responsibility to apply current design policy when developing transportation projects at WSDOT. The best way to know what's current is to reference the manual online.

Download the current electronic WSDOT *Design Manual*, the latest revision package, or separate chapters at: <http://www.wsdot.wa.gov/publications/manuals/m22-01.htm>

Did you know?

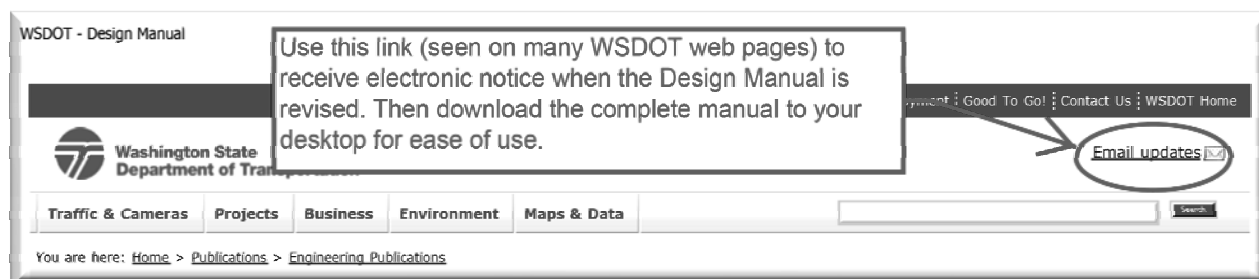

To get the latest information on WSDOT administrative and engineering manuals, sign up for e-mail updates for individual manuals at: <http://www.wsdot.wa.gov/publications/manuals/>

Distributed By Publications Services	Phone Number: 360-705-7430	Design Office Signature /s/ Pasco Bakotich III
---	-------------------------------	--

Remove/Insert instructions for those who still maintain a printed manual:

VOLUME 1		
CHAPTER	REMOVE PAGES	INSERT PAGES
Contents	1–16	1–16
Exhibits	17–32	17–32
100 Manual Description	100-3&4	100-3&4
130 Project Development Sequence	130-3&4, 9&10	130-3&4, 9&10
300 Design Documentation, Approval, and Process Review	300-1–22	300-1–22
305 Managing Projects (NEW CHAPTER)	N/A	305-1–8
310 Value Engineering	310-7&8	310-7&8
400 Surveying and Mapping	400-1–4	400-1–4
410 Monumentation	410-1–4	410-1–4
530 Limited Access Control	530-1&2, 9&10, 13–18	530-1&2, 9&10, 13–18
540 Managed Access Control	540-3–6, 13&14	540-3–6, 13&14
720 Bridges	720-3&4, 5&6, 9&10	720-3&4, 5&6, 9&10
730 Retaining Walls and Steep Reinforced Slopes	730-31&32	730-31&32
800 Hydraulic Design	800-1&2	800-1&2
920 Vegetation	920-3&4	920-3&4
930 Irrigation	930-1&2	930-1&2
1010 Work Zone Safety and Mobility	1010-17&18	1010-17&18
1020 Signing	1020-1–4	1020-1–4
1040 Illumination	1040-3–6, 9&10	1040-3–6, 9&10
1050 Intelligent Transportation Systems	1050-5&6	1050-5&6
VOLUME 2		
CHAPTER	REMOVE PAGES	INSERT PAGES
Contents	1–16	1–16
Exhibits	17–32	17–32
1100 Design Matrix Procedures	1100-3–8, 17–20	1100-3–8, 17–20
1120 Basic Design Level	1120-1–4	1120-1–4
1130 Modified Design Level	1130-15&16	1130-15&16
1140 Full Design Level	1140-1&2, 5–10, 13&14	1140-1&2, 5–10, 13&14
1220 Geometric Profile Elements	1220-3–6	1220-3–6
1230 Geometric Cross Section	1230-19&20	1230-19&20
1240 Turning Roadways	1240-3–8	1240-3–8
1270 Auxiliary Lanes	1270-5&6, 13–18, 21&22	1270-5&6, 13–18, 21&22
1310 Intersections at Grade	1310-3&4, 19&20, 37–40, 51&52, 55–58	1310-3&4, 19&20, 37–40, 51&52, 55–58
1320 Roundabouts	1320-1&2, 21&22	1320-1&2, 21&22
1330 Traffic Control Signals	1330-3&4, 9&10, 15–20, 23–26, 37&38	1330-3&4, 9&10, 15–20, 23–26, 37&38
1360 Interchanges	1360-1&2, 13–18, 23&24	1360-1&2, 13–18, 23&24
1370 Median Crossovers	1370-1–4	1370-1–4
1510 Pedestrian Facilities	1510-1–46	1510-1–44
1520 Roadway Bicycle Facilities	1520-1&2, 13&14	1520-1&2, 13&14
1600 Roadside Safety	1600-1–20	1600-1–22
1610 Traffic Barriers	1610-1–40	1610-1–42

Revision Marks

- A new date appears on the footer of each page that has changes or different pagination.
- Revision marks (underlines/sidebars) are used as a convenience to show designers what has changed.
- When a chapter is new (like 305) or substantially rewritten (like 1510), no revision marks are applied.

Summary of *Design Manual* Changes – July 2011 (Revisions merit careful study beyond this summary)

HIGHLIGHTS OF THE MORE SUBSTANTIAL CHANGES

Chapter 300 – Design Documentation, Approval, and Process Review

- Some common terms encountered in the *Design Manual* (such as document, consider, justify, desirable, minimum) have been defined in 300.03. This change should better inform designers on the intended level of documentation expected.
- Added guidance that a project-specific design matrix may be developed for projects not covered by the matrices in Chapter 1100.
- Made minor changes to NEPA and SEPA document names.

Chapter 305 – Managing Projects (new chapter)

- Developed a new chapter to heighten awareness and use of WSDOT's existing policies, tools, and resources related to project management, cost estimation and risk management, and context sensitive design.

Chapter 1100 – Design Matrix Procedures

- Added back the design element “Intersections/Ramp Terminals: Angle,” which was inadvertently omitted from the July 2010 revision.
- Revised Design Matrices 3, 4, and 5: “B” (which indicates basic design level) has been removed from all matrix columns, except for the column named “Basic Safety.” Where “B” was removed, Note [28] was added, directing designers to 1120.02.
- Replaced “accident” with “collision.”

Chapter 1120 – Basic Design Level

- Revised 1120.02 to better guide designers to topic-related chapters in the *Design Manual*.

Chapter 1370 – Median Crossovers

Updated guidance on median crossovers based on WSDOT and AASHTO criteria for:

- Locating new crossovers based on proximity to ramp tapers and structures.
- Decisions to widen shoulders at crossover locations where a narrow median exists (related to the design vehicle's ability to make the turn) and to document decisions to provide inside shoulders less than 10 feet wide.
- Designers to contact the HQ Access and Hearings Section to coordinate removal or relocation of existing crossovers and for proposed new crossovers.

Chapter 1510 – Pedestrian Facilities

Rewrote/reorganized to better emphasize federal and WSDOT criteria for pedestrian facilities.

- Addressed consistency of terminology throughout.
- Added new sections on Pedestrian Circulation Paths (PCPs) and Pedestrian Access Routes (PARs) as well as Exhibit 1510-2, which shows the difference between them. This discussion is important because the remainder of the chapter uses these phrases and directs the designer back to these sections for criteria.
- Removed all outdated guidance from ADAAG.
- Added requirements necessary to achieve compliance (examples: ½-inch maximum opening in joints and grates located in walkway, and no grates or utility objects allowed in ramps, landings, or ramp connections to gutter).

- Removed ADA table at end of chapter. Added sections up front that address ADA requirements. Referred back to those sections within the chapter.
- Updated/replaced/renumbered many exhibits.
- Exhibit 1510-14, Unmarked Crosswalks, depicts the legal definition of crosswalks based on presence of various sidewalks, shoulders, and lane line extensions.
- Replaced the midblock pedestrian crossing exhibit with a photograph of a different example.

Chapter 1600 – Roadside Safety

Revised design guidance in 1600.07 related to roadway, centerline, and shoulder rumble strips.

- Made the majority of changes in 1600.07.
- Added guidance to consult with RME and WSDOT Pavement Policy when rumble strips are proposed. Added guidance related to surfacing conditions and prep for areas where resurfacing may require replacement of rumble strips.
- Added or revised several definitions in 1600.03
- Added guidance in 1600.04 related to when the Design Clear Zone falls outside of right of way.
- Clarified in 1600.04(2) that AASHTO’s 18-inch operational offset is a lateral clearance for car doors and is not an acceptable design safety criterion for the Design Clear Zone.
- The state average run-off-the-road rate, used as guidance in considering shoulder rumble strips for undivided highways, was verified using current data.
- Revised centerline rumble strip guidance, which was informed by the March 2011 WSDOT Research Report, “Performance Analysis of Centerline Rumble Strips in Washington State,” available here: <http://www.wsdot.wa.gov/Research/Reports/700/768.1.htm>

Chapter 1610 – Traffic Barrier

- Updated W-beam barrier height criteria and the associated use of weak post curved guardrail systems to better reflect current FHWA guidance.
- Added new language and Exhibit 1610-13c to help designers determine cable barrier length of need requirements.
- Added language to reflect the current market conditions concerning the availability of weathering steel guardrail components.
- Updated text to reflect and clarify current policy and standards.
- Edited text and rearranged some paragraphs for clarity and readability.

MINOR REVISIONS AND TECHNICAL ERRATA

Many of these chapters have minor revisions based on of one or more of the following:

- Newly defined terms (such as consider, justify, document) in Chapter 300 necessitated rewording sentences in various other *Design Manual* chapters.
- Replaced the word “accident” with “collision” or “crash” in many instances, or a sentence was simply reworded in some other way.
- Changed office name.
- Removed PALS acronym.

Chapter 100 – Manual Description

- Added the new Chapter 305, Managing Projects.

Chapter 130 – Project Development Sequence

- Removed definition for pedestrian accident location (PAL).
- Made minor word changes based on Chapter 300 terms.

Chapter 310 – Value Engineering

- Replaced “accident” with “collision.”

Chapter 400 – Surveying and Mapping and Chapter 410 – Monumentation

- Changed the name of the HQ Geographic Services Office to GeoMetrix.

Chapter 530 – Limited Access Control

- Revised sections 530.09(2), Requirements, and (3), Restrictions, because each had text that belonged in the other’s section. Made other minor changes.

Chapter 540 – Managed Access Control

- Made changes related to Chapter 300 terms.

Chapter 720 – Bridges

- Added guidance related to vertical clearance for new structures, with consideration of overheight loads and with respect to avoiding a new corridor “low point” post-construction.
- Made other minor word changes.

Chapter 730 – Retaining Walls and Steep Reinforced Slopes

- Technical errata: corrected Exhibit 730-13b, which had an incorrect symbol in the upper right of the flow chart at the Wall Height decision diamond.

Chapter 800 – Hydraulic Design

- Made minor word change related to Chapter 300 terms.

Chapter 920 – Vegetation

- Replaced “accident” with “collision.”

Chapter 930 – Irrigation

- Revised sentence about proprietary device selections.

Chapter 1010 – Work Zone Safety and Mobility

- Made minor word changes based on Chapter 300 terms.

Chapter 1020 – Signing

- Made minor word changes based on Chapter 300 terms.
- Deleted sentence in 1020.01, which read: Provide standard signing on projects with either a “B” (basic design level) or EU (evaluate upgrade) matrix designation.

Chapter 1040 – Illumination

- Replaced “accident” with “collision.”
- Removed “PAL” statement.
- Removed out of place guidance, which read: Consider other minor safety work as necessary.

Chapter 1050 – Intelligent Transportation Systems

- Corrected the title of Exhibit 1050-2.
- Corrected Exhibit 1130-12a, which had arrowheads missing.

Chapter 1140 – Full Design Level

- Added back “1140.18, Traffic Signal Control, Illumination, and Intelligent Transportation Systems (ITS)” to the chapter “Contents” section, which was inadvertently omitted from the July 2010 revision.
- Made minor word changes based on Chapter 300 terms.

Chapter 1220 – Geometric Profile Elements

- Made minor word changes based on Chapter 300 terms.

Chapter 1230 – Geometric Cross Section

- Made minor word changes based on Chapter 300 terms.

Chapter 1240 – Turning Roadways

- Corrected Exhibits 1240-1a, 2a, and 3a, which all had arrowheads and fill missing.

Chapter 1270 – Auxiliary Lanes

- Corrected Exhibits 1270-2b, 6, 7, 8, 9, 13 and 14, which all had arrowheads and fill missing.

Chapter 1310 – Intersections at Grade

- Technical errata: Replaced a “plus” sign with the correct “minus” sign in Exhibit 1310-27b.

Chapter 1320 – Roundabouts

- Made minor word changes based on Chapter 300 terms.

Chapter 1330 – Traffic Control Signals

- Corrected Exhibits 1330-2, 6b, 7, and 8, which all had arrowheads missing.

Chapter 1360 – Interchanges

- Made minor word changes based on Chapter 300 terms.

Chapter 1520 – Roadway Bicycle Facilities

- Revised pages 1510-1 and 1510-2 to highlight the AASHTO reference *Guide for the Development of Bicycle Facilities*.
- Made minor change to Exhibits 1520-8a and 8b, which now show all shoulder arrows filled black.



Design Manual

Volume 1 – Procedures

M 22-01.08

July 2011

Division 1 – General Information
Division 2 – Hearings, Environmental, and Permits
Division 3 – Project Documentation
Division 4 – Surveying
Division 5 – Right of Way and Access Control
Division 6 – Soils and Paving
Division 7 – Structures
Division 8 – Hydraulics
Division 9 – Roadside Development
Division 10 – Traffic Safety Elements

Environmental and Engineering Programs

Design Office

Americans with Disabilities Act (ADA) Information

Materials can be provided in alternative formats by calling the ADA Compliance Manager at 360-705-7097. Persons who are deaf or hard of hearing may contact that number via the Washington Relay Service at 7-1-1.

Title VI Notice to Public

It is Washington State Department of Transportation (WSDOT) policy to ensure no person shall, on the grounds of race, color, national origin, or sex, as provided by Title VI of the Civil Rights Act of 1964, be excluded from participation in, be denied the benefits of, or be otherwise discriminated against under any of its federally funded programs and activities. Any person who believes his/her Title VI protection has been violated may file a complaint with WSDOT's Office of Equal Opportunity (OEO). For Title VI complaint forms and advice, please contact OEO's Title VI Coordinator at 360-705-7098 or 509-324-6018.

To get the latest information on WSDOT administrative and engineering manuals, sign up for individual manual e-mail updates at www.wsdot.wa.gov/publications/manuals.

Washington State Department of Transportation
Publications Services
PO Box 47304
Olympia, WA 98504-7304

Phone: 360-705-7430
E-mail: engrpubs@wsdot.wa.gov
Internet: www.wsdot.wa.gov/publications/manuals

Division 1 – General Information

- Chapter 100 Manual Description**
 - 100.01 Purpose
 - 100.02 Presentation and Revisions
 - 100.03 Manual Applications
 - 100.04 Manual Use
 - 100.05 Manual Organization

- Chapter 110 Design-Build Projects**
 - 110.01 General
 - 110.02 References
 - 110.03 Terminology and Language Used
 - 110.04 Design and Documentation Responsibility

- Chapter 120 Planning**
 - 120.01 General
 - 120.02 References
 - 120.03 Acronyms and Definitions
 - 120.04 Legislation and Policy Development
 - 120.05 Planning at WSDOT
 - 120.06 Linking Transportation Plans
 - 120.07 Linking WSDOT Planning to Programming

- Chapter 130 Project Development Sequence**
 - 130.01 General
 - 130.02 References
 - 130.03 Definitions
 - 130.04 Project Development Sequence

Division 2 – Hearings, Environmental, and Permits

- Chapter 210 Public Involvement and Hearings**
 - 210.01 General
 - 210.02 References
 - 210.03 Definitions
 - 210.04 Public Involvement
 - 210.05 Public Hearings
 - 210.06 Environmental Hearing
 - 210.07 Corridor Hearing
 - 210.08 Design Hearing
 - 210.09 Limited Access Hearing
 - 210.10 Combined Hearings
 - 210.11 Administrative Appeal Hearing
 - 210.12 Follow-Up Hearing
 - 210.13 Documentation

Chapter 220	Project Environmental Documentation
220.01	General
220.02	References
220.03	Definitions/Acronyms
220.04	Determining the Environmental Documentation
220.05	Identifying the Project Classification
220.06	Environmental Impact Statements: Class I Projects
220.07	Categorical Exclusions: Class II Projects
220.08	Environmental Assessments: Class III Projects
220.09	Reevaluations
220.10	Commitment File
220.11	Documentation

Chapter 230	Environmental Permits and Approvals
230.01	General
230.02	Permits and Approvals
230.03	Project Types and Permits
230.04	Design Process and Permit Interaction

Division 3 – Project Documentation

Chapter 300	Design Documentation, Approval, and Process Review
300.01	General
300.02	References
300.03	Definitions
300.04	Design Documentation
300.05	Project Development
300.06	FHWA Approval
300.07	Design Approval
300.08	Project Development Approval
300.09	Process Review

Chapter 305	Managing Projects
305.01	Introduction
305.02	References
305.03	Definitions
305.04	Design Project Management Overview
305.05	Cost Estimating for Design Project Development
305.06	Value Engineering
305.07	Context Sensitive Design (CSS)
305.08	Additional Design Resources

Chapter 310	Value Engineering
310.01	General
310.02	References
310.03	Definitions
310.04	Procedure
310.05	Documentation

Chapter 320	Traffic Analysis
320.01	General
320.02	References
320.03	Design Year
320.04	Definitions
320.05	Travel Forecasting (Transportation Modeling)
320.06	Traffic Analysis

- 320.07 Scope of Traffic Impact Analysis
- 320.08 Traffic Data
- 320.09 Traffic Impact Analysis Methodologies
- 320.10 Traffic Analysis Software
- 320.11 Mitigation Measures
- 320.12 Traffic Impact Analysis Report

Division 4 – Surveying

Chapter 400 Surveying and Mapping

- 400.01 General
- 400.02 References
- 400.03 Procedures
- 400.04 Datums
- 400.05 Global Positioning System
- 400.06 WSDOT Survey Monument Database
- 400.07 Geographic Information System
- 400.08 Photogrammetric Surveys
- 400.09 Documentation

Chapter 410 Monumentation

- 410.01 General
- 410.02 References
- 410.03 Definitions
- 410.04 Control Monuments
- 410.05 Alignment Monuments
- 410.06 Property Corners
- 410.07 Other Monuments
- 410.08 Filing Requirements
- 410.09 Documentation

Division 5 – Right of Way and Access Control

Chapter 510 Right of Way Considerations

- 510.01 General
- 510.02 References
- 510.03 Special Features
- 510.04 Easements and Permits
- 510.05 Programming for Funds
- 510.06 Appraisal and Acquisition
- 510.07 Transactions
- 510.08 Documentation

Chapter 520 Access Control

- 520.01 General
- 520.02 References
- 520.03 Definitions
- 520.04 Vocabulary

Chapter 530 Limited Access Control

- 530.01 General
- 530.02 Achieving Limited Access
- 530.03 Full Control (Most Restrictive)
- 530.04 Partial Control
- 530.05 Modified Control (Least Restrictive)
- 530.06 Access Approaches

- 530.07 Frontage Roads
- 530.08 Turnbacks
- 530.09 Adjacent Railroads
- 530.10 Modifications to Limited Access Highways
- 530.11 Documentation

Chapter 540 Managed Access Control

- 540.01 General
- 540.02 References
- 540.03 Definitions
- 540.04 Design Considerations
- 540.05 Managed Access Highway Classes
- 540.06 Corner Clearance Criteria
- 540.07 Access Connection Categories
- 540.08 Access Connection Permit
- 540.09 Permitting and Design Documentation
- 540.10 Other Considerations
- 540.11 Preconstruction Conference
- 540.12 Adjudicative Proceedings
- 540.13 Documentation

Chapter 550 Interchange Justification Report

- 550.01 General
- 550.02 References
- 550.03 Definitions
- 550.04 Procedures
- 550.05 Interchange Justification Report and Supporting Analyses
- 550.06 Report Organization and Appendices
- 550.07 Updating an IJR
- 550.08 Documentation

Chapter 560 Fencing

- 560.01 General
- 560.02 References
- 560.03 Design Criteria
- 560.04 Fencing Types
- 560.05 Gates
- 560.06 Procedure
- 560.07 Documentation

Division 6 – Soils and Paving

Chapter 610 Investigation of Soils, Rock, and Surfacing Materials

- 610.01 General
- 610.02 References
- 610.03 Materials Sources
- 610.04 Geotechnical Investigation, Design, and Reporting
- 610.05 Use of Geotechnical Consultants
- 610.06 Geotechnical Work by Others
- 610.07 Surfacing Report
- 610.08 Documentation

Chapter 620 Design of Pavement Structure

- 620.01 General
- 620.02 Estimating Tables

- Chapter 630 Geosynthetics**
630.01 General
630.02 References
630.03 Geosynthetic Types and Characteristics
630.04 Geosynthetic Function Definitions and Applications
630.05 Design Approach for Geosynthetics
630.06 Design Responsibility
630.07 Documentation

Division 7 – Structures

- Chapter 700 Project Development Roles and Responsibilities for Projects With Structures**
700.01 General
700.02 Procedures
- Chapter 710 Site Data for Structures**
710.01 General
710.02 References
710.03 Required Data for All Structures
710.04 Additional Data for Waterway Crossings
710.05 Additional Data for Grade Separations
710.06 Additional Data for Widening
710.07 Documentation
- Chapter 720 Bridges**
720.01 General
720.02 References
720.03 Bridge Locations
720.04 Bridge Site Design Elements
720.05 Documentation
- Chapter 730 Retaining Walls and Steep Reinforced Slopes**
730.01 General
730.02 References
730.03 Design Principles
730.04 Design Requirements
730.05 Guidelines for Wall/Slope Selection
730.06 Design Responsibility and Process
730.07 Documentation
- Chapter 740 Noise Barriers**
740.01 General
740.02 References
740.03 Design
740.04 Procedures
740.05 Documentation

Division 8 – Hydraulics

- Chapter 800 Hydraulic Design**
800.01 General
800.02 References
800.03 Hydraulic Considerations
800.04 Safety Considerations
800.05 Design Responsibility
800.06 Documentation

Division 9 – Roadside Development

- Chapter 900 Roadside Development**
 - 900.01 General
 - 900.02 References
 - 900.03 Legal Requirements
 - 900.04 Roadside Classification Plan
 - 900.05 Roadside Manual
 - 900.06 Project Development
 - 900.07 Documentation

- Chapter 910 Contour Grading**
 - 910.01 General
 - 910.02 References
 - 910.03 Procedures
 - 910.04 Recommendations
 - 910.05 Documentation

- Chapter 920 Vegetation**
 - 920.01 General
 - 920.02 References
 - 920.03 Discussion
 - 920.04 Design Guidelines
 - 920.05 Documentation

- Chapter 930 Irrigation**
 - 930.01 General
 - 930.02 References
 - 930.03 Design Considerations
 - 930.04 Documentation

- Chapter 940 Soil Bioengineering**
 - 940.01 General
 - 940.02 References
 - 940.03 Uses for Soil Bioengineering
 - 940.04 Design Responsibilities and Considerations
 - 940.05 Documentation

- Chapter 950 Public Art**
 - 950.01 General
 - 950.02 References
 - 950.03 Definitions
 - 950.04 Standard Architectural Design
 - 950.05 Criteria for Public Art
 - 950.06 Process and Project Delivery Timing
 - 950.07 Approvals
 - 950.08 Documentation

Division 10 – Traffic Safety Elements

Chapter 1010 Work Zone Safety and Mobility

- 1010.01 General
- 1010.02 References
- 1010.03 Definitions
- 1010.04 Work Zone Safety and Mobility
- 1010.05 Transportation Management Plans and Significant Projects
- 1010.06 Work Zone TMP Strategy Development
- 1010.07 Capacity Analysis
- 1010.08 Work Zone Design Standards
- 1010.09 Temporary Traffic Control Devices
- 1010.10 Other Traffic Control Devices or Features
- 1010.11 Traffic Control Plan Development and PS&E
- 1010.12 Training and Resources
- 1010.13 Documentation

Chapter 1020 Signing

- 1020.01 General
- 1020.02 References
- 1020.03 Design Components
- 1020.04 Overhead Installation
- 1020.05 State Highway Route Numbers
- 1020.06 Mileposts
- 1020.07 Guide Sign Plan
- 1020.08 Documentation

Chapter 1030 Delineation

- 1030.01 General
- 1030.02 References
- 1030.03 Definitions
- 1030.04 Pavement Markings
- 1030.05 Guideposts
- 1030.06 Barrier Delineation
- 1030.07 Object Markers
- 1030.08 Wildlife Warning Reflectors
- 1030.09 Documentation

Chapter 1040 Illumination

- 1040.01 General
- 1040.02 References
- 1040.03 Definitions
- 1040.04 Design Considerations
- 1040.05 Required Illumination
- 1040.06 Additional Illumination
- 1040.07 Design Criteria
- 1040.08 Documentation

Chapter 1050 Intelligent Transportation Systems

- 1050.01 General
- 1050.02 References
- 1050.03 Systems Engineering
- 1050.04 Documentation

Division 11 – Project Design Criteria**Chapter 1100 Design Matrix Procedures**

- 1100.01 General
- 1100.02 Selecting a Design Matrix
- 1100.03 Using a Design Matrix

Chapter 1110 Minor Operational Enhancement Projects

- 1110.01 General
- 1110.02 References
- 1110.03 Definitions
- 1110.04 Minor Operational Enhancement Matrix Procedures
- 1110.05 Selecting a Minor Operational Enhancement Matrix
- 1110.06 Project Type
- 1110.07 Using a Minor Operational Enhancement Matrix
- 1110.08 Project Approval
- 1110.09 Documentation

Chapter 1120 Basic Design Level

- 1120.01 General
- 1120.02 Basic Safety
- 1120.03 Minor Safety and Minor Preservation Work
- 1120.04 Documentation

Chapter 1130 Modified Design Level

- 1130.01 General
- 1130.02 Design Speed
- 1130.03 Alignment
- 1130.04 Roadway Widths
- 1130.05 Cross Slopes
- 1130.06 Sideslopes
- 1130.07 Bike and Pedestrian
- 1130.08 Bridges
- 1130.09 Intersections
- 1130.10 Documentation

Chapter 1140 Full Design Level

- 1140.01 General
- 1140.02 References
- 1140.03 Definitions
- 1140.04 Functional Classification
- 1140.05 Terrain Classification
- 1140.06 Geometric Design Data
- 1140.07 Design Speed
- 1140.08 Traffic Lanes
- 1140.09 Shoulders
- 1140.10 Medians
- 1140.11 Curbs
- 1140.12 Parking
- 1140.13 Pavement Type
- 1140.14 Structure Width

- 1140.15 Right of Way Width
- 1140.16 Grades
- 1140.17 Fencing
- 1140.18 Traffic Signal Control, Illumination, and Intelligent Transportation Systems (ITS)
- 1140.19 Documentation

Division 12 – Geometrics

Chapter 1210 Geometric Plan Elements

- 1210.01 General
- 1210.02 References
- 1210.03 Definitions
- 1210.04 Horizontal Alignment
- 1210.05 Distribution Facilities
- 1210.06 Number of Lanes and Arrangement
- 1210.07 Pavement Transitions
- 1210.08 Procedures
- 1210.09 Documentation

Chapter 1220 Geometric Profile Elements

- 1220.01 General
- 1220.02 References
- 1220.03 Vertical Alignment
- 1220.04 Coordination of Vertical and Horizontal Alignments
- 1220.05 Airport Clearance
- 1220.06 Railroad Crossings
- 1220.07 Procedures
- 1220.08 Documentation

Chapter 1230 Geometric Cross Section

- 1230.01 General
- 1230.02 References
- 1230.03 Definitions
- 1230.04 Roadways
- 1230.05 Medians and Outer Separations
- 1230.06 Roadsides
- 1230.07 Roadway Sections
- 1230.08 Documentation

Chapter 1240 Turning Roadways

- 1240.01 General
- 1240.02 References
- 1240.03 Definitions
- 1240.04 Turning Roadway Widths
- 1240.05 Documentation

Chapter 1250 Superelevation

- 1250.01 General
- 1250.02 References
- 1250.03 Definitions
- 1250.04 Superelevation Rate Selection
- 1250.05 Existing Curves
- 1250.06 Turning Movements at Intersections
- 1250.07 Runoff for Highway Curves
- 1250.08 Runoff for Ramp Curves
- 1250.09 Documentation

Chapter 1260 Sight Distance

- 1260.01 General
- 1260.02 References
- 1260.03 Definitions
- 1260.04 Stopping Sight Distance
- 1260.05 Passing Sight Distance
- 1260.06 Decision Sight Distance
- 1260.07 Documentation

Chapter 1270 Auxiliary Lanes

- 1270.01 General
- 1270.02 References
- 1270.03 Definitions
- 1270.04 Climbing Lanes
- 1270.05 Passing Lanes
- 1270.06 Slow-Moving Vehicle Turnouts
- 1270.07 Shoulder Driving for Slow Vehicles
- 1270.08 Emergency Escape Ramps
- 1270.09 Chain-Up and Chain-Off Areas
- 1270.10 Documentation

Division 13 – Intersections and Interchanges**Chapter 1310 Intersections at Grade**

- 1310.01 General
- 1310.02 References
- 1310.03 Definitions
- 1310.04 Intersection Configurations
- 1310.05 Design Considerations
- 1310.06 Design Vehicle Selection
- 1310.07 Design Elements
- 1310.08 U-Turns
- 1310.09 Intersection Sight Distance
- 1310.10 Traffic Control at Intersections
- 1310.11 Signing and Delineation
- 1310.12 Procedures
- 1310.13 Documentation

Chapter 1320 Roundabouts

- 1320.01 General
- 1320.02 References
- 1320.03 Definitions
- 1320.04 Roundabout Types
- 1320.05 Capacity Analysis
- 1320.06 Geometric Design
- 1320.07 Pedestrians
- 1320.08 Bicycles
- 1320.09 Signing and Pavement Marking
- 1320.10 Illumination
- 1320.11 Access, Parking, and Transit Facilities
- 1320.12 Design Procedures
- 1320.13 Documentation

Chapter 1330	Traffic Control Signals
1330.01	General
1330.02	References
1330.03	Definitions
1330.04	Procedures
1330.05	Signal Warrants
1330.06	Conventional Traffic Signal Design
1330.07	Documentation
Chapter 1340	Road Approaches
1340.01	General
1340.02	References
1340.03	Definitions
1340.04	Design Considerations
1340.05	Road Approach Design Template
1340.06	Sight Distance
1340.07	Road Approach Location
1340.08	Drainage
1340.09	Procedures
1340.10	Documentation
Chapter 1350	Railroad Grade Crossings
1350.01	General
1350.02	References
1350.03	Plans
1350.04	Traffic Control Systems
1350.05	Nearby Roadway Intersections
1350.06	Pullout Lanes
1350.07	Crossing Surfaces
1350.08	Crossing Closure
1350.09	Traffic Control During Construction and Maintenance
1350.10	Railroad Grade Crossing Petitions and WUTC Orders
1350.11	Grade Crossing Improvement Projects
1350.12	Light Rail
1350.13	Documentation
Chapter 1360	Interchanges
1360.01	General
1360.02	References
1360.03	Definitions
1360.04	Interchange Design
1360.05	Ramps
1360.06	Interchange Connections
1360.07	Ramp Terminal Intersections at Crossroads
1360.08	Interchanges on Two-Lane Highways
1360.09	Interchange Plans for Approval
1360.10	Documentation
Chapter 1370	Median Crossovers
1370.01	General
1370.02	Analysis
1370.03	Design
1370.04	Plan Updates and Approvals
1370.05	Documentation

Division 14 – HOV and Transit

Chapter 1410 High-Occupancy Vehicle Facilities

- 1410.01 General
- 1410.02 References
- 1410.03 Definitions
- 1410.04 Preliminary Design and Planning
- 1410.05 Operations
- 1410.06 Design Criteria
- 1410.07 Documentation

Chapter 1420 HOV Direct Access

- 1420.01 General
- 1420.02 References
- 1420.03 Definitions
- 1420.04 HOV Access Types and Locations
- 1420.05 Direct Access Geometrics
- 1420.06 Passenger Access
- 1420.07 Traffic Design Elements
- 1420.08 Documentation

Chapter 1430 Transit Facilities

- 1430.01 General
- 1430.02 References
- 1430.03 Definitions
- 1430.04 Park & Ride Lots
- 1430.05 Transfer/Transit Centers
- 1430.06 Bus Stops and Pullouts
- 1430.07 Passenger Amenities
- 1430.08 Roadway Design and Design Vehicle Characteristics
- 1430.09 Intersection Radii
- 1430.10 Universal Access
- 1430.11 Documentation

Division 15 – Pedestrian and Bicycle Facilities

Chapter 1510 Pedestrian Facilities

- 1510.01 General
- 1510.02 References
- 1510.03 Definitions
- 1510.04 Policy
- 1510.05 ADA Requirements by Project Type
- 1510.06 Pedestrian Circulation Paths
- 1510.07 Pedestrian Access Routes
- 1510.08 Sidewalks
- 1510.09 Curb Ramps
- 1510.10 Crosswalks
- 1510.11 Raised Medians/Traffic Islands
- 1510.12 Pedestrian Push Buttons at Signals
- 1510.13 At-Grade Railroad Crossings
- 1510.14 Pedestrian Grade Separations (Structures)
- 1510.15 Other Pedestrian Facilities
- 1510.16 Illumination and Signing
- 1510.17 Work Zone Pedestrian Accommodation
- 1510.18 Documentation

- Chapter 1515 Shared-Use Paths**
 - 1515.01 General
 - 1515.02 Definitions
 - 1515.03 Shared-Use Path Design
 - 1515.04 Documentation

- Chapter 1520 Roadway Bicycle Facilities**
 - 1520.01 General
 - 1520.02 References
 - 1520.03 Definitions
 - 1520.04 Facility Selection
 - 1520.05 Project Requirements
 - 1520.06 Shared-Use Path Design
 - 1520.07 Shared Roadway Bicycle Facility Design
 - 1520.08 Signed Shared Bicycle Roadway Design
 - 1520.09 Bicycle Lane Design
 - 1520.10 Documentation

Division 16 – Roadside Safety Elements

- Chapter 1600 Roadside Safety**
 - 1600.01 General
 - 1600.02 References
 - 1600.03 Definitions
 - 1600.04 Clear Zone
 - 1600.05 Features to Be Considered for Mitigation
 - 1600.06 Median Considerations
 - 1600.07 Other Roadside Safety Features
 - 1600.08 Documentation

- Chapter 1610 Traffic Barriers**
 - 1610.01 General
 - 1610.02 References
 - 1610.03 Definitions
 - 1610.04 Project Criteria
 - 1610.05 Barrier Design
 - 1610.06 Beam Guardrail
 - 1610.07 Cable Barrier
 - 1610.08 Concrete Barrier
 - 1610.09 Special-Use Barriers
 - 1610.10 Bridge Traffic Barriers
 - 1610.11 Other Barriers
 - 1610.12 Documentation

- Chapter 1620 Impact Attenuator Systems**
 - 1620.01 General
 - 1620.02 Design Criteria
 - 1620.03 Selection
 - 1620.04 Documentation

Division 17 – Roadside Facilities

Chapter 1710 Safety Rest Areas and Traveler Services

- 1710.01 General
- 1710.02 References
- 1710.03 Documentation

Chapter 1720 Weigh Sites

- 1720.01 General
- 1720.02 Definitions
- 1720.03 Planning, Development, and Responsibilities
- 1720.04 Permanent Facilities
- 1720.05 Portable Facilities
- 1720.06 Shoulder Sites
- 1720.07 Federal Participation
- 1720.08 Procedures
- 1720.09 Documentation

Exhibit 110-1	Design Documentation Sequence for a Typical Design-Build Project
Exhibit 120-1	Relationship Between Transportation Plans and Planning Organizations
Exhibit 120-2	Transportation Improvement Programs
Exhibit 120-3	Linking Planning and Programming
Exhibit 130-1	Program Elements: Highway Preservation
Exhibit 130-2	Program Elements: Highway Improvement
Exhibit 130-3	Highway System Plan Implementation
Exhibit 210-1	Types of Public Hearings
Exhibit 210-2	Public Hearing Formats
Exhibit 210-3	Prehearing Packet Checklist
Exhibit 210-4	Sequence for Corridor, Design, and Environmental Hearings
Exhibit 210-5	Sequence for Limited Access Hearing
Exhibit 210-6	Hearing Summary Approvals
Exhibit 230-1	Project Environmental Matrix 1: Permit Probabilities for Interstate Routes (Main Line)
Exhibit 230-2	Project Environmental Matrix 2: Permit Probabilities for Interstate Interchange Areas
Exhibit 230-3	Project Environmental Matrix 3: Permit Probabilities for NHS Routes, Non-Interstate (Main Line)
Exhibit 230-4	Project Environmental Matrix 4: Permit Probabilities for Interchange Areas, NHS (Except Interstate), and Non-NHS
Exhibit 230-5	Project Environmental Matrix 5: Non-NHS Routes (Main Line)
Exhibit 230-6	Endnotes for Project Environmental Matrices
Exhibit 230-7	Environmental Interrelationship: HMA/PCCP/BST Main Line Overlay
Exhibit 230-8	Environmental Interrelationship: Safety Corridor Channelization Main Line
Exhibit 300-1	Design Matrix Documentation Requirements
Exhibit 300-2	Design Approval Level
Exhibit 300-3	Approvals
Exhibit 300-4	PS&E Process Approvals
Exhibit 300-5	Common Components of Design Documentation Package
Exhibit 300-6	Evaluate Upgrade (EU) Documentation Contents List
Exhibit 300-7	Deviation Request and Project Analysis Contents List
Exhibit 300-8	Design to Construction Transition Project Turnover Checklist Example
Exhibit 305-1	WSDOT Project Management Process
Exhibit 310-1	Seven-Phase Job Plan for VE Studies
Exhibit 310-2	VE Study Team Tools
Exhibit 320-1	Measures of Effectiveness by Facility Type
Exhibit 400-1	Interagency Agreement

Exhibit 400-2	Report of Survey Mark Example
Exhibit 410-1	Monument Documentation Summary
Exhibit 410-2	DNR Permit Application
Exhibit 410-3	DNR Completion Report Form
Exhibit 410-4	Land Corner Record
Exhibit 510-1	Appraisal and Acquisition
Exhibit 520-1	Access Control Vocabulary
Exhibit 530-1a	Full Access Control Limits: Interchange
Exhibit 530-1b	Full Access Control Limits: Interchange
Exhibit 530-1c	Full Access Control Limits: Interchange With Roundabouts
Exhibit 530-1d	Full Access Control Limits: Ramp Terminal With Transition Taper
Exhibit 530-1e	Full Access Control Limits: Single Point Urban Interchange
Exhibit 530-2a	Partial Access Control Limits: At-Grade Intersections
Exhibit 530-2b	Partial Access Control Limits: Roundabout Intersections
Exhibit 530-3a	Modified Access Control Limits: Roundabout Intersections
Exhibit 530-3b	Modified Access Control Limits: Intersections
Exhibit 540-1	Minimum Corner Clearance: Distance From Access Connection to Public Road or Street
Exhibit 540-2	Managed Access Highway Class Description
Exhibit 550-1	Interstate Routes: Interchange Justification Report Content and Review Levels
Exhibit 550-2	Non-Interstate Routes: IJR Content and Review Levels
Exhibit 550-3	Interstate IJR: Process Flow Chart
Exhibit 550-4	Non-Interstate IJR: Process Flow Chart
Exhibit 550-5	IJR: Stamped Cover Sheet Example
Exhibit 610-1	Materials Source Development
Exhibit 620-1	Estimating: Miscellaneous Tables
Exhibit 620-2a	Estimating: Hot Mix Asphalt Pavement and Asphalt Distribution Tables
Exhibit 620-2b	Estimating: Asphalt Distribution Tables
Exhibit 620-3	Estimating: Bituminous Surface Treatment
Exhibit 620-4	Estimating: Base and Surfacing Typical Section Formulae and Example
Exhibit 620-5a	Estimating: Base and Surfacing Quantities
Exhibit 620-5b	Estimating: Base and Surfacing Quantities
Exhibit 620-5c	Estimating: Base and Surfacing Quantities
Exhibit 620-5d	Estimating: Base and Surfacing Quantities
Exhibit 620-5e	Estimating: Base and Surfacing Quantities
Exhibit 620-5f	Estimating: Base and Surfacing Quantities
Exhibit 620-5g	Estimating: Base and Surfacing Quantities
Exhibit 620-5h	Estimating: Base and Surfacing Quantities
Exhibit 630-1	Selection Criteria for Geotextile Class

Exhibit 630-2	Maximum Sheet Flow Lengths for Silt Fences
Exhibit 630-3	Maximum Contributing Area for Ditch and Swale Applications
Exhibit 630-4	Design Process for Drainage and Erosion Control: Geotextiles and Nonstandard Applications
Exhibit 630-5	Design Process for Separation, Soil Stabilization, and Silt Fence
Exhibit 630-6	Examples of Various Geosynthetics
Exhibit 630-7	Geotextile Application Examples
Exhibit 630-8	Definition of Slope Length
Exhibit 630-9	Definition of Ditch or Swale Storage Length and Width
Exhibit 630-10	Silt Fences for Large Contributing Area
Exhibit 630-11	Silt Fence End Treatment
Exhibit 630-12	Gravel Check Dams for Silt Fences
Exhibit 700-1	Determination of the Roles and Responsibilities for Projects With Structures: Project Development Phase
Exhibit 710-1	Bridge Site Plan Scales
Exhibit 710-2	Bridge Site Data Checklist
Exhibit 720-1	Bridge Vertical Clearances
Exhibit 720-2	Highway Structure Over Railroad
Exhibit 720-3	Embankment Slope at Bridge Ends
Exhibit 730-1	Summary of Mechanically Stabilized Earth (MSE) Gravity Wall/Slope Options Available
Exhibit 730-2	Summary of Prefabricated Modular Gravity Wall Options Available
Exhibit 730-3	Summary of Rigid Gravity and Semigravity Wall Options Available
Exhibit 730-4	Summary of Nongravity Wall Options Available
Exhibit 730-5	Summary of Anchored Wall Options Available
Exhibit 730-6	Other Wall/Slope Options Available
Exhibit 730-7	Typical Mechanically Stabilized Earth Gravity Walls
Exhibit 730-8	Typical Prefabricated Modular Gravity Walls
Exhibit 730-9	Typical Rigid Gravity, Semigravity Cantilever, Nongravity Cantilever, and Anchored Walls
Exhibit 730-10	Typical Rockery and Reinforced Slopes
Exhibit 730-11	MSE Wall Drainage Detail
Exhibit 730-12	Retaining Walls With Traffic Barriers
Exhibit 730-13a	Retaining Wall Design Process
Exhibit 730-13b	Retaining Wall Design Process: Proprietary
Exhibit 740-1	Standard Noise Wall Types
Exhibit 900-1	Funding Source Determines Extent of Restoration
Exhibit 940-1	Soil Bioengineering Design
Exhibit 1010-1	General Lane Closure Work Zone Capacity
Exhibit 1010-2	Minimum Work Zone Clear Zone Distance

Exhibit 1010-3	Transportation Management Plan Components Checklist
Exhibit 1010-4	Abrupt Edge Pavement Drop-Off Protection
Exhibit 1020-1	Reflective Sheeting Requirements for Overhead Signs
Exhibit 1020-2	Timber Posts
Exhibit 1020-3	Wide Flange Steel Posts
Exhibit 1020-4	Laminated Wood Box Posts
Exhibit 1030-1	Pavement Marking Material Guide
Exhibit 1030-2	Guidepost Placement
Exhibit 1040-1a	Freeway Lighting Applications
Exhibit 1040-1b	Freeway Lighting Applications
Exhibit 1040-1c	Freeway Lighting Applications
Exhibit 1040-2	Freeway Ramp Terminals
Exhibit 1040-3	Ramp With Meter
Exhibit 1040-4	Freeway-to-Freeway Connection
Exhibit 1040-5	HOT (High-Occupancy Toll) Lane Enter/Exit Zone
Exhibit 1040-6	Lane Reduction
Exhibit 1040-7	Add Lane
Exhibit 1040-8a	Intersection With Left-Turn Channelization: Divided Highway
Exhibit 1040-8b	Intersections With Left-Turn Channelization
Exhibit 1040-9	Intersections With Drop Lane/Right-Turn Lane Channelization
Exhibit 1040-10	Intersections With Traffic Signals
Exhibit 1040-11	Intersection Without Channelization
Exhibit 1040-12	Roundabout
Exhibit 1040-13	Railroad Crossing With Gates or Signals
Exhibit 1040-14	Midblock Pedestrian Crossing
Exhibit 1040-15	Transit Flyer Stop
Exhibit 1040-16	Major Parking Lot
Exhibit 1040-17	Minor Parking Lot
Exhibit 1040-18	Truck Weigh Site
Exhibit 1040-19	Safety Rest Area
Exhibit 1040-20	Chain-Up/Chain-Off Parking Area
Exhibit 1040-21	Tunnel
Exhibit 1040-22	Bridge Inspection Lighting System
Exhibit 1040-23	Traffic Split Around an Obstruction
Exhibit 1040-24	Construction Work Zone and Detour
Exhibit 1040-25	Light Levels and Uniformity Ratios
Exhibit 1050-1	Systems Engineering Process (“V” Diagram)
Exhibit 1050-2	ITS Project Systems Engineering Review Form (With Instructions)

Exhibit 1100-1	Design Matrix Selection Guide
Exhibit 1100-2	Sites With Potential for Improvement
Exhibit 1100-3	NHS Highways in Washington
Exhibit 1100-4	Design Matrix 1: Interstate Routes (Main Line)
Exhibit 1100-5	Design Matrix 2: Interstate Interchange Areas
Exhibit 1100-6	Design Matrix 3: Main Line NHS Routes (Except Interstate)
Exhibit 1100-7	Design Matrix 4: Interchange Areas, NHS (Except Interstate), and Non-NHS
Exhibit 1100-8	Design Matrix 5: Main Line Non-NHS Routes
Exhibit 1100-9	Design Matrix Notes
Exhibit 1110-1	Minor Operational Enhancement Matrix Selection Guide
Exhibit 1110-2	Minor Operational Enhancement Matrix 1: Interstate and NHS Freeway Routes
Exhibit 1110-3	Minor Operational Enhancement Matrix 2: NHS Nonfreeway Routes
Exhibit 1110-4	Minor Operational Enhancement Matrix 3: Non-NHS Routes
Exhibit 1110-5	Q Project Design Summary/Approval Template
Exhibit 1110-6	Refuge Lane for T-Intersections on Two-Lane Highways
Exhibit 1130-1	Desirable Design Speed
Exhibit 1130-2	Stopping Sight Distance: Modified Design Level
Exhibit 1130-3	Minimum Crest Vertical Curve Length: Modified Design Level
Exhibit 1130-4	Minimum Superelevation: Modified Design Level
Exhibit 1130-5	Side Friction Factor
Exhibit 1130-6	One-Way Roadway and Ramp Turning Roadway Widths: Modified Design Level
Exhibit 1130-7	Design Vehicles: Modified Design Level
Exhibit 1130-8	Evaluation for Stopping Sight Distance for Crest Vertical Curves: Modified Design Level
Exhibit 1130-9a	Evaluation for Stopping Sight Distance for Horizontal Curves: Modified Design Level
Exhibit 1130-9b	Evaluation for Stopping Sight Distance Obstruction for Horizontal Curves: Modified Design Level
Exhibit 1130-10	Multilane Highways and Bridges: Modified Design Level
Exhibit 1130-11	Two-Lane Highways and Bridges: Modified Design Level
Exhibit 1130-12a	Minimum Total Roadway Widths for Two-Lane Two-Way Highway Curves: Modified Design Level
Exhibit 1130-12b	Minimum Total Roadway Widths for Two-Lane Two-Way Highway Curves: Modified Design Level, Based on the Delta Angle
Exhibit 1130-13	Main Line Roadway Sections: Modified Design Level
Exhibit 1130-14	Ramp Roadway Sections: Modified Design Level
Exhibit 1140-1	Desirable Design Speed

Exhibit 1140-2	Minimum Shoulder Width
Exhibit 1140-3	Shoulder Width for Curbed Sections in Urban Areas
Exhibit 1140-4	Median Width
Exhibit 1140-5	Geometric Design Data: Interstate
Exhibit 1140-6	Geometric Design Data: Principal Arterial
Exhibit 1140-7	Geometric Design Data: Minor Arterial
Exhibit 1140-8	Geometric Design Data: Collector
Exhibit 1140-9	Geometric Design Data: Urban Managed Access Highways
Exhibit 1210-1	Maximum Angle Without Curve
Exhibit 1210-2a	Alignment Examples
Exhibit 1210-2b	Alignment Examples
Exhibit 1210-2c	Alignment Examples
Exhibit 1220-1	Grade Length
Exhibit 1220-2a	Coordination of Horizontal and Vertical Alignments
Exhibit 1220-2b	Coordination of Horizontal and Vertical Alignments
Exhibit 1220-2c	Coordination of Horizontal and Vertical Alignments
Exhibit 1220-3	Grading at Railroad Crossings
Exhibit 1230-1	Divided Highway Roadway Sections
Exhibit 1230-2	Undivided Multilane Highway Roadway Sections
Exhibit 1230-3	Two-Lane Highway Roadway Sections
Exhibit 1230-4a	Ramp Roadway Sections
Exhibit 1230-4b	Ramp Roadway Sections
Exhibit 1230-5a	Shoulder Details
Exhibit 1230-5b	Shoulder Details
Exhibit 1230-6a	Divided Highway Median Sections
Exhibit 1230-6b	Divided Highway Median Sections
Exhibit 1230-6c	Divided Highway Median Sections
Exhibit 1230-7a	Roadway Sections in Rock Cuts: Design A
Exhibit 1230-7b	Roadway Sections in Rock Cuts: Design B
Exhibit 1230-8	Roadway Sections With Stepped Slopes
Exhibit 1230-9a	Bridge End Slopes
Exhibit 1230-9b	Bridge End Slopes
Exhibit 1240-1a	Traveled Way Width for Two-Lane Two-Way Turning Roadways
Exhibit 1240-1b	Traveled Way Width for Two-Lane Two-Way Turning Roadways: Based on the Delta Angle
Exhibit 1240-2a	Traveled Way Width for Two-Lane One-Way Turning Roadways
Exhibit 1240-2b	Traveled Way Width for Two-Lane One-Way Turning Roadways: Based on the Delta Angle
Exhibit 1240-3a	Traveled Way Width for One-Lane Turning Roadways

Exhibit 1240-3b	Traveled Way Width for One-Lane Turning Roadways: Based on the Delta Angle, Radius on Outside Edge of Traveled Way
Exhibit 1240-3c	Traveled Way Width for One-Lane Turning Roadways: Based on the Delta Angle, Radius on Inside Edge of Traveled Way
Exhibit 1250-1	Minimum Radius for Normal Crown Section
Exhibit 1250-2	Minimum Radius for Existing Curves
Exhibit 1250-3	Side Friction Factor
Exhibit 1250-4a	Superelevation Rates (10% Max)
Exhibit 1250-4b	Superelevation Rates (8% Max)
Exhibit 1250-4c	Superelevation Rates (6% Max)
Exhibit 1250-5	Superelevation Rates for Intersections and Low-Speed Urban Roadways
Exhibit 1250-6a	Superelevation Transitions for Highway Curves
Exhibit 1250-6b	Superelevation Transitions for Highway Curves
Exhibit 1250-6c	Superelevation Transitions for Highway Curves
Exhibit 1250-6d	Superelevation Transitions for Highway Curves
Exhibit 1250-6e	Superelevation Transitions for Highway Curves
Exhibit 1250-7a	Superelevation Transitions for Ramp Curves
Exhibit 1250-7b	Superelevation Transitions for Ramp Curves
Exhibit 1260-1	Design Stopping Sight Distance
Exhibit 1260-2	Stopping Sight Distance: Design Criteria Selection
Exhibit 1260-3	Design Stopping Sight Distance on Grades
Exhibit 1260-4	Stopping Sight Distance on Grades
Exhibit 1260-5	Stopping Sight Distance: Crest Vertical Curves
Exhibit 1260-6	Sight Distance: Crest Vertical Curve
Exhibit 1260-7	Stopping Sight: Distance for Sag Vertical Curves
Exhibit 1260-8	Sight Distance: Sag Vertical Curve
Exhibit 1260-9	Sight Distance Area on Horizontal Curves
Exhibit 1260-10	Horizontal Stopping Sight Distance
Exhibit 1260-11	Sight Distance: Horizontal Curves
Exhibit 1260-12	Stopping Sight Distance: Overlapping Horizontal and Crest Vertical Curves
Exhibit 1260-13	Existing Stopping Sight Distance
Exhibit 1260-14	Passing Sight Distance
Exhibit 1260-15	Passing Sight Distance: Crest Vertical Curves
Exhibit 1260-16	Decision Sight Distance
Exhibit 1270-1	Climbing Lane Example
Exhibit 1270-2a	Speed Reduction Warrant: Performance for Trucks
Exhibit 1270-2b	Speed Reduction Warrant Example
Exhibit 1270-3	Auxiliary Climbing Lane
Exhibit 1270-4	Passing Lane Example

Exhibit 1270-5	Length of Passing Lanes
Exhibit 1270-6	Passing Lane Configurations
Exhibit 1270-7	Buffer Between Opposing Passing Lanes
Exhibit 1270-8	Auxiliary Passing Lane
Exhibit 1270-9	Slow-Moving Vehicle Turnout
Exhibit 1270-10	Emergency Escape Ramp Example
Exhibit 1270-11	Emergency Escape Ramp Length
Exhibit 1270-12	Rolling Resistance (R)
Exhibit 1270-13	Typical Emergency Escape Ramp
Exhibit 1270-14	Chain Up/Chain Off Area
Exhibit 1310-1	Intersection Area
Exhibit 1310-2a	Indirect Left Turns: Signalized Intersections
Exhibit 1310-2b	Indirect Left Turns: Unsignalized Intersections
Exhibit 1310-3	Split Tee Intersections
Exhibit 1310-4	Split Intersections
Exhibit 1310-5	Interchange Ramp Terminal Details
Exhibit 1310-6	Median at Two-Way Ramp Terminal
Exhibit 1310-7	Intersection Balance Example
Exhibit 1310-8	Roundabout at a Two-Way Ramp Terminal
Exhibit 1310-9	Diamond Interchange With Advance Storage
Exhibit 1310-10a	HOV Direct Access: Pavement Markings
Exhibit 1310-10b	HOV Direct Access: Signing
Exhibit 1310-11	Design Vehicle Types
Exhibit 1310-12	Minimum Intersection Design Vehicle
Exhibit 1310-13a	Turning Path Template
Exhibit 1310-13b	Turning Path Template
Exhibit 1310-13c	Turning Path Template
Exhibit 1310-14	Right-Turn Corner
Exhibit 1310-15a	Left-Turn Storage Guidelines: Two-Lane, Unsignalized
Exhibit 1310-15b	Left-Turn Storage Guidelines: Four-Lane, Unsignalized
Exhibit 1310-16a	Left-Turn Storage Length: Two-Lane, Unsignalized
Exhibit 1310-16b	Left-Turn Storage Length: Two-Lane, Unsignalized
Exhibit 1310-16c	Left-Turn Storage Length: Two-Lane, Unsignalized
Exhibit 1310-17	Left-Turn Storage With Trucks (ft)
Exhibit 1310-18a	Median Channelization: Widening
Exhibit 1310-18b	Median Channelization: Median Width 11 ft or More
Exhibit 1310-18c	Median Channelization: Median Width 23 ft to 26 ft
Exhibit 1310-18d	Median Channelization: Median Width of More Than 26 ft

Exhibit 1310-18e	Median Channelization: Minimum Protected Storage
Exhibit 1310-18f	Median Channelization: Two-Way Left-Turn Lane
Exhibit 1310-19	Right-Turn Lane Guidelines
Exhibit 1310-20	Right-Turn Pocket and Right-Turn Taper
Exhibit 1310-21	Right-Turn Lane
Exhibit 1310-22	Acceleration Lane
Exhibit 1310-23a	Traffic Island Designs
Exhibit 1310-23b	Traffic Island Designs: Compound Curve
Exhibit 1310-23c	Traffic Island Designs
Exhibit 1310-24	U-Turn Spacing
Exhibit 1310-25	U-Turn Roadway
Exhibit 1310-26	U-Turn Median Openings
Exhibit 1310-27a	Sight Distance at Intersections
Exhibit 1310-27b	Sight Distance at Intersections
Exhibit 1320-1	Roundabout Elements
Exhibit 1320-2	Entry Angle
Exhibit 1320-3	Turning Radius (R)
Exhibit 1320-4	Mini Roundabout
Exhibit 1320-5	Single-Lane Roundabout
Exhibit 1320-6a	Multilane Roundabout
Exhibit 1320-6b	Multilane Roundabout
Exhibit 1320-6c	Multilane Roundabout
Exhibit 1320-7a	Teardrop Roundabout at Ramp Terminals
Exhibit 1320-7b	Double Teardrop
Exhibit 1320-7c	Teardrop Roundabout With Ramps
Exhibit 1320-8	Initial Ranges
Exhibit 1320-9	Speed vs. Radius
Exhibit 1320-10	Approach Leg Alignment
Exhibit 1320-11	Circulating Roadway Slope
Exhibit 1320-12	Speed vs. Intersection Sight Distance
Exhibit 1320-13a	Design Iteration Steps
Exhibit 1320-13b	Design Iteration Steps
Exhibit 1320-14a	Truck Turning Paths
Exhibit 1320-14b	Truck Turning Paths
Exhibit 1320-15a	Fastest Path Radii
Exhibit 1320-15b	Fastest Path Radii
Exhibit 1320-15c	Fastest Path Radii
Exhibit 1320-16	Consecutive Radii
Exhibit 1320-17	Coinciding Radii and Conflict Points

Exhibit 1320-18	Entry Design Path
Exhibit 1320-19	Entry and Exit Curves
Exhibit 1320-20	Central Island and Cross Section
Exhibit 1320-21	Approach Stopping Sight Distance to Crosswalk
Exhibit 1320-22	Stopping Sight Distance on Circulatory Roadway
Exhibit 1320-23	Exit Stopping Sight Distance to Crosswalk
Exhibit 1320-24	Intersection Sight Distance
Exhibit 1320-25	Landscaping Height Restrictions for Intersection Sight Distance
Exhibit 1320-26	Right-Turn Slip Lane Termination
Exhibit 1320-27	Add and Drop Lanes
Exhibit 1320-28	Railroad Gate Configuration
Exhibit 1320-29	Bicycle Lanes
Exhibit 1320-30	Roundabout Signing
Exhibit 1320-31	Roundabout Striping and Pavement Marking
Exhibit 1320-32	Roundabout Illumination
Exhibit 1320-33a	Multiple Access Circulation
Exhibit 1320-33b	Multiple Access Circulation
Exhibit 1330-1	Responsibility for Facilities
Exhibit 1330-2	Standard Intersection Movements and Head Numbers
Exhibit 1330-3	Phase Diagrams: Four-Way Intersections
Exhibit 1330-4	Left-Turn Lane Configuration Examples
Exhibit 1330-5	Example of Closed Pedestrian Crossings
Exhibit 1330-6a	Vacant
Exhibit 1330-6b	Vacant
Exhibit 1330-7	Decision Zone Loop Placement
Exhibit 1330-8	Loop Numbering Layout
Exhibit 1330-9	Signal Display Maximum Heights
Exhibit 1330-10	Signal Display Areas
Exhibit 1330-11a	Strain Pole and Foundation Selection Procedure
Exhibit 1330-11b	Strain Pole and Foundation Selection Procedure
Exhibit 1330-12	Strain Pole and Foundation Selection Example
Exhibit 1330-13	Conduit and Conductor Sizes
Exhibit 1330-14a	Traffic Signal Display Placements
Exhibit 1330-14b	Traffic Signal Display Placements
Exhibit 1330-14c	Traffic Signal Display Placements
Exhibit 1330-14d	Traffic Signal Display Placements
Exhibit 1330-14e	Traffic Signal Display Placements
Exhibit 1330-14f	Traffic Signal Display Placements
Exhibit 1340-1	Road Approach Design Templates

Exhibit 1340-2	Road Approach Access Category
Exhibit 1340-3	Road Approach Design Template A1
Exhibit 1340-4	Road Approach Design Templates B1 and C1
Exhibit 1340-5	Road Approach Design Template D1
Exhibit 1340-6	Road Approach Sight Distance
Exhibit 1350-1	Sight Distance at Railroad Crossing
Exhibit 1350-2	Typical Pullout Lane at Railroad Crossing
Exhibit 1360-1	Basic Interchange Patterns
Exhibit 1360-2	Interchange Spacing
Exhibit 1360-3	Minimum Ramp Connection Spacing
Exhibit 1360-4	Ramp Design Speed
Exhibit 1360-5	Maximum Ramp Grade
Exhibit 1360-6	Ramp Widths
Exhibit 1360-7a	Lane Balance
Exhibit 1360-7b	Lane Balance
Exhibit 1360-8	Main Line Lane Reduction Alternatives
Exhibit 1360-9	Acceleration Lane Length
Exhibit 1360-10	Deceleration Lane Length
Exhibit 1360-11a	Gore Area Characteristics
Exhibit 1360-11b	Gore Area Characteristics
Exhibit 1360-12	Length of Weaving Sections
Exhibit 1360-13a	On-Connection: Single-Lane, Tapered
Exhibit 1360-13b	On-Connection: Single-Lane, Parallel
Exhibit 1360-13c	On-Connection: Two-Lane, Parallel
Exhibit 1360-13d	On-Connection: Two-Lane, Tapered
Exhibit 1360-14a	Off-Connection: Single-Lane, Tapered
Exhibit 1360-14b	Off-Connection: Single-Lane, Parallel
Exhibit 1360-14c	Off-Connection: Single-Lane, One-Lane Reduction
Exhibit 1360-14d	Off-Connection: Two-Lane, Tapered
Exhibit 1360-14e	Off-Connection: Two-Lane, Parallel
Exhibit 1360-15a	Collector-Distributor: Outer Separations
Exhibit 1360-15b	Collector Distributor: Off-Connections
Exhibit 1360-15c	Collector Distributor: On-Connections
Exhibit 1360-16	Loop Ramp Connections
Exhibit 1360-17	Temporary Ramps
Exhibit 1360-18	Interchange Plan
Exhibit 1410-1	Minimum Traveled Way Widths for Articulated Buses
Exhibit 1410-2	Typical HOV Lane Sections
Exhibit 1410-3	Roadway Widths for Two-Lane Ramps With an HOV Lane

Exhibit 1410-4a	Single-Lane Ramp Meter With HOV Bypass
Exhibit 1410-4b	Two-Lane Ramp Meter With HOV Bypass
Exhibit 1410-5a	Enforcement Area: One Direction Only
Exhibit 1410-5b	Enforcement Area: Median
Exhibit 1420-1	Minimum Ramp Widths for Articulated Buses
Exhibit 1420-2	Gap Acceptance Length for Parallel On-Connections
Exhibit 1420-3	Drop Ramp
Exhibit 1420-4	T Ramp
Exhibit 1420-5	Flyover Ramp
Exhibit 1420-6	Side Platform Flyer Stop
Exhibit 1420-7	At-Grade Crossing Flyer Stop
Exhibit 1420-8	Transit Stops at Ramps
Exhibit 1420-9	Other Transit Stops
Exhibit 1420-10	Single-Lane Parallel On-Connection
Exhibit 1420-11	HOV Direct Access Acceleration Lane Length
Exhibit 1420-12	Single-Lane Parallel Off-Connection
Exhibit 1420-13	Drop Ramp Gore Area Characteristics
Exhibit 1420-14	Deceleration Lane Length for Buses
Exhibit 1420-15	T Ramp Design
Exhibit 1420-16	Flyer Stop Signing
Exhibit 1420-17	HOV Direct Access Signing: Main Line
Exhibit 1420-18	HOV Direct Access Signing: Local Street and Ramp Terminal
Exhibit 1420-19	HOV Direct Access Overhead Signs
Exhibit 1420-20	HOV Direct Access Shoulder-Mounted Signs
Exhibit 1430-1	Bus Berth Designs
Exhibit 1430-2	Transit Center Sawtooth Bus Berth
Exhibit 1430-3	Bus Turnout Transfer Center
Exhibit 1430-4	Off-Street Transfer Center
Exhibit 1430-5	Minimum Bus Zone Dimensions
Exhibit 1430-6	Bus Stop Pullouts: Arterial Streets
Exhibit 1430-7	Minimum Bus Zone and Pullout After Right-Turn Dimensions
Exhibit 1430-8	Shelter Siting
Exhibit 1430-9	Typical Bus Shelter Design
Exhibit 1430-10	Turning Template for a 40-Foot Bus
Exhibit 1430-11	Turning Template for an Articulated Bus
Exhibit 1430-12	Intersection Design
Exhibit 1430-13	Cross-Street Width Occupied by Turning Vehicle for Various Angles of Intersection and Curb Radii
Exhibit 1430-14	Passenger Loading Pad

Exhibit 1510-1	Pedestrian Circulation Paths
Exhibit 1510-2	Relationship Between Pedestrian Circulation Paths and Pedestrian Access Routes
Exhibit 1510-3	Obstructed Pedestrian Access Route
Exhibit 1510-4	Surface Discontinuities (Noncompliant)
Exhibit 1510-5	Sidewalks With Buffers
Exhibit 1510-6	Typical Sidewalk Designs
Exhibit 1510-7	Typical Driveways
Exhibit 1510-8	Perpendicular Curb Ramp
Exhibit 1510-9	Perpendicular Curb Ramp Common Elements
Exhibit 1510-10	Parallel Curb Ramp
Exhibit 1510-11	Parallel Curb Ramp Common Elements
Exhibit 1510-12	Combination Curb Ramp
Exhibit 1510-13	Typical Curb Ramp Drainage
Exhibit 1510-14	Unmarked Crosswalks
Exhibit 1510-15	Marked Pedestrian Crossing
Exhibit 1510-16	Example of Closed Pedestrian Crossing
Exhibit 1510-17	Midblock Pedestrian Crossing
Exhibit 1510-18	Obstructed Line of Sight at Intersection
Exhibit 1510-19	Improved Line of Sight at Intersection
Exhibit 1510-20	Curb Extension Examples
Exhibit 1510-21	Raised Islands With Curb Ramps and Pedestrian Cut-Throughs
Exhibit 1510-22	Pedestrian Railroad Crossings
Exhibit 1510-23	Pedestrian Railroad Warning Device
Exhibit 1510-24	Pedestrian Bridges
Exhibit 1510-25	Pedestrian Tunnel
Exhibit 1510-26	Access Ramp With Accessible Handrails
Exhibit 1510-27	Work Zones and Pedestrian Facilities
Exhibit 1510-28	Crosswalk Marking and Enhancement Guidelines
Exhibit 1515-1	Shared-Use Path
Exhibit 1515-2	Bicycle Design Speeds
Exhibit 1515-3	Two-Way Shared-Use Path: Independent Alignment
Exhibit 1515-4	Two-Way Shared-Use Path: Adjacent to Roadway
Exhibit 1515-5	Shared-Use Path Landings Profile
Exhibit 1515-6	Shared-Use Path Landing and Rest Area
Exhibit 1515-7	Shared-Use Path Curve Widening
Exhibit 1515-8	Typical Redesign of a Diagonal Midblock Crossing
Exhibit 1515-9	Adjacent Shared-Use Path Intersection
Exhibit 1515-10	Refuge Area
Exhibit 1515-11	Barrier Adjacent to Shared-Use Path

Exhibit 1515-12	Stopping Sight Distance
Exhibit 1515-13	Sight Distances for Vertical Curves
Exhibit 1515-14	Lateral Clearance on Horizontal Curves
Exhibit 1520-1	Bike Facility Selection
Exhibit 1520-2	Shared Roadway
Exhibit 1520-3	Signed Shared Roadway: Designated Bike Route
Exhibit 1520-4	Bike Lane
Exhibit 1520-5	Typical Urban Bike Lane Cross Sections
Exhibit 1520-6	Typical Bicycle/Auto Movements at Intersection of Multilane Streets
Exhibit 1520-7	Bike Lanes Approaching Motorists' Right-Turn-Only Lanes
Exhibit 1520-8a	Bicycle Crossing of Interchange Ramp
Exhibit 1520-8b	Bicycle Crossing of Interchange Ramp
Exhibit 1520-9	At-Grade Railroad Crossings
Exhibit 1520-10	Barrier Adjacent to Bicycle Facilities
Exhibit 1600-1	Design Clear Zone Distance Table
Exhibit 1600-2	Design Clear Zone Inventory Form (# 410-026 EF)
Exhibit 1600-3	Recovery Area
Exhibit 1600-4	Design Clear Zone for Ditch Sections
Exhibit 1600-5	Guidelines for Embankment Barrier
Exhibit 1600-6	Mailbox Location and Turnout Design
Exhibit 1600-7	Glare Screens
Exhibit 1610-1	Type 7 Bridge Rail Upgrade Criteria
Exhibit 1610-2	Longitudinal Barrier Deflection
Exhibit 1610-3	Longitudinal Barrier Flare Rates
Exhibit 1610-4	Traffic Barrier Locations on Slopes
Exhibit 1610-5	Old Type 3 Anchor
Exhibit 1610-6	Guardrail Connections
Exhibit 1610-7	Concrete Barrier Shapes
Exhibit 1610-8	Concrete Barrier Placement Guidance: Assessing Impacts to Wildlife
Exhibit 1610-9	Transitions and Connections
Exhibit 1610-10a	Barrier Length of Need on Tangent Sections
Exhibit 1610-10b	Barrier Length of Need
Exhibit 1610-10c	Barrier Length of Need on Curves
Exhibit 1610-10d	W-Beam Guardrail Trailing End Placement for Divided Highways
Exhibit 1610-11	Beam Guardrail Post Installation
Exhibit 1610-12a	Beam Guardrail Terminals
Exhibit 1610-12b	Beam Guardrail Terminals
Exhibit 1610-13a	Cable Barrier Locations on Median Slopes
Exhibit 1610-13b	Cable Barrier Locations on Shoulder Slopes

Exhibit 1610-13c	Cable Barrier Placement for Divided Highways
Exhibit 1610-14	Thrie Beam Rail Retrofit Criteria
Exhibit 1620-1	Impact Attenuator Sizes
Exhibit 1620-2a	Impact Attenuator Systems: Permanent Installations
Exhibit 1620-2b	Impact Attenuator Systems: Permanent Installations
Exhibit 1620-2c	Impact Attenuator Systems: Permanent Installations
Exhibit 1620-2d	Impact Attenuator Systems: Permanent Installations
Exhibit 1620-2e	Impact Attenuator Systems: Permanent Installations
Exhibit 1620-3a	Impact Attenuator Systems: Work Zone Installations
Exhibit 1620-3b	Impact Attenuator Systems: Work Zone Installations
Exhibit 1620-4a	Impact Attenuator Systems: Older Systems
Exhibit 1620-4b	Impact Attenuator Systems: Older Systems
Exhibit 1620-5	Impact Attenuator System Comparison
Exhibit 1620-6	Impact Attenuator Distance Beyond Length of Need
Exhibit 1710-1	Typical Truck Storage
Exhibit 1710-2	Typical Single RV Dump Station Layout
Exhibit 1710-3	Typical Two RV Dump Station Layout
Exhibit 1720-1	Truck Weigh Site: Multilane Highways
Exhibit 1720-2	Truck Weigh Site: Two-Lane Highways
Exhibit 1720-3	Vehicle Inspection Installation
Exhibit 1720-4	Minor Portable Scale Site
Exhibit 1720-5	Major Portable Scale Site
Exhibit 1720-6	Small Shoulder Site
Exhibit 1720-7	Large Shoulder Site
Exhibit 1720-8	MOU Related to Vehicle Weighing and Equipment: Inspection Facilities on State Highways

100.05 Manual Organization

The *Design Manual* is split into the following two volumes:

- Volume 1 contains *procedural topics*, including project documentation, permitting and hearings, site data, project investigation, and guidance for coordination with specialty group functions such as traffic, right of way, bridge and structures, and geotechnical design.
- Volume 2 addresses *design criteria and geometrics*. The design matrices are included in this volume because they communicate expectations for which elements are included in projects.

Each volume is divided into a series of divisions that address a portion of the project development and design processes. The divisions are comprised of chapters that address the general topic in detail and are, in some cases, specific to a particular discipline. Both volumes contain a complete Contents section and a complete Index.

(1) Volume 1: Procedures

Division 1 – General Information: Presents general background on planning, managing project delivery, project development, and programming.

- **Chapter 100 – Manual Description:** Chapter content and resources within the *Design Manual*.
- **Chapter 110 – Design-Build Projects:** How the *Design Manual* applies to design-build projects: includes terminology and reference to design-build contract documents.
- **Chapter 120 – Planning:** Critical information, such as corridor studies and route development plans, relating to the corridor in which the project resides.
- **Chapter 130 – Project Development Sequence:** The project development sequence from the Washington Transportation Plan through the contract document: emphasizes the Project Summary and Change Management process.

Division 2 – Hearings, Environmental, and Permits: Provides the designer with information about the public involvement and hearings process, the environmental documentation process, and the permit process.

- **Chapter 210 – Public Involvement and Hearings:** Developing a project-specific public involvement plan; the ingredients of an effective public involvement plan; and methods for public involvement.
- **Chapter 220 – Project Environmental Documentation:** An elementary background on the environmental documentation process and its requirements.
- **Chapter 230 – Environmental Permits and Approvals:** Permits that may be required for highway and bridge projects.

Division 3 – Project Documentation: Provides designers with information on value engineering, traffic analysis, design documentation, and approvals.

- **Chapter 300 – Design Documentation, Approval, and Process Review:** Building the Project File (PF) and the Design Documentation Package (DDP) and recording the recommendations and decisions that lead to a project by preserving the documents from the planning, scoping, programming, and design phases (includes permits, approvals, contracts, utility relocation, right of way, advertisement and award, and construction).
- **Chapter 305 – Managing Projects:** Brief description and links to WSDOT design and project development resources.
- **Chapter 310 – Value Engineering:** A systematic, multidisciplinary process study early in the project design stage to provide recommendations to improve scope, functional design, constructibility, environmental impacts, or project cost—required by federal law for high-cost, complex projects.
- **Chapter 320 – Traffic Analysis:** Procedural guidance and general requirements for conducting traffic analyses.

Division 4 – Surveying: Includes criteria for surveying, mapping, and monumentation requirements.

- **Chapter 400 – Surveying and Mapping:** The procedures within WSDOT for project surveying.
- **Chapter 410 – Monumentation:** The requirements and procedures for Monumentation.

Division 5 – Right of Way and Access Control: Provides guidance on right of way considerations; interchange justification reports; limited/managed access; and fencing.

- **Chapter 510 – Right of Way Considerations:** The right of way and easement acquisition process.
- **Chapter 520 – Access Control:** WSDOT Access Control program information.
- **Chapter 530 – Limited Access Control:** Clarification on full, partial, and modified limited access control.
- **Chapter 540 – Managed Access Control:** The classes of managed access highways and the access connection permitting process.
- **Chapter 550 – Interchange Justification Report:** The process for access point revisions on limited access controlled highways and the steps for producing an interchange justification report.
- **Chapter 560 – Fencing:** The purpose of fencing, types of fencing, and fencing design criteria.

Division 6 – Soils and Paving: Presents guidance for investigating soils, rock, and surfacing materials; estimating tables; and guidance and criteria for the use of geosynthetics.

- **Chapter 610 – Investigation of Soils, Rock, and Surfacing Materials:** The requirements for qualifying a materials source, geotechnical investigations, and the documentation to be included in the Project File.
- **Chapter 620 – Design of Pavement Structures:** Estimating tables for the design of pavement structures.
- **Chapter 630 – Geosynthetics:** The types/applications of geosynthetic drainage, earthwork, erosion control, and soil reinforcement materials.

Metropolitan Planning Organization (MPO) A lead agency designated by the Governor to administer the federally required transportation planning process in a metropolitan area with a population over 50,000. The MPO is responsible for the 20-year long-range plan and Transportation Improvement Program (TIP).

National Highway System (NHS) A network of roadways designated by Congress that consists of all interstate routes; a large percentage of urban and rural principal arterials; and strategic highways and highway connectors.

planning Transportation planning is a decision-making process required by federal and state law used to solve complex, interrelated transportation and land use problems (see Chapter 120).

Plans, Specifications, and Estimates (PS&E) The project development activity that follows Project Definition and culminates in the completion of contract-ready documents and the engineer's cost estimate.

preliminary engineering (PE) A term used to describe the Project Delivery process from project scoping through PS&E review.

priority array A collection of similar needs identified in the HSP, prioritized based on the methodology adopted by WSDOT to meet the requirements of RCW 47.05.

Priority Array Tracking System (PATs) A database that allows tracking of highway needs and their solutions. The system is designed to ensure WSDOT addresses the highest-ranked transportation needs. Deficiencies are tracked for each strategy in the HSP.

Project Control and Reporting (PC&R) The Headquarters (HQ) Project Control and Reporting Office is responsible for monitoring, tracking, and reporting delivery of the Highway Construction Program in coordination with the Program Management offices in each of the six WSDOT regions and the Urban Corridors Office.

Project Summary A document that comprises the Project Definition, Design Decisions Summary, and Environmental Review Summary. The Project Summary ensures the project scope addresses the need identified in the HSP, the design complies with design guidelines, and potential environmental impacts and required permits are understood. The Project Summary is prepared by the region and reviewed and approved by Headquarters prior to budget submittal.

Regional Transportation Planning Organization (RTPO) A planning organization authorized by the Legislature in 1990 as part of the Growth Management Act. The RTPO is a voluntary organization with representatives from state and local governments that are responsible for coordinating transportation planning activities within a region.

Project Scoping See Chapter 300.

Statewide Transportation Improvement Program (STIP) A planning document that includes all federally funded projects and other regionally significant projects for a three-year period.

Surface Transportation Program (STP) A federal program established by Congress in 1991 that provides a source of federal funding for highway and bridge projects.

Transportation Improvement Program (TIP) A three-year transportation improvement strategy required from MPOs by Congress, which includes all federally funded or regionally significant projects.

Transportation Information and Planning Support (TRIPS) A mainframe computer system designed to provide engineering, maintenance, planning, and accounting staff with highway inventory, traffic, and accident data.

Transportation Planning Studies These studies identify the current functions of a corridor and forecast future demands on the system. Data collection and public involvement are used to forecast future needs that will improve the function of a state route.

Washington State Pavement Management System (WSPMS) A computer system that stores data about the pavement condition of all the highways in the state. Information available includes the latest field review and past contracts for every main line mile of state highway. Calculations are used to determine whether a given section of pavement is a *past due*, *due*, or *future due* preservation need.

Washington Transportation Plan (WTP) A WSDOT planning document developed in coordination with local governments, regional agencies, and private transportation providers. The WTP addresses the future of transportation facilities owned and operated by the state as well as those the state does not own but in which it has an interest. It identifies needed transportation investments, which are defined by service objectives and specific desired outcomes for each transportation mode.

130.04 Project Development Sequence

The *Design Manual* addresses the project development process beginning with scoping, through programming with the Legislature, to project development approval.

Project development is a multidisciplinary effort that evaluates a variety of solutions for project needs. The following information pertains to the needs identified in the Highway System Plan, which suggests a list of proposed solutions based on an incremental approach. This process bridges the gap from need identification to project construction. Project Definition documents provide the framework for further development of the project scope, schedule, and estimate, and they record key decisions made early in the project development process. The contract documents provide sufficient detail to enable contractors to construct the project. Final project design decisions are documented and stored in the Design Documentation Package (DDP).

Integrating planning, program development, and project delivery are important elements for the efficient and successful delivery of the transportation projects in the Capital Improvement and Preservation Program (CIPP) approved by the Legislature. The program development process needs a global understanding in order to eliminate later corrective modifications or rework. Project modifications and rework are costly, and they impact delivery commitments made to the Legislature and the public. These projects are developed such that information and processes flow seamlessly between the planning and implementation phases of a project.

(e) Categories of Work

The HSP presents the budgets for the Maintenance (M), Operations (Q), Preservation (P), and Improvement (I) programs. Strategies and conceptual solutions are limited to the Preservation and Improvement programs. Each of these programs is divided into subprograms, as shown in the Exhibits 130-1 and 130-2.

(3) Project Summary

The Project Summary is developed in the region when a project is proposed for programming. The intent of the Project Summary is to initiate the development of a project by identifying the need that generated the project and the proposed solution to solve that need.

The regions prepare the Project Summary during project scoping. The information provided guides the project through the design process to project approval.

The Project Summary:

- Defines the purpose and need for the project and spells out the scope of work.
- Includes a cost/benefit measure to determine the project's cost-effectiveness.
- Documents the design decisions or assumptions that the region made while determining the project scope.
- Identifies the major factors that will influence the scope, schedule, and budget and includes a cost increase factor for unidentified risks.
- Establishes initial preliminary engineering, right of way, and construction cost estimates.
- Documents the project delivery schedule.
- Requires approval by the HQ SA&PD Section prior to submittal to the Legislature for programming consideration.
- Documents the potential environmental impacts and permits that may be required.

Regions are encouraged to place special emphasis on project scoping, estimating, and scheduling during program development as a means to verify that program delivery stays within the appropriated dollars and workforce. Resources available to the regions include: Highway System Plan; route development plans, and other approved corridor studies; Design Matrices; *Roadside Classification Plan*; Environmental Workbench and other planning; and design and environmental documents to ensure project scoping is consistent.

The initial environmental classification and documentation required for the project is established in the Environmental Review Summary (ERS) section of the Project Summary. Environmental classification at the Project Summary stage has several benefits. It helps clarify the impacts associated with a project and also helps to establish a realistic schedule and PE cost estimate. All projects require supporting State Environmental Policy Act (SEPA) documentation. For projects eligible for federal funding, National Environmental Policy Act (NEPA) documentation is also required.

When scoping projects, regions are encouraged to take full advantage of expertise available from the HQ Systems Analysis and Program Development (SA&PD) Section of the Strategic Planning and Programming Division, FHWA, the HQ Environmental Services Office, and local agencies. These resources can help the regions evaluate a project's impacts and provide the appropriate project direction. They will also help ensure all aspects are considered and the proposed solution is eligible for available funding.

The HQ SA&PD Section coordinates review of the Project Summary and forwards any comments to the regions for resolution prior to approval. Once all comments and outstanding issues are resolved, the Project Summary can be approved and copies distributed.

(4) Environmental Document

The environmental document is a statement that identifies impacts to the natural and constructed environment as a result of a project and its potential mitigation. The statement may consist of one or two pages for categorically exempted projects, a SEPA Checklist, Documented Categorical Exclusion (DCE), or an Environmental Assessment (EA) or Environmental Impact Statement (EIS) for major projects (see Chapter 220).

(5) Design Documentation Package (DDP)

The DDP, which is a portion of the Project File, is a formal document of design decisions and conclusions reached in the development of a project. The Project File records various design recommendations that are reviewed within the department and, when approved, become the project design (see Chapter 300).

(6) Right of Way/Limited Access Plans

Right of way/limited access plans are the official state documents used to acquire real estate, property, and access rights. These plans determine rights of access from abutting property owners, interchange/intersection spacing, access points per mile, or other selective approaches to a highway facility. Right of way plans are used to obtain the "Order of Public Use and Necessity," which is the authority to acquire real property and property rights under eminent domain.

The establishment of limited access control is considered whenever major improvements, reconstruction, relocation, significant new rights of way, or new facilities are required. (See Chapters 520, 530, and 540, and the *Plans Preparation Manual* for more information.)

(7) Contract Documents

The contract Plans, Specifications, and Estimates (PS&E) are the final documents needed for the advertisement of a construction contract. Contract plans conform to the basic design features approved in the Project Summary, environmental documents, and Design Documentation Package. Present the work in the plans and contract specifications in a clear and concise manner to avoid misinterpretation. A tool available to the designer to check whether required items are addressed during the PS&E preparation is the "PS&E Review Checklist," available at: www.wsdot.wa.gov/Design/ProjectDev/. Projects may go through PS&E preparation, but they will not be advertised for construction until the required work and approvals are complete (see the *Plans Preparation Manual*).

300.01	General
300.02	References
300.03	Definitions
300.04	Design Documentation
300.05	Project Development
300.06	FHWA Approval
300.07	Design Approval
300.08	Project Development Approval
300.09	Process Review

300.01 General

The Project File (PF) contains the documentation for planning, scoping, programming, design, approvals, contract assembly, utility relocation, needed right of way, advertisement, award, construction, and maintenance review comments for a project. A Project File is completed for all projects and is retained by the region office responsible for the project. Responsibility for the project may pass from one office to another during the life of a project, and the Project File follows the project as it moves from office to office.

The Design Documentation Package (DDP) is a part of the Project File. It documents and explains design decisions and the design process that was followed. The DDP is retained in a permanent retrievable file for a period of 75 years, in accordance with the Washington State Department of Transportation (WSDOT) records retention policy.

With the exception of the DDP, the Project File may be purged when retention of the construction records is no longer necessary.

For operational changes and local agency and developer projects, design documentation is also needed. It is retained by the region office responsible for the project, in accordance with WSDOT records retention policy. All participants in the design process are to provide the appropriate documentation for their decisions.

For emergency projects, also refer to the *Emergency Relief Procedures Manual*. It provides the legal and procedural guidelines for WSDOT employees to prepare all necessary documentation to respond to, and recover from, emergencies and disasters that affect the operations of the department.

300.02 References

(1) *Federal/State Laws and Codes*

23 Code of Federal Regulations (CFR) 635.111, Tied bids

23 CFR 635.411, Material or product selection

Revised Code of Washington (RCW) 47.28.030, Contracts – State forces – Monetary limits – Small businesses, minority, and women contractors – Rules

RCW 47.28.035, Cost of project, defined

“Washington Federal-Aid Stewardship Agreement,” as implemented in the design matrices (see Chapter 1100)

(2) Design Guidance

WSDOT Directional Documents Index, including the one listed below:

☞ <http://wwwi.wsdot.wa.gov/publications/policies>

- Executive Order E 1010, “Certification of Documents by Licensed Professionals,” WSDOT

WSDOT technical manuals, including those listed below:

☞ www.wsdot.wa.gov/publications/manuals/index.htm

- *Advertisement and Award Manual*, M 27-02, WSDOT
- *Emergency Relief Procedures Manual*, M 3014, WSDOT
- *Environmental Procedures Manual*, M 31-11, WSDOT
- *Hydraulics Manual*, M 23-03, WSDOT
- *Plans Preparation Manual*, M 22-31, WSDOT
- *Project Control and Reporting Manual*, M 3026, WSDOT
- *Roadside Classification Plan*, M 25-31, WSDOT

Limited Access and Managed Access Master Plan, WSDOT

☞ www.wsdot.wa.gov/design/accessandhearings/tracking.htm

Washington State Highway System Plan, WSDOT

☞ www.wsdot.wa.gov/planning/

(3) Supporting Information

A Policy on Geometric Design of Highways and Streets (Green Book), AASHTO, 2004

300.03 Definitions

consider To think carefully about, especially in order to make a decision. No backup documentation is required.

corridor analysis Documentation that justifies a change in design level and/or decisions to include, exclude, or modify design elements. A corridor analysis addresses needs and design solutions within a substantial segment of roadway. A corridor analysis is useful beyond a specific project contained within it, and it is an appropriate document to address design speed.

Design Approval Documented approval of the design criteria, which becomes part of the Design Documentation Package. This approval is an endorsement of the design criteria by the designated representative of the approving organization as shown in Exhibit 300-2.

design exception (DE) A method to document a geometric feature that has been preauthorized to exclude improvement of an existing design element for various types of projects, as designated in the design matrices (see Chapter 1100). A DE designation

indicates that the design element is normally outside the scope of the project type (see Exhibit 300-1). Some design exceptions require justification.

design variance A recorded decision to differ from the design level specified in the *Design Manual*, such as an evaluate upgrade (EU) not upgraded, a DE, or a deviation. EUs leading to an upgrade are documented but are not considered to be variances. A project or corridor analysis may also constitute a design variance if that analysis leads to a decision to use a design level or design classification that differs from what the *Design Manual* specifies for the project type.

Design Variance Inventory (DVI) A list of design elements that will not be improved in accordance with the *Design Manual* criteria designated for the project. Only approved variances should be included on this list.

Design Variance Inventory System (DVIS) A database application developed to generate the DVI form. The DVIS also provides query functions, giving designers an opportunity to search for previously granted variances. The DVIS was started in the early 2000s and does not identify prior variances. The *Design Manual* is constantly being refined and guidelines change over time. What may have been a design variance previously may not be a deviation today. Previously approved design variances do not carry forward and must be revisited as described in 300.04(5). The DVIS database is intended for internal WSDOT use only, and WSDOT staff access it from the left margin of this website: <http://wwwi.wsdot.wa.gov/design/>

desirable Design criteria that are recommended for inclusion in the design. Document conditions when a desirable value is not met.

deviation A documented decision granting approval at project-specific locations to differ from the design level specified in the *Design Manual* (see Chapter 1100 and Exhibit 300-1).

document (verb) The act of including a short note to the Design Documentation Package that explains a design decision.

environmental acronyms (see Chapter 220 for definitions)

- **NEPA** National Environmental Policy Act
- **SEPA** [Washington] State Environmental Policy Act
- **CE** NEPA: Categorical Exclusion
- **DCE** NEPA: Documented Categorical Exclusion
- **CE** SEPA: Categorical Exemption
- **EA** NEPA: Environmental Assessment
- **ECS** Environmental Classification Summary
- **EIS** Environmental Impact Statement
- **ERS** Environmental Review Summary
- **FONSI** NEPA: Finding Of No Significant Impact
- **ROD** NEPA: Record of Decision

evaluate upgrade (EU) A decision-making process to determine whether or not to upgrade an existing design element as designated in the design matrices. Documentation is required (see Exhibit 300-1).

FHWA Federal Highway Administration.

HQ Washington State Department of Transportation Headquarters organization.

justify Preparing a memo to the DDP identifying the reasons for the decision: a comparison of advantages and disadvantages of all options considered. A more rigorous effort than *document*.

minimum The lowest design value allowed without a deviation.

maximum The highest design value allowed without a deviation.

Project Analysis Documentation that justifies a change in design level and/or decisions to include, exclude, or modify design elements specific to a project only (also see Chapter 1100).

Project Change Request Form A form used to document and approve revisions to project scope, schedule, or budget from a previously approved Project Definition (see *Project Summary*). Include copies in the Design Documentation Package.

Project Development Approval Final approval of all project development documents by the designated representative of the approving organization prior to the advertisement of a capital transportation project (see Exhibit 300-2).

Project File (PF) A file containing all documentation and data for all activities related to a project (see 300.01 and 300.04).

- **Design Documentation Package (DDP)** The portion of the Project File, including Design Approval and Project Development Approval, that will be retained long term in accordance with WSDOT document retention policies. Depending on the scope of the project, it contains the Project Summary and some or all of the other documents discussed in this chapter. Common components are listed in Exhibit 300-5. Technical reports and calculations are part of the Project File, but they are not designated as components of the DDP. Include estimates and justifications for decisions made in the DDP (see 300.04(2)). The DDP explains how and why the design was chosen and documents approvals (see 300.01).

Project Summary A set of electronic documents consisting of the Design Decisions (DD), Environmental Review Summary (ERS), and Project Definition (PD). The Project Summary is part of the design documentation required to obtain Design Approval and is ultimately part of the design documentation required for Project Development Approval (see 300.06).

- **Design Decisions (DD)** An electronic document that records major design decisions regarding roadway geometrics, roadway and roadside features, and other issues that influence the project scope and budget.
- **Environmental Review Summary (ERS)** An electronic document that records the environmental classification (class of action) and considerations (consequences of action) for a specific project.
- **Project Definition (PD)** An electronic document that records the purpose and need of the project, along with program level and design constraints.

scoping phase The first phase of project development for a specific project, the scoping phase follows identification of the need for a project and precedes detailed project design. It is the process of identifying the work to be done and developing a cost estimate for completing the design and construction. The Project Summary, engineering and construction estimates, and possibly several technical reports (geotechnical, surfacing, bridge condition, and so on) are developed during this phase.

300.04 Design Documentation

(1) Purpose

Design documentation records the evaluations and decisions by the various disciplines that result in design recommendations. Design assumptions and decisions made prior to and during the scoping phase are included. Changes that occur throughout project development are documented. Required justifications and approvals are also included.

The “Design Documentation Checklist” has been developed as a tool (optional) to assist in generating the contents of the DDP and the PF: www.wsdot.wa.gov/design/projectdev/

(2) Design Documents

The DDP portion of the PF preserves the decision documents generated during the design process. In each package, a summary (list) of the documents included is recommended.

The design documents commonly included in the PF and DDP for all but the simplest projects are listed in Exhibit 300-5.

Documentation is not required for components not related to the project as dictated by the design matrices.

A DVI is needed for all projects that have design variances. The DVI lists all EUs not upgraded to the applicable design level, DEs, and deviations as indicated by the design matrices. Record variances that result from a project or corridor analysis in the DVI. Use the DVIS database to record and manage:

- Individual design variances identified during project development.
- Variances resulting from a project or corridor analysis.

The DVIS database can be accessed from this website: <http://www.wsdot.wa.gov/design/>

The ERS and the PD are required for most projects. Exceptions will be identified by the HQ Project Control and Reporting Office.

The DD is not required for the following project types unless they involve reconstructing the lanes, shoulders, or fill slopes. Since these and some other project types are not included in the design matrices, evaluate them with respect to modified design level (M) for non-NHS routes and full design level (F) for NHS routes. Include in the evaluation only those design elements specifically impacted by the project. Although the following list illustrates some of the project types that do not require a DD, the list is not intended to be a complete accounting of all such projects. A project-specific matrix can be generated for a project. Consult with the appropriate ASDE for projects not included on the list.

- Bridge painting
- Crushing and stockpiling
- Pit site reclamation
- Lane marker replacement
- Guidepost replacement
- Signal rephasing
- Signal upgrade
- Seismic retrofit
- Bridge joint repair
- Navigation light replacement
- Signing upgrade
- Illumination upgrade
- Intelligent Transportation System (ITS) upgrade
- Rumble strips
- Electrical upgrades
- Major drainage
- Bridge scour
- Fish passage
- Other projects approved by the HQ Design Office

(3) Certification of Documents by Licensed Professionals

All original technical documents must bear the certification of the responsible licensee (see Executive Order E 1010).

(4) Design Exception (DE), Evaluate Upgrade (EU), and Deviation Documentation

In special cases, projects may need to address design elements, which are shown as blank cells in a design matrix (see Exhibit 300-1). These special cases must be coordinated with the appropriate Assistant State Design Engineer (ASDE) and the HQ Project Control and Reporting Office. When this is necessary, document the reasons for inclusion of that work in your project.

When the design matrices specify a DE for a design element, the DE documentation specifies the matrix and row, the design element, and the limits of the exception. Some DEs require justification. Include this in the DVIS. When a DVI is required for the project, the DE locations are recorded in the inventory.

Matrix Cell Contents	Design Element Meets Specified Design Level	Document to File ^[1]	Record in DVIS ^[2]
Blank cell in design matrix		No ^[3]	No
Cell Entry			
Full (F), Modified (M), or Basic (B) (with no DE or EU qualifiers)	Yes	No	No
	No ^[4]	Yes ^[5]	Yes
Design Exception (DE)	Yes ^[3]	DDP	No
	No	DDP	Yes
Evaluate Upgrade (EU)	Yes	DDP	No
	No ^[5]	DDP	Yes
DDP = Design Documentation Package Notes: [1] See 300.04(3). [2] See 300.04(2). [3] Document to the DDP if the element is included in the project as identified in the Project Summary or Project Change Request Form. [4] Nonconformance with specified design level (see Chapter 1100) requires an approved deviation. [5] Requires supporting justification (see 300.04(4)).			

Design Matrix Documentation Requirements

Exhibit 300-1

The EU process determines whether an item of work will or will not be done, through analysis of factors such as benefit/cost, route continuity, collision reduction potential, environmental impact, and economic development. Document all EU decisions to the DDP using the list in Exhibit 300-6 as a guide for the content. The cost of the improvement must always be evaluated when making EU decisions.

EU examples on the Internet can serve as models for development of EU documentation. The approval authority for EUs is in the region.

Deviation requests are stand-alone documents that require enough information and project description for an approving authority to make an informed decision of approval or denial. Documentation of a deviation contains justification and is approved at the appropriate administrative level, as shown in Exhibit 300-2. Submit the request as early as possible because known deviations are to be approved prior to Design Approval.

(5) Deviation Approval

Deviation approval is at the appropriate administrative level, as shown in Exhibit 300-2.

If the element meets current AASHTO guidance adopted by FHWA, such as *A Policy on Geometric Design of Highways and Streets*, but not *Design Manual* criteria, it is a deviation from the *Design Manual* that does not require approval by FHWA or the HQ Design Office. It does require region approval.

The following documentation is required:

- Identify the design element.
- Explain why the design level specified in the design matrices was not used.
- Explain which AASHTO guidance was used, including the title of the AASHTO guidance, the publication date, and the chapter and page number of the guidance.

When applying for deviation approval, it is necessary to provide two explanations. The first identifies the design element and explains why the design level specified in the design matrices was not or cannot be used. The second provides the justification for the proposed design. Justification for a deviation is to be supported by at least two explanations, which may include the following:

- Collision history and analysis
- Benefit/cost analysis
- Engineering judgment*
- Environmental issues
- Route continuity

*Engineering judgment may include a reference to another publication, with an explanation of why that reference is applicable to the situation encountered on the project.

To prepare a deviation request, use the list in Exhibit 300-7 as a general guide for the sequence of the content. The list is not all-inclusive of potential content and it might include suggested topics that do not apply to a particular project.

Reference a corridor or project analysis, if one exists, as supporting justification for design deviations dealing with route continuity issues (see Chapter 1100).

When several design variances are proposed in a corridor, and they have similar contributing factors or are intertwined in their effects on each other, they can sometimes be handled in a single project analysis. Coordinate this approach with your ASDE.

Once a design variance is approved, it applies to that project only. When a new project is programmed at the same location, the subject design element is to be reevaluated, and either the subject design element is rebuilt to conform to the applicable design level or a new deviation is developed, approved, and preserved in the DDP for the new project.

Check the DVIS for help in identifying previously granted deviations. Keep in mind that the *Design Manual* is continually evolving. What may have met guidelines once may not meet current guidelines.

A change in a design level resulting from an approved corridor planning study, or a corridor or project analysis as allowed in design matrix notes, is documented similar to a deviation. Use Exhibit 300-7 as a guide to the outline and contents of your project analysis. Design elements that do not comply with the design level specified in an approved corridor or project analysis are documented as deviations.

For design deviation examples, see: www.wsdot.wa.gov/design/projectdev

300.05 Project Development

In general, the region initiates the development of a specific project by preparing the Project Summary. Projects may also be initiated by other WSDOT groups such as the HQ Bridge and Structures Office or the HQ Traffic Office. The project coordination with other disciplines (such as Real Estate Services, Roadside and Site Development, Utilities, and Environmental) is started in the project scoping phase and continues throughout the project's development. The region coordinates with state and federal resource agencies and local governments to provide and obtain information to assist in developing the project.

The project is developed in accordance with all applicable Directives, Instructional Letters, Supplements, and manuals; the Limited Access and Managed Access Master Plan; the Washington State Highway System Plan; approved corridor planning studies; the Washington Federal-Aid Highway Stewardship Agreement as implemented in the design matrices (see Chapter 1100); and the Project Summary.

The region develops and maintains documentation for each project. The Project File/Design Documentation Package includes documentation of project work, including planning; scoping; public involvement; environmental action; design decisions; right of way acquisition; Plans, Specifications, and Estimates (PS&E) development; project advertisement; and construction. Refer to the *Plans Preparation Manual* for PS&E documentation. Exhibit 300-8 is an example checklist of recommended items to be turned over to the construction office at the time of project transition. An expanded version is available here: www.wsdot.wa.gov/design/projectdev/

All projects involving a federal action require NEPA clearance. WSDOT uses the ECS form for FHWA concurrence/approval on the environmental class of action (EIS, EA, or CE). The environmental approval levels are shown in Exhibit 300-3.

Upon receipt of the ECS approval for projects requiring an EA or EIS under NEPA, the region proceeds with environmental documentation, including public involvement, appropriate for the magnitude and type of the project (see Chapter 210).

Design Approval and approval of right of way plans are required prior to acquiring property. If federal funds are used to purchase the property, then NEPA clearance is also required.

The ASDEs work with the regions on project development and conduct process reviews on projects as described in 300.09.

(1) Scoping Phase

Development of the project scope is the initial phase of project development. This effort is prompted by the Washington State Highway System Plan. The project scoping phase consists of determining a project's description, schedule, and cost estimate. The intent is to make design decisions early in the project development process that focus the scope of the project. During the project scoping phase, the Project Summary documents are produced. For projects not covered by a matrix line from Chapter 1100, a project-specific matrix can be developed and approved at this phase.

(2) Project Summary

The Project Summary provides information on the results of the scoping phase; links the project to the Washington State Highway System Plan and the Capital Improvement and Preservation Program (CIPP); and documents the design decisions, the environmental classification, and agency coordination. The Project Summary is developed and approved before the project is funded for design and construction, and it consists of ERS, DD, and PD documents. The Project Summary database contains specific online instructions for completing the documents.

(a) Environmental Review Summary (ERS)

The ERS lists the potential required environmental permits and approvals, environmental classifications, and environmental considerations. If there is a change in the PD or DD, the information in the ERS must be reviewed and revised to match the rest of the Project Summary. The ERS is prepared during the scoping phase and is approved by the region. For actions classified under NEPA, the approved ERS becomes the ECS. If the NEPA class of action is a CE or DCE, the region may revise the ECS as appropriate (usually during final design). The region approves the ECS and sends it to FHWA for its approval (DCE only). During final design and permitting, revisions may need to be made to the ERS and be reapproved by the region. (See the *Environmental Procedures Manual* for more detail.)

(b) Design Decisions (DD)

The DD generally provides the design matrix used to develop the project, as well as the roadway geometrics, design variances, other roadway features, roadside restoration, and any design decisions made during the scoping of a project. The information contained in this form is compiled from various databases of departmental information, field data collection, and evaluations made in development of the PD and the ERS. Design decisions may be revised throughout the project development process based on continuing evaluations.

The appropriate ASDE concurs with the Design Decisions for all projects requiring a DD. The region design authority approves the DD when confident there will be no significant change in the PD or estimated cost. Schedule, scope, or cost changes require a Project Change Request Form to be submitted and approved by the appropriate designee, in accordance with the *Project Control and Reporting Manual*.

(c) Project Definition (PD)

The PD identifies the various disciplines and design elements that are anticipated to be encountered in project development. It also states the purpose and need for the project, the program categories, and the recommendations for project phasing. The PD is completed early in the scoping phase to provide a basis for full development of the ERS, DD, schedule, and estimate. If circumstances necessitate a change to an approved PD, process a Project Change Request Form for approval by the appropriate designee.

300.06 FHWA Approval

For all National Highway System (NHS) projects, the level of FHWA oversight varies according to the type of project, the agency doing the work, and the funding source, as shown in Exhibit 300-2. Oversight and funding do not affect the level of design documentation required for a project.

FHWA approval is required for any new or revised access point (including interchanges, temporary access breaks, and locked gate access points) on the Interstate System, regardless of funding (see Chapter 550).

Documents for projects requiring FHWA review, Design Approval, and Project Development Approval are submitted through the HQ Design Office. Include the applicable project documents specified in Exhibit 300-5.

300.07 Design Approval

When the Project Summary documents are complete, and the region is confident that the proposed design adequately addresses the purpose and need for the project, a Design Approval may be pursued and granted at this early stage. Early approval is an option at this point in the design phase and is likely most relevant to larger projects with longer PE phases because it provides early, approved documentation that locks in design policy for three years. This is a benefit for longer PE phases in that it avoids design changes due to policy updates during that time and provides consistency when purchasing right of way or producing environmental documentation.

If early Design Approval is not beneficial for a subject project, the typical items (below) that are part of this package become required in the combined Design Approval/Project Development Approval Package. Design Approval may occur prior to NEPA approval. Approval levels for design and PS&E documents are presented in Exhibits 300-2 through 300-4.

The following items are typically provided for Design Approval:

- Stamped cover sheet (project description).
- A reader-friendly memo that describes the project.
- Project Summary documents.
- Corridor or project analysis.
- Design Variance Inventory (for known design variances at this stage).
- Design Criteria worksheets or equivalent:  www.wsdot.wa.gov/design/projectdev
- Channelization plans, intersection plans, or interchange plans (if applicable).
- Alignment plans and profiles (if project significantly modifies either the existing vertical or horizontal alignment).
- Current cost estimate with a confidence level.

Design Approval is entered into the Design Documentation Package and remains valid for three years or as approved by the HQ Design Office. Evaluate policy changes or revised design criteria that are adopted by the department during this time to determine whether these changes would have a significant impact on the scope or schedule of the project. If it is determined that these changes will not be incorporated into the project, document this decision with a memo from the region Project Development Engineer that is included in the DDP. For an overview of design policy changes, consult the Detailed Chronology of *Design Manual* revisions: www.wsdot.wa.gov/design/policy/default.htm

(1) Alternative Project Delivery Methods

Design Approval applies to projects delivered using alternative means, including design-build projects. Design documentation begins in the project scoping phase and continues through the life of the design-build project. This documentation is thus started by WSDOT and is completed by the design-builder. Since Design Approval is related to project scoping, this milestone may be accomplished prior to issuing a Design-Build Request for Proposal (see Exhibit 110-1). However, the design-builder shall refer to the RFP for direction on approval milestones.

300.08 Project Development Approval

When all project development documents are completed and approved, Project Development Approval is granted by the approval authority designated in Exhibit 300-2. The Project Development Approval becomes part of the DDP. (See 300.04 and Exhibit 300-5 for design documents that may lead to Project Development Approval.) Exhibits 300-2 through 300-4 provide approval levels for project design and PS&E documents.

The following items must be approved prior to Project Development Approval:

- Required environmental documentation
- Design Approval documents (and any supplements)
- Updated Design Variance Inventory (all project design variances)
- Cost estimate
- Stamped cover sheet (project description)

Project Development Approval remains valid for three years. Evaluate policy changes or revised design criteria that are adopted by the department during this time to determine whether these changes would have a significant impact on the scope or schedule of the project. If it is determined that these changes will not be incorporated into the project, document this decision with a memo from the region Project Development Engineer that is included in the DDP. For an overview of design policy changes, consult the Detailed Chronology of *Design Manual* revisions: www.wsdot.wa.gov/design/policy/default.htm

(1) Alternative Project Delivery Methods

For projects delivered using alternative methods, such as design-build, the design-builder shall refer to the project RFP for specification on final and intermediate deliverables and final records for the project. Project Development Approval is required prior to project completion.

It is a prudent practice to start the compilation of design documentation early in a project and to acquire Project Development Approval before the completion of the project. At the start of a project, it is critical that WSDOT project administration staff recognize the importance of all required documentation and how it will be used in the design-build project delivery process.

300.09 Process Review

The process review is done to provide reasonable assurance that projects are prepared in compliance with established policies and procedures and that adequate records exist to show compliance with state and federal requirements. Process reviews are conducted by WSDOT, FHWA, or a combination of both.

The design and PS&E process review is performed in each region at least once each year by the HQ Design Office. The documents used in the review process are the Design Documentation Checklist, the PS&E Review Checklist, and the PS&E Review Summary. These are generic forms used for all project reviews. Copies of these working documents are available for reference when assembling project documentation. The HQ Design Office maintains current copies at: www.wsdot.wa.gov/design/projectdev

Each project selected for review is examined completely and systematically beginning with the scoping phase (including planning documents) and continuing through contract plans and, when available, construction records and change orders. Projects are normally selected after contract award. For projects having major traffic design elements, the HQ Traffic Operations Office is involved in the review. The WSDOT process reviews may be held in conjunction with FHWA process reviews.

The HQ Design Office schedules the process review and coordinates it with the region and FHWA.

(1) Process Review Agenda

A process review follows this general agenda:

1. Review team meets with region personnel to discuss the object of the review.
2. Review team reviews the design and PS&E documents, construction documents, and change orders (if available) using the checklists.
3. Review team meets with region personnel to ask questions and clarify issues of concern.
4. Review team meets with region personnel to discuss findings.
5. Review team submits a draft report to the region for comments and input.
6. If the review of a project shows a serious discrepancy, the region design authority is asked to report the steps that will be taken to correct the deficiency.
7. Process review summary forms are completed.
8. Summary forms and checklists are evaluated by the State Design Engineer.
9. Findings and recommendations of the State Design Engineer are forwarded to the region design authority for action and/or information within 30 days of the review.

Project Design	FHWA Oversight Level	Deviation and Corridor/Project Approval ^{[1][2]}	EU Approval ^[2]	Design and Project Development Approvals
Interstate				
New/Reconstruction ^[3] Federal funds No federal funds	[4] [5]	FHWA	Region	FHWA ^[10]
Intelligent Transportation Systems (ITS) Improvement project over \$1 million Preservation project	[6] [6]	HQ Design HQ Design	Region Region	HQ Design Region
All Other ^[7] Federal funds State funds Local agency funds	[6] [6] [5]	HQ Design	Region	Region
National Highway System (NHS)				
Managed access highway outside incorporated cities and towns or inside unincorporated cities and towns, or limited access highway	[6]	HQ Design	Region	Region
Managed access highway within incorporated cities and towns ^[8] Inside curb or EPS ^{[9][13]} Outside curb or EPS	[6] [6]	HQ Design HQ H&LP	Region N/A	Region City/Town
Non-National Highway System (Non-NHS)				
Improvement project on managed access highway outside incorporated cities and towns or within unincorporated cities and towns, or on limited access highway (Matrix lines 5-8 through 5-27)	N/A	HQ Design	Region	Region
Improvement project on managed access highway within incorporated cities and towns ^[6] Inside curb or EPS ^{[9][13]} Outside curb or EPS (Matrix lines 5-8 through 5-27)	N/A N/A	HQ Design HQ H&LP	Region N/A	Region City/Town
Preservation project on managed access highway outside incorporated cities and towns or within unincorporated cities and towns, or on limited access highway ^[11] (Matrix lines 5-1 through 5-7)	N/A	Region ^[12]	Region	Region
Preservation project on managed access highway within incorporated cities and towns ^{[8][11]} Inside curb or EPS ^{[9][13]} Outside curb or EPS (Matrix lines 5-1 through 5-7)	N/A N/A	Region HQ H&LP	Region N/A	Region City/Town

For table notes, see the following page.

Design Approval Level

Exhibit 300-2

FHWA = Federal Highway Administration
HQ = WSDOT Headquarters
H&LP = WSDOT Highways & Local Programs Office
EPS = Edge of paved shoulder where curbs do not exist

Notes:

- [1] These approval levels also apply to deviation processing for local agency work on a state highway.
- [2] See 300.04(4).
- [3] For definition, see Chapter 1100.
- [4] Requires FHWA review and approval (full oversight) of design and PS&E submitted by HQ Design Office.
- [5] To determine the appropriate oversight level, FHWA reviews the Project Summary (or other programming document) submitted by the HQ Design Office or by WSDOT Highways & Local Programs through the HQ Design Office.
- [6] FHWA oversight is accomplished by process review (see 300.09).
- [7] Reduction of through lane or shoulder widths (regardless of project type) requires FHWA review and approval of the proposal, except shoulder reductions as allowed by 1140.09 for seismic retrofit projects.
- [8] Applies to the area within the incorporated limits of cities and towns.
- [9] Includes raised medians.
- [10] FHWA will provide Design Approval prior to NEPA Approval, but will not provide Project Development Approval until NEPA is complete.
- [11] For Bridge Replacement projects in the Preservation program, follow the approval level specified for Improvement projects.
- [12] For guidance on access deviations, see Chapters 530 and 540.
- [13] Curb ramps are still included (see Chapter 1510).

Design Approval Level
Exhibit 300-2 (continued)

Item	Approval Authority		
	Region	HQ	FHWA
Program Development			
Work Order Authorization		X	X ^[1]
Public Hearings			
Corridor Hearing Summary		X ^[2]	
Design Summary		X ^[3]	
Access Hearing Plan		X ^[4]	
Access Findings and Order		X ^[5]	
Environmental Document			
Environmental Classification Summary (ECS) NEPA			X
Class I NEPA (EIS)		[7]	X
SEPA (EIS)		X	
Class II NEPA – Categorical Exclusion (CE)* (Per MOU)	X		
Class II NEPA – Documented Categorical Exclusion (DCE)	[6]		X
SEPA – Categorical Exemption (CE)	X		
Class III NEPA – Environmental Assessment (EA)		[7]	X
SEPA <u>Environmental Checklist & Determination of Non-Significance (DNS)</u>	X		
Design			
Experimental Features		X	X ^[9]
Environmental Review Summary	X		
Final Design Decisions	X	X ^[3]	
Final Project Definition		X ^[10]	
Interstate Interchange Justification Report		[7]	X
<u>Any Break in Interstate Limited Access</u>		[7]	<u>X</u>
Non-Interstate Interchange Justification Report		X	
Break in Partial or Modified Limited Access		X	
<u>Intersection or Channelization Plans</u>	X ^[11]		
Right of Way Plans	[12]	X	
Monumentation Map	X		
Materials Source Report		X ^[13]	
Pavement Determination Report		X ^[13]	
Roundabout Geometric Design (see Chapter 1320 for guidance)	X		
Resurfacing Report		X ^[13]	

Table is continued on the following page, which also contains the notes.

Approvals
Exhibit 300-3

Item	Approval Authority		
	Region	HQ	FHWA
Design (continued)			
Signal Permits	X ^[14]		
Geotechnical Report		X ^[13]	
Tied Bids	X ^[15]		X ^{[9][15]}
Bridge Design Plans (Bridge Layout)	X	X	
Hydraulic Report	X ^[16]	X ^[16]	
Preliminary Signalization Plans		X ^{[6][20]}	
Signalization Plans	X ^[22]		
Illumination Plans	X ^[22]		
Intelligent Transportation System (ITS) Plans	X ^[22]		
ITS Project Systems Engineering Review Form (Exhibit 1050-2a)	X ^[22]		X ^[1]
Rest Area Plans		X	
Roadside Restoration Plans	X ^[18]	X ^[19]	
Structures Requiring TS&Ls		X	X
Planting Plans	X ^[18]	X ^[19]	
Grading Plans	X		
Continuous Illumination – Main Line		X ^[20]	
Tunnel Illumination		X ^[20]	
High Mast Illumination		X ^[20]	
Project Change Request Form	X ^[21]	X ^[21]	
Work Zone Transportation Management Plan/Traffic Control Plan	X ^[22]		
Public Art Plan – Interstate (see Chapter 950)	X ^{[18][23]}	X ^{[19][23]}	X ^{[9][19][23]}
Public Art Plan – Non-Interstate (see Chapter 950)	X ^{[18][23]}	X ^{[19][23]}	
ADA Maximum Extent Feasible Document (see Chapter 1510)	X	X	

X Normal procedure *If on the preapproved list

Notes:

- | | |
|--|---|
| [1] Federal-aid projects only. | [13] Submit to HQ Materials Laboratory for review and approval. |
| [2] Approved by Environmental and Engineering Programs Director. | [14] Approved by Regional Administrator or designee. |
| [3] Approved by State Design Engineer. | [15] See 23 CFR 635.111. |
| [4] Approved by Right of Way Plans Manager. | [16] See the <i>Hydraulics Manual</i> for approvals levels. |
| [5] Refer to Chapter 210 for approval requirements. | [18] Applies only to regions with a Landscape Architect. |
| [6] Final review & concurrence required at the region level prior to submittal to approving authority. | [19] Applies only to regions without a Landscape Architect. |
| [7] Final review & concurrence required at HQ prior to submittal to approving authority. | [20] Approved by State Traffic Engineer. |
| [9] Applies to new/reconstruction projects on Interstate routes. | [21] Consult HQ Project Control & Reporting for clarification on approval authority. |
| [10] Approved by HQ Project Control & Reporting. | [22] Region Traffic Engineer <u>or</u> designee. |
| [11] Include channelization details. | [23] The State Bridge and Structures Architect reviews and approves the public art plan (see Chapter 950 for further details on approvals). |
| [12] Certified by the responsible professional licensee. | |

Approvals
Exhibit 300-3 (continued)

Item	New/Reconstruction (Interstate only)	NHS and Non-NHS
DBE/training goals* **	(a)	(a)
Right of way certification for federal-aid projects	FHWA ^(b)	FHWA ^(b)
Right of way certification for state-funded projects	Region ^(b)	Region ^(b)
Railroad agreements	(c)	(c)
Work performed for public or private entities*	[1][2]	Region ^{[1][2]}
State force work*	FHWA ^{[3](d)}	Region ^{[3](d)}
Use of state-furnished stockpiled materials*	FHWA ^[4]	FHWA ^[4]
Stockpiling materials for future projects*	FHWA ^[4]	FHWA ^[4]
Work order authorization	[5](d)	[5](d)
Ultimate reclamation plan approval through DNR	Region	Region
Proprietary item use*	FHWA ^[4]	[4](c)
Mandatory material sources and/or waste sites*	FHWA ^[4]	Region ^[4]
Nonstandard bid item use*	Region	Region
Incentive provisions	FHWA	(e)
Nonstandard time for completion liquidated damages*	FHWA ^(e)	(e)
Interim liquidated damages*	(f)	(f)

Notes:

- [1] This work requires a written agreement.
 [2] Region approval subject to \$250,000 limitation.
 [3] Use of state forces is subject to \$60,000 limitation and \$100,000 in an emergency situation, as stipulated in RCWs 47.28.030 and 47.28.035.
 [4] Applies only to federal-aid projects; however, document for all projects.
 [5] Prior FHWA funding approval required for federal-aid projects.

Region or Headquarters Approval Authority:

- (a) Office of Equal Opportunity
 (b) HQ Real Estate Services Office
 (c) HQ Design Office
 (d) Project Control & Reporting Office
 (e) HQ Construction Office
 (f) Transportation Data Office

References:

*Plans Preparation Manual

**Advertisement and Award Manual

PS&E Process Approvals

Exhibit 300-4

Document ^[1]	Required for FHWA Oversight
Project Definition	X
Design Decisions Summary	X
Environmental Review Summary	X
Corridor or project analysis (see Chapter 1100)	X
Design Variance Inventory (and supporting information for DEs, EUs not upgraded, and deviations) ^[2]	X
Cost estimate	X
NEPA documentation	X
Design Clear Zone Inventory (see Chapter 1600)	X
Interchange plans, profiles, roadway sections	X
Interchange justification report (if requesting new or revised access points)	X
Traffic projections and analysis	
Collision analysis	
Right of way plans	
Work zone traffic control strategy	
Record of Survey or Monumentation Map	
Documentation of decisions to differ from WSDOT design guidance	
Documentation of decisions for project components for which there is no WSDOT design guidance	
Paths and Trails Calculations ^[3]	
Project Change Request Forms	

Notes:

[1] For a complete list, see the Design Documentation Checklist.

[2] Required for all highways.

[3] See the *Plans Preparation Manual*.

Common Components of Design Documentation Package

Exhibit 300-5

1. **Design Element Upgraded to the Level Indicated in the Matrix**
 - (a) Design element information
 - Design element
 - Location
 - Matrix number and row
 - (b) Cost estimate^[1]
 - (c) B/C ratio^[2]
 - (d) Summary of the justification for the upgrade^[3]

2. **Design Element Not Upgraded to the Level Indicated in the Matrix**
 - (a) Design element information
 - Design element
 - Location
 - Matrix number and row
 - (b) Existing conditions
 - Description
 - Collision Summary
 - Advantages and disadvantages of leaving the existing condition unchanged
 - (c) Design using the *Design Manual* criteria
 - Description
 - Cost estimate^[1]
 - B/C ratio^[2]
 - Advantages and disadvantages of upgrading to the level indicated in the matrix
 - (d) Selected design, if different from existing but less than the level indicated in the matrix
 - Description
 - Cost estimate^[1]
 - B/C ratio^[2]
 - Advantages and disadvantages of the selected design
 - (e) Summary of the justification for the selected design^[3]

Notes:

- [1] An estimate of the approximate total additional cost for the proposed design. Estimate may be based on experience and engineering judgment.
- [2] Include only when B/C is part of the justification. An approximate value based on engineering judgment may be used.
- [3] A brief (one or two sentence) explanation of why the proposed design was selected.

Evaluate Upgrade (EU) Documentation Contents List*Exhibit 300-6*

1. **Overview**
 - (a) The safety or improvement need that the project is to meet
 - (b) Description of the project as a whole
 - (c) Highway classification and applicable design matrix number and row
 - (d) Funding sources
 - (e) Evidence of deviations approved for previous projects (same location)

2. **Design Alternatives in Question**
 - (a) Existing conditions and design data
 - Location in question
 - Rural, urban, or developing
 - Approved corridor study
 - Environmental issues
 - Right of way issues
 - Number of lanes and existing geometrics
 - Current and 20-year projected ADT
 - Design speed, posted speed, and operating speed
 - Percentage of trucks
 - Terrain Designation
 - Managed access or limited access
 - (b) Collision Summary and Analysis
 - (c) Design using the *Design Manual* criteria
 - Description
 - Cost estimate
 - B/C ratio
 - Advantages and disadvantages
 - Reasons for considering other designs
 - (d) Other alternatives (may include “No-build” alternative)
 - Description
 - Cost estimate
 - B/C ratio
 - Advantages and disadvantages
 - Reasons for rejection
 - (e) Selected design requiring justification or documentation to file
 - Description
 - Cost estimate
 - B/C ratio
 - Advantages and disadvantages

3. **Concurrences, Approvals, and Professional Seals**

Deviation Request and Project Analysis Contents List

Exhibit 300-7

This checklist is recommended for use when coordinating project transition from design to construction.

1. Survey

- End areas (cut & fill)
- Staking data
- Horizontal/Vertical control
- Monumentation/control information

2. Design Backup

- Index for all backup material
- Backup calculations for quantities
- Geotech shrink/swell assumptions
- Design decisions and constraints
- Approved deviations & project/corridor analysis
- Hydraulics/Drainage information
- Clarify work zone traffic control/workforce estimates
- Geotechnical information (report)
- Package of as-builts used (which were verified) and right of way files
- Detailed assumptions for construction CPM schedule (working days)
- Graphics and design visualization information (aerials)
- Specific work item information for inspectors (details not covered in plans)
- Traffic counts
- Management of utility relocation

3. Concise Electronic Information With Indices

- Detailed survey information (see Survey above)
- Archived InRoads data
- Only one set of electronic information
- "Storybook" on electronic files (what's what)
- CADD files

4. Agreements, Commitments, and Issues

- Agreements and commitments by WSDOT
- RES commitments
- Summary of environmental permit conditions/commitments
- Other permit conditions/commitments
- Internal contact list
- Construction permits
- Utility status/contact
- Identification of the work elements included in the Turnback Agreement (recommend highlighted plan sheets)

5. Construction Support

- Assign a Design Technical Advisor (Design Lead) for construction support

An expanded version of this checklist is available: www.wsdot.wa.gov/design/projectdev

Design to Construction Transition Project Turnover Checklist Example

Exhibit 300-8

305.01	Introduction
305.02	References
305.03	Definitions
305.04	Design Project Management Overview
305.05	Cost Estimating for Design Project Development
305.06	Value Engineering
305.07	Context Sensitive Solutions (CSS)
305.08	Additional Design Resources

305.01 Introduction

This chapter outlines the principles and methodology adopted by the Washington State Department of Transportation (WSDOT) for successful project management. WSDOT's project management process is the standard practice adopted by the department to manage projects, and it provides a method to meet WSDOT's Management Principles. This chapter focuses on preconstruction activities such as cost estimating, risk management, task planning, schedule development, and budgeting, as well as managing scope, schedule, and budget.

The WSDOT Secretary's Executive Orders 1028.01, 1032.01, 1038.00, 1042.00, and 1053.00 were issued to ensure a consistent process for context sensitive solutions (CSS), design project management, and risk-management statewide. (See Chapter 130 for more information about CSS.)

WSDOT's project management process includes "best management practices" and the tools, templates, examples, and guidance necessary to successfully deliver Capital Transportation projects. The process will enhance communications when designers hand off projects to construction project management.

Following are brief discussions about and links to other WSDOT project development resources. These include technical manuals, research reports, and online design-related websites.

305.02 References

(1) *Federal/State Laws and Codes*

23 United States Code (USC) 106, Project approval and oversight

(2) *WSDOT Policies*

Directives, Executive Orders, Instructional Letters, Manuals, and Policy Statements

<http://wwwi.wsdot.wa.gov/publications/policies/default.htm>

Executive Order E 1028, Context Sensitive Solutions

<http://wwwi.wsdot.wa.gov/publications/policies/fulltext/1028.pdf>

Executive Order E 1032, Project Management

<http://wwwi.wsdot.wa.gov/publications/policies/fulltext/1032.pdf>

Executive Order E 1038, Enterprise Risk Management

<http://wwwi.wsdot.wa.gov/publications/policies/fulltext/1038.pdf>

Executive Order E 1042, Project Management and Reporting System (PMRS)

<http://wwwi.wsdot.wa.gov/publications/policies/fulltext/1042.pdf>

Executive Order E 1053, Project Risk Management and Risk Based Estimating

<http://www.wsdot.wa.gov/publications/fulltext/cevp/1053policy.pdf>

Instructional Letter IL 4071.01, Risk-Based Project Estimates for Inflation Rates, Market Conditions, and Percentile Selection

<http://wwwi.wsdot.wa.gov/publications/policies/fulltext/4071.pdf>

Project Delivery Memos

<http://www.wsdot.wa.gov/design/projectdev/memos.htm>

305.03 Definitions

For a complete glossary of project management terms, see:

http://www.wsdot.wa.gov/projects/projectmgmt/online_guide/tools/wsdot_pm_glossary.pdf

For a complete glossary of cost estimating and risk assessment terms, see:

<http://www.wsdot.wa.gov/nr/rdonlyres/d10b9b96-9c03-479c-8b52-17ff7bff9a0f/0/glossaryofterms.doc>

For cost estimating definitions, see:

<http://www.wsdot.wa.gov/publications/manuals/m3034.htm>

305.04 Design Project Management Overview

WSDOT's project management process provides the framework for project managers to deliver projects on time and within scope and budget. WSDOT employs a number of tools to manage projects effectively and efficiently.

(1) Project Management Process

(a) Overview

For an overview of project management, with links to the WSDOT project management process for delivering the WSDOT Capital Construction Program, see the following website: <http://www.wsdot.wa.gov/projects/projectmgmt>

Exhibit 305-1 shows the five steps in the project management process used to deliver Capital Transportation projects. The following link takes you to a table with a more detailed description of the five steps: http://www.wsdot.wa.gov/nr/rdonlyres/a76c71ef-c926-4a13-9615-c9f341f3baaf/0/wsdotproj_mgmt_process.pdf

(b) Design Process Deliverables

The following website will take you to the Deliverable Expectation Matrix, which identifies the appropriate design process deliverable cells in the Master Deliverables List (see 305.04(2)(b)):

<http://www.wsdot.wa.gov/publications/fulltext/design/demintro.pdf>

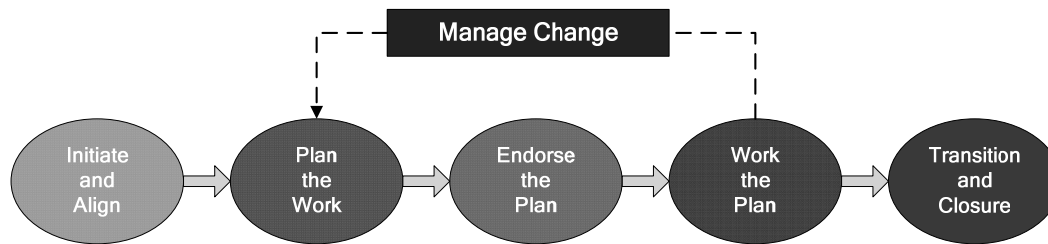

WSDOT Project Management Process

Exhibit 305-1

(2) Project Management Tools

(a) Project Management and Reporting System (PMRS)

The PMRS is a tool for effective and efficient management of design project schedules, resources, and costs. The following website provides tools for project planning, work breakdown structure (WBS) development, scheduling, and resource and cost management: <http://wwwi.wsdot.wa.gov/planning/cpdm/pmrs.htm>

(b) WSDOT's Master Deliverables List (MDL)

The Master Deliverables List (MDL) is a comprehensive listing of project elements. This list is agreed upon across WSDOT and is intended as a starting point for the creation of the project Work Breakdown Structure (WBS) and to ensure:

- All appropriate project elements are included in the project management plan and schedule.
- The MDL activity codes, related titles, and descriptions provide a common vocabulary across all projects and between project teams, region and Headquarters (HQ) management, and specialty/support groups.

For additional information, see:

<http://www.wsdot.wa.gov/projects/projectmgmt/masterdeliverables.htm>

305.05 Cost Estimating for Design Project Development

Cost estimating guidance has been developed by the Strategic Assessment and Estimating Office (SAEO) and WSDOT Project Development.

(1) Project Phases

There are four main phases or levels of design project development:

- Planning
- Scoping
- Design
- Plans, Specifications, and Estimates (PS&E)

The estimate for each level of project development has a specific purpose, methodology, and expected level of accuracy. As the project progresses, more data are available and the expected accuracy range narrows. For more information, see the *Cost Estimating Manual for WSDOT Projects*.

(a) Planning

The planning-level estimate is used to estimate the funding needs for long-range planning and to prioritize needs for the Highway System Plan. These estimates are typically prepared with little project definition detail.

(b) Scoping

A scoping-level estimate is used to set the baseline cost for the project and to program the project. A project is programmed when it is entered into the Capital Improvement and Preservation Program (CIPP) and the Biennial Transportation Program. The scoping estimate is important because it is the baseline used by the Legislature to set the budget, and all future estimates will be compared against it.

(c) Design

Estimates prepared at the various design levels, including Geometric Review, General Plans Review, and Preliminary Contract Review, are used to track changes in the estimated cost to complete the project in relation to the current budget (CIPP or “Book” amount).

Design Approval is an important stage of design for estimating purposes. At Design Approval, the configuration of the project is known. This will solidify many items in the scope, such as right of way needs, likely permit conditions, environmental mitigation, quantities of major items, and outside stakeholders. As scope definition improves, the accuracy of the estimate will likewise improve. The work effort required to prepare, document, and review the estimate also increases.

An important element of the project is the Basis of Estimate (BOE). The BOE is a documented record of pertinent communications that have occurred and agreements that have been made between the estimator and other project stakeholders. The BOE, which is to be included in the Project File, is characterized as *the one deliverable that defines the scope of the project*, and it ultimately becomes *the basis for change management*. For guidance in developing the BOE, and a template to help in its preparation, see the *Cost Estimating Manual for WSDOT Projects*.

(d) PS&E

The Engineer’s Estimate (part of PS&E) is prepared for the Final Contract Review in preparation for advertisement, and it is used to obligate construction funds and evaluate contractors’ bids.

(2) Risk Management

Project risks can be “opportunities” (positive events) as well as “threats” (negative events) that might affect scope, schedule, or budget. Risk assessment is the first phase of project risk management. Its purpose is to maximize the results of positive events and minimize the consequences of adverse events. For more information on risk assessment, see:

☞ <http://www.wsdot.wa.gov/projects/projectmgmt/riskassessment/>

(a) Design Project Risk Management Process**1. Risk Management Planning**

Using a systematic process, determine how to approach, plan, and execute risk management activities throughout the life of a design project.

2. Identify Risk Events

Determine which risks might affect the design project and document their characteristics. It may be a simple risk assessment organized by the design project team or an outcome of the CEVP/CRA workshop process.

3. Qualitative Risk Analysis

Assess the impact and likelihood of the identified risk and develop prioritized lists of these risks for further analysis or direct mitigation. The design team should elicit assistance from subject matter experts or functional units to assess the risks in their respective fields.

4. Quantitative Risk Analysis

Numerically estimate the probability that the design project will meet its cost and time objectives. Quantitative analysis is based on a simultaneous evaluation of the impacts of all identified and quantified risks.

5. Risk Response Planning

Develop options and determine actions to enhance opportunities and reduce threats to the design project's objectives.

6. Risk Monitoring and Control

Track and monitor the impact of identified risks, monitor residual risks, and identify new risks, ensuring the execution of risk plans, and evaluate their effectiveness in reducing risk or enhancing opportunities. Risk Monitoring and Control is an ongoing process for the life of the design project.

For more information on risk planning and risk management, see:

<http://www.wsdot.wa.gov/publications/fulltext/cevp/projectriskmanagement.pdf>

(b) Inclusion of Formal Risk: CRA, CEVP

WSDOT policy requires a cost risk assessment (CRA) for projects over \$25 million and a cost estimate validation process (CEVP) for projects over \$100 million. Both of these processes include an estimate review.

It is recommended that all projects undergo at least an internal project team review for each estimate update.

- Consider a peer review or region review for each estimate that is complex or includes significant changes to scope or design development.
- Consider a region/HQ or external estimate review for all projects over \$10 million or for projects that are complex during the design phase.

Document each estimate review in the Project File, and clearly show any changes made to the estimate as a result of the review.

For more information, see *Project Risk Management: Guidance for WSDOT Projects*: <http://www.wsdot.wa.gov/publications/fulltext/cevp/projectriskmanagement.pdf>

For more information about CRAs and CEVPs, see:
<http://www.wsdot.wa.gov/projects/projectmgmt/riskassessment/default.htm>

305.06 Value Engineering

Value engineering (VE) is a systematic process that uses a team chosen from a variety of disciplines to improve the value of a project through the analysis of its functions. The VE process incorporates, to the greatest extent possible, the values of design; construction; maintenance; contractor; state, local and federal approval agencies; other stakeholders; and the public.

For additional information about value engineering, see Chapter 310.

305.07 Context Sensitive Solutions (CSS)

CSS is a model for transportation project development that considers the total context of a transportation project. Essentially, the CSS approach is that transportation projects must be designed for the physical aspects of facilities serving specific transportation objectives, as well as for a project's effect on the aesthetic, social, economic, and environmental needs and constraints.

Key issues for designers include:

- Access management
- Urban median design
- Bike and pedestrian access and safety
- Streetscaping
- Transit and freight
- Traffic calming
- Business access
- Operational intent of the facility
- Urban forestry

For guidance on incorporating Context Sensitive Design, see:

<http://www.wsdot.wa.gov/design/policy/csdesign>

305.08 Additional Design Resources

(1) Technical Manuals

There are many WSDOT technical manuals used in project development. A collection of the most recent versions is available at the Engineering Publications Services Index website: <http://www.wsdot.wa.gov/publications/manuals/index.htm>

(2) Administrative Manuals

Some administrative manuals (such as the *Advertisement and Award Manual* and the *Agreements Manual*) are used in project development. These manuals are available on WSDOT's internal Administrative Manuals website:

☞ <http://wwwi.wsdot.wa.gov/publications/manuals/>

(3) Transportation Research and Reports

The following WSDOT Research websites may be of interest during project development:

Understanding Flexibility in Transportation Design – Washington guidance manual:

☞ <http://www.wsdot.wa.gov/research/reports/600/638.1.htm>

Transportation Research home page: ☞ <http://www.wsdot.wa.gov/research/>

Research Reports Index: ☞ <http://www.wsdot.wa.gov/research/reports>

(4) Online Design Guidance

The Design Office's website provides links to various design-related resources and contacts: ☞ <http://www.wsdot.wa.gov/design/>

The Project Development home page is a design-related resource:

☞ <http://www.wsdot.wa.gov/design/projectdev/>

(5) Project Management Online Guide

The WSDOT Project Management Online Guide (PMOG) is an interactive website that includes links to project management tools and templates, to manuals and specifications, and examples of good practice.

☞ <http://www.wsdot.wa.gov/projects/projectmgmt/onlineguide/preconstruction.htm>

(6) Project Management and Reporting System (PMRS) Web Portal

WSDOT implemented the Project Management and Reporting System (PMRS) to assist with managing and reporting the status of capital transportation projects. PMRS provides WSDOT project managers with current business practices and integrated tools to assist with making good decisions on management of project scope, schedule, and cost.

☞ <http://wwwi.wsdot.wa.gov/planning/cpdmo/pmrs.htm>

1. Information/Investigation Phase	Gather information. Investigate background information, technical input reports, and field data. Develop team focus and objectives.
2. Function Analysis Phase	Define project functions using a two-word active verb/measurable noun context. Review and analyze these functions to determine which need improvement, elimination, or creation to meet the project's goals.
3. Creative/Speculation Phase	Be creative and brainstorm alternative proposals and solutions.
4. Evaluation Phase	Analyze design alternatives, technical processes, life cycle costs, documentation of logic, and rationale.
5. Development Phase	Develop technical and economic supporting data to prove the feasibility of the desirable concepts. Develop team recommendations. Recommend long-term as well as interim solutions.
6. Presentation Phase	Present the recommendations of the VE team to the project team and region management in an oral presentation, and provide a written report.
7. Implementation Phase 310.04(2)	Evaluate the recommendations. Prepare an implementation plan (VE Decision Document), including the response of the managers and a schedule for accomplishing the decisions based on the recommendations.

Note:

Phases 1–6 are performed during the study; see *Value Standard and Body of Knowledge* for procedures during these steps.

Seven-Phase Job Plan for VE Studies
Exhibit 310-1

Project-Related Input* (Study Package)
Collision data
Aerial photos
Contour maps
Cross sections and profiles
Design file
Environmental documents
Estimates
Existing as-built plans
Geotechnical reports
Hydraulic Report
Land use maps
Large-scale aerial photographs
Plan sheets
Quadrant maps
Quantities
Right of way plans
Traffic data
Vicinity map
Study-Related Facilities and Equipment
AASHTO Green Book
Bridge list
Calculators
Computer projector
<i>Design Manual</i>
Easel(s) and easel paper pads
Field tables
Marking pens
Masking and clear tape
Network computer access (if available)
Power strip(s) and extension cords
Room with a large table and adequate space for the team
Scales, straight edges, and curves
<i>Standard Plans</i>
<i>Standard Specifications</i>
State Highway Log
Telephone
Vehicle or vehicles with adequate seating to transport the VE team for a site visit**

* Not all information listed may be available to the team, depending on the project stage.

** If a site visit is not possible, provide video of the project.

VE Study Team Tools
Exhibit 310-2

400.01	General
400.02	References
400.03	Procedures
400.04	Datums
400.05	Global Positioning System
400.06	WSDOT <u>Survey</u> Monument Database
400.07	Geographic Information System
400.08	Photogrammetric Surveys
400.09	Documentation

400.01 General

The Washington State Department of Transportation (WSDOT) is permitted, by an agreement with the Board of Registration for Professional Engineers and Land Surveyors, to practice land surveying “under the direct supervision of a licensed professional land surveyor OR a licensed professional engineer” (see Exhibit 400-1, Interagency Agreement).

400.02 References

(1) Federal/State Laws and Codes

Revised Code of Washington (RCW) 58.09, Surveys – Recording

RCW 58.20.120, System designation – Permitted uses

RCW 58.24.040(8), “. . . temporary removal of boundary marks or monuments”

Washington Administrative Code (WAC) 332-120, Survey monuments – Removal or destruction

WAC 332-130, Minimum standards for land boundary surveys and geodetic control surveys and guidelines for the preparation of land descriptions

Interagency Agreement Between the Washington State Department of Transportation and the Board of Registration for Professional Engineers and Land Surveyors (1990)

(2) Design Guidance

Construction Manual, M 41-01, WSDOT

Highway Surveying Manual, M 22-97, WSDOT

Plans Preparation Manual, M 22-31, WSDOT

WSDOT Survey Monument Database

 www.wsdot.wa.gov/monument/

400.03 Procedures

For WSDOT projects, it is recommended that surveying activities include (if appropriate) but not be limited to the following items.

(1) Project Definition Phase

During the Project Definition phase, perform the following:

- (a) Record any pertinent surveying information as detailed in the Design Documentation Checklist: www.wsdot.wa.gov/design/projectdev/
- (b) Conduct research to find recorded survey monuments existing within the project area.
- (c) Determine and prioritize project survey needs and tasks to be completed. Needs and tasks may include the following issues:
 - Cadastral
 - Right of way
 - Geodetic
 - Photogrammetry
 - Other issues as needed

(2) Design and Development of the Plans, Specifications, and Estimates

During the design and development of the Plans, Specifications, and Estimates (PS&E), perform the following:

- (a) The project manager and project surveyor hold a preliminary survey meeting, regarding:
 - Project schedule.
 - Anticipated survey requests.

For preliminary survey meeting specifics and roles and responsibilities of the project manager and project surveyor, see the *Highway Surveying Manual*.

- (b) Perform field reconnaissance, mark existing recorded survey monuments, and determine the location of possible new survey monuments. Also, mark found unrecorded monuments for preservation if practical.
- (c) Determine the impact to geodetic monuments and notify the Headquarters (HQ) GeoMetrix Office.
- (d) Refer to the *Highway Surveying Manual* to:
 - Convert Washington State Plane Coordinates to project datum.
 - Document the procedure and combined factor used for converting between datums.
 - Determine survey collection methods.
 - Collect primary, secondary, and tertiary survey data.
 - Process and import secondary, tertiary, or other survey data into design software for use by designers.

- (e) Apply to the Department of Natural Resources (DNR) for permits for monuments that will be disturbed or removed (see Chapter 410).
- (f) Archive new primary and secondary survey control data in the WSDOT Monument Database and GIS, as appropriate, for future retrieval.
- (g) Ensure that all survey monuments within the project right of way are shown on the contract plans in order to avoid accidental damage.
- (h) Develop a Record of Survey (RCW 58.09) or a Monumentation Map as required (see Chapter 410).

(3) After Construction is Completed

- (a) Complete a post construction survey as described in the *Highway Surveying Manual*.
- (b) Have the DNR Completion Report signed and stamped by the appropriate professional in direct charge of the surveying work, then file with DNR as described in Chapter 410.

400.04 Datums

A datum is a geometrical quantity (or set of quantities) that serves as a reference, forming the basis for computation of horizontal and vertical control surveys in which the curvature of the earth is considered. Adjusted positions of the datum, described in terms of latitude and longitude, may be transformed into State Plane Coordinates.

All engineering work (mapping, planning, design, right of way, and construction) for WSDOT projects is based on a common datum.

(1) Horizontal

WAC 332-130-060 states, “The datum for the horizontal control network in Washington shall be NAD83 (1991) [the North American Datum of 1983] as officially adjusted and published by the National Geodetic Survey of the United States Department of Commerce and as established in accordance with chapter 58.20 RCW. The datum adjustment shall be identified on all documents prepared; i.e., NAD83 (1991).” (See the *Highway Surveying Manual* for further information.)

(2) Vertical

The North American Vertical Datum of 1988 (NAVD88) as defined by the National Geodetic Survey (NGS) is the official civilian datum for surveying and mapping activities in the United States. WSDOT has adopted this datum. (See the *Highway Surveying Manual* for further information.)

400.05 Global Positioning System

A Global Positioning System (GPS) uses a constellation of satellites and earth stationed receivers to determine geodetic positions (latitude and longitude) on the surface of the earth. WSDOT personnel use this survey technology. (See the *Highway Surveying Manual* for more detailed discussions.)

GPS technology is changing rapidly. The key point is for the designer and surveyor to select the best tool (GPS or conventional applications) for doing the survey fieldwork. Often, a combination of GPS and conventional (Total Station) surveying is appropriate.

400.06 WSDOT Survey Monument Database

The WSDOT Survey Monument Database provides storage and retrieval capabilities for data associated with survey control monuments set by WSDOT. This database supports and tracks the Report of Survey Mark and aids in fulfilling WSDOT's obligation to contribute to the body of public record, thereby minimizing the duplication of survey work. The Report of Survey Mark provides data on specific GPS stations. (See Exhibit 400-2 for an example of a Report of Survey Mark.)

To access the WSDOT Survey Monument Database, see the following website:

www.wsdot.wa.gov/monument/

400.07 Geographic Information System

The Geographic Information System (GIS) is a compilation of information from many sources. Its purpose is to assemble data into a central database for the common good. The data is stored on many levels so the desired information can be selected and combined to achieve the desired product. Surveying and photogrammetric data are vital elements of this system.

400.08 Photogrammetric Surveys

Photogrammetric surveys are performed to furnish topographic or planimetric maps and cross sections for use in the reconnaissance, location, and preliminary design phases of highway work. To use photogrammetric surveys for final design and construction requires that the ground be nearly bare to obtain the necessary accuracy. By using well-planned aerial photography in stereoscopic plotters, contours and other physical features are delineated on map sheets to a scale consistent with the accuracies or detail required.

The usefulness of aerial photography is not limited to mapping. Taking the form of enlargements, mosaics, and digital images, it can be used as a visual communication tool (displays and exhibits) for planning, design, property acquisition, engineering, construction, litigation, and public relations.

To obtain information on preparation, procedure, and programming of aerial photography and photogrammetric mapping and applications, contact the HQ GeoMetrix Office. When requesting a photogrammetric survey, specify the desired units and check the units of the product. Allow for the time required to communicate the complex and detailed work request, develop the service, and accomplish the product.

400.09 Documentation

For documentation related to monuments, see Chapter 410.

Primary and secondary survey control data are archived in the WSDOT Survey Monument Database and GIS when available.

For the list of documents required to be preserved in the Design Documentation Package and the Project File, see the Design Documentation Checklist:

www.wsdot.wa.gov/design/projectdev/

410.01	General
410.02	References
410.03	Definitions
410.04	Control Monuments
410.05	Alignment Monuments
410.06	Property Corners
410.07	Other Monuments
410.08	Filing Requirements
410.09	Documentation

410.01 General

Proper monumentation is important in referencing a highway's alignment, which is used to define its right of way. The Washington State Department of Transportation (WSDOT) can contribute to the body of public records and minimize duplication of survey work by establishing and recording monuments that are tied to a state plane coordinate system and to a standard vertical datum. WSDOT is required by law to perpetuate existing recorded monuments (RCW 58.09). The department provides monuments for realignments and new highway alignments and perpetuates existing monuments impacted by a project.

The Department of Natural Resources (DNR) is designated as the official agency for surveys and maps. New monuments set to establish property corners, highway alignment, and so on, shall be recorded on a Record of Survey or Monumentation Map and filed with the DNR Public Land Survey Office and the appropriate county auditor or county engineer. Records of Survey and Monumentation Maps are retained at DNR. Geodetic monuments are established and the Headquarters (HQ) GeoMetrix Office retains their placement records. Geodetic monuments are recorded on a Report of Survey Mark. These records are made available to the public on the following website: www.wsdot.wa.gov/monument/

Existing monuments are not to be disturbed without first obtaining the DNR permits required by state law. DNR allows the temporary covering of a string of monuments under a single permit. State law requires replacement of land boundary monuments after temporary removal according to permit procedures. WSDOT control and alignment monuments may not be removed without replacement unless the location of the original position is perpetuated by reference and the appropriate document(s) prepared and filed with the county and the HQ Right of Way Plans Section. Other requirements pertaining to specific monuments are discussed below.

Exhibit 410-1 summarizes the documentation requirements for new and existing monuments.

The region is responsible for identifying and locating existing monuments, obtaining required permits before any existing monument is disturbed, and conducting the research to locate existing monuments as required by WAC 332-120-030, as follows:

Any person, corporation, association, department, or subdivision of the state, county or municipality responsible for an activity that may cause a survey monument to be removed or destroyed shall be responsible for ensuring that the original survey point is perpetuated. It shall be the responsibility of the governmental agency or others performing construction work or other activity (including road or street resurfacing projects) to adequately search the records and the physical area of the proposed construction work or other activity for the purpose of locating and referencing any known or existing survey monuments.

410.02 References

(1) Federal/State Laws and Codes

Revised Code of Washington (RCW) 18.43, Engineers and land surveyors

RCW 58.09, Surveys – Recording

RCW 58.24, State agency for surveys and maps – Fees

Washington Administrative Code (WAC) 332-120, Survey monuments – Removal or destruction

WAC 332-130, Minimum standards for land boundary surveys and geodetic control surveys and guidelines for the preparation of land descriptions

(2) Design Guidance

Highway Surveying Manual, M 22-97, WSDOT

Manual of Instructions for the Survey of the Public Lands of the United States, BLM, U.S. Department of the Interior, 1973

410.03 Definitions

monument As defined for this chapter, a monument is any physical object or structure that marks or references a survey point. This includes, but is not limited to, a point of curvature (P.C.), a point of tangency (P.T.), a property corner, a section corner, a General Land Office (GLO) survey point, a Bureau of Land Management (BLM) survey point, and any other permanent reference set by a governmental agency or private surveyor.

removal or destruction The physical disturbance or covering of a monument such that the survey point is no longer visible or readily accessible.

410.04 Control Monuments

Horizontal and vertical control monuments are permanent references required for the establishment of project coordinates tied to the Washington State plane system and elevations tied to a standard vertical datum. By establishing and recording permanent control monuments, WSDOT eliminates duplication of survey work and contributes to the body of public records.

Provide the horizontal and vertical control monuments for highway projects that require the location of existing or proposed alignment or right of way limits. Monuments set by other agencies may be used if within 1 mile of the project and where the required datum and accuracy were used.

When control monuments are required for a given project, show the existing and proposed control monuments on the contract plans.

For horizontal control:

- Use North American Datum 1983, revised 1991 (NAD83/91).
- Use a minimum of second order, Class II procedures as defined in the *Highway Surveying Manual*.
- Provide two monuments near the beginning of the project. Where possible, when setting horizontal control, set points to act as azimuth points. Place points so that line of sight is preserved between them and in an area that will not be disturbed by construction.
- Provide two monuments near the end of the project.
- Provide a pair of monuments at about 3-mile intervals throughout the length of the project.

For vertical control:

- Use North American Vertical Datum 1988 (NAVD88). (See the *Highway Surveying Manual* for orders of accuracy required.)
- Use at least second order procedures for primary vertical control within project limits as defined in the *Highway Surveying Manual*. Use third order for secondary control throughout the project.
- Provide vertical control throughout the length of the project. Desirable spacing is at or near each milepost. Maximum spacing is 3 miles apart.

All control monuments that are established, reestablished, or reset must be filed with the county engineer and the Department of Natural Resources (DNR). Submit a Record of Survey or a Monumentation Map that has been signed by the supervising, licensed, professional engineer or licensed, professional land survey. If the monument is not used to reference right of way or land corners, submit a Report of Survey Mark. (See the *Highway Surveying Manual* for more detailed guidance on Control Monuments.)

410.05 Alignment Monuments

Alignment monuments are permanent references required for the establishment or reestablishment of the highway and its right of way. Placing monuments at random points, in safe locations and tied to the Washington State plane coordinate system is recommended (see the *Highway Surveying Manual*).

Establishment, reestablishment, or resetting of alignment monuments is required on the following highway projects:

- New highway alignment projects.
- Highway realignment projects involving new right of way (monuments are only required for the realigned highway section).
- Highway projects where alignment monuments already exist.

Before an existing alignment monument is reestablished or reset, a DNR permit is required.

All alignment monuments that are established, reestablished, or reset must be filed with the appropriate county auditor or county engineer. The Record of Survey is filed with the county auditor in the county in which the monument is located, and a recorded copy is sent to the HQ Right of Way Plans Section. The original Monumentation Map is filed with the county engineer of the county in which the monument is located, and a recorded copy, with the filing signatures, is sent to the HQ Right of Way Plans Section. The HQ Right of Way Plans Section will forward a copy to DNR for its records.

410.06 Property Corners

A new property corner monument will be provided where an existing recorded monument has been invalidated as a direct result of a right of way purchase by the department. The new property corner monument shall be set by or under the direct supervision of a licensed professional engineer or licensed professional land surveyor.

The licensed land surveyor files the Record of Survey with the county auditor. A recorded copy of the Record of Survey is sent to the HQ Right of Way Plans Section and HQ Real Estate Services. The licensed professional engineer files a Monumentation Map with the county engineer of the county in which the monument is located, and a recorded copy is sent to the HQ Right of Way Plans Section and HQ Real Estate Services.

410.07 Other Monuments

A DNR permit is required before any monument may be removed or destroyed.

Existing section corners and BLM or GLO monuments impacted by a project shall be reset to perpetuate their existence. After completing the work, a DNR Land Corner Record is required.

Other permanent monuments established by any other governmental agency must not be disturbed until the agency has been contacted to determine specific requirements for the monument. If assistance is needed to identify a monument, contact the HQ GeoMetrix Office.

Resetting monuments must be done by or under the direct supervision of a licensed professional engineer or a licensed professional land surveyor. If a Record of Survey is prepared, it will be filed with the county auditor in the county in which the monument is located. If a Monumentation Map is prepared, it is filed with the county engineer in the county in which the monument is located, and a recorded copy is sent to the HQ Right of Way Plans Section. The HQ Right of Way Plans Section will forward a copy to DNR for its records.

530.01	General
530.02	Achieving Limited Access
530.03	Full Control (Most Restrictive)
530.04	Partial Control
530.05	Modified Control (Least Restrictive)
530.06	Access Approaches
530.07	Frontage Roads
530.08	Turnbacks
530.09	Adjacent Railroads
530.10	Modifications to Limited Access Highways
530.11	Documentation

530.01 General

Limited access control is established to preserve the safety and efficiency of specific highways and to preserve the public investment. Limited access control is achieved by acquiring access rights from abutting property owners and by selectively limiting approaches to a highway. (For an overview of access control and the references list and definitions of terminology for this chapter, see Chapter 520, Access Control.)

Requirements for the establishment of limited access highways are set forth in Revised Code of Washington (RCW) 47.52. The level of limited access control is determined during the early stages of design in conformance with this chapter.

Highways controlled by acquiring abutting property owners' access rights are termed limited access highways and are further distinguished as having *full, partial, or modified* control. The number of access points per mile, the spacing of interchanges or intersections, and the location of frontage roads or local road/street approaches are determined by the:

- Functional classification and importance of the highway.
- Character of the traffic.
- Current and future land use.
- Environment and aesthetics.
- Highway design and operation.
- Economic considerations involved.

The Federal Highway Administration (FHWA) has jurisdiction on the Interstate System. The Washington State Department of Transportation (WSDOT) has full jurisdiction on all other limited access highways, whether they are inside or outside incorporated city limits.

WSDOT maintains a record of the status of limited access control, by state route number and milepost, in the Access Control Tracking System Limited Access and Managed Access Master Plan database. The database is available at:

 www.wsdot.wa.gov/design/accessandhearings

Nothing in this chapter is to be construed in any way that would prevent acquisition of short sections of full, partial, or modified control of access.

530.02 Achieving Limited Access

(1) Project Scoping Evaluation

The acquisition of full, partial, or modified control is to be evaluated during project scoping if the route is shown in the Access Control Tracking System Limited Access and Managed Access Master Plan database as either “established” or “planned” for limited access. The matrices in Chapter 1100 list several project types for which acquisition is indicated as a Design Element.

The cost of acquiring limited access must be evaluated during project scoping to determine whether those costs will be included in the project. The evaluation includes the societal costs of collisions, current and future land use development, and the improved level of service of limited access highways. This cost will be evaluated against the cost to realign the highway in the future if limited access is not acquired at current prices.

(2) Process

All Washington State highways are managed access highways (see Chapter 540), except where limited access rights have been acquired. The right of way and limited access plans for routes show the acquired limited access boundaries. This is further represented in the Access Control Tracking System, a database that identifies the status and type of access control for all state highways. The database lists the specific types of limited access control (full, partial, or modified) and identifies whether the control is planned, established, or acquired for a specific route segment. If limited access has not been acquired, the database reports the type of managed access classification that currently applies. For help determining the status of limited access control for any state highway, consult the Headquarters (HQ) Access and Hearings Section.

(a) Procedure for Limited Access Control

Use the following procedure to achieve limited access control:

1. The Secretary of Transportation (or a designee) first identifies a highway as “Planned for Limited Access.”
2. To establish or revise limited access on a new or existing highway, a limited access hearing is held. (See Chapter 210, Public Involvement and Hearings, regarding hearings, and Chapter 510, Right of Way, for the phases of appraisal and acquisition.)

a. Phase 1

The region develops a limited access report and a limited access report plan for department approval and presentation to local officials. The plan notes the level of limited access proposed to be established.

b. Phase 2

The region develops a limited access hearing plan for State Design Engineer (or designee) approval and for presentation at the hearing.

(3) **Interchanges and Intersections**

(a) **Interchanges**

Where an interchange occurs on a partial control limited access highway, full control applies at the interchange and interchange ramps. Refer to 530.03(3) and see Exhibits 530-1a, 1b, and 1c for required minimum lengths of access control along the crossroad. (See Chapter 1360 for guidance on interchange spacing.)

(b) **Intersections**

At an at-grade intersection on a partial control limited access highway, control will be established and acquired along the crossroad for a minimum distance of 300 feet from the centerline of the highway (see Exhibit 530-2a).

If another frontage or local road is located at or within 350 feet of the at-grade intersection, limited access will be established and then acquired along the crossroad, between the intersections, and:

- For an additional minimum distance of 130 feet in all directions from the centerline of the intersection of the frontage or local road (see Exhibit 530-2a).
- In the case of a roundabout, for an additional minimum distance of 300 feet along the crossroad, measured from the center of the roundabout (as shown in Exhibit 530-2b).

On multilane highways, measurements will be made from the centerline of the nearest directional roadway.

An approved access deviation is required if the limited access control falls short of 300 feet or for any access that has been allowed to remain within the first 130 feet.

At-grade intersections with public roads are limited to the number allowed for the functional classification of highway involved, as follows:

1. **Principal Arterial**

If the ADT of the crossroad is less than 2000, 1-mile spacing (minimum), centerline to centerline. If over 2000 ADT within 20 years, plan for grade separation.

2. **Minor Arterial**

If the ADT of the crossroad is less than 2000, ½-mile spacing (minimum), centerline to centerline. If over 2000 ADT within 20 years, plan for grade separation.

3. **Collector**

Road (or street) plus property approaches, not more than six per side per mile.

With approval from the State Design Engineer, shorter intervals may be used where topography or other conditions restrict the design. Where intersecting roads are spaced farther apart than one per mile, median crossings may be considered for U-turns, in accordance with Chapter 1310. Keep U-turns to a minimum, consistent with requirements for operation and maintenance of the highway.

To discourage movement in the wrong direction on multilane highways, locate private approaches 300 feet or more from an at-grade intersection. At a tee intersection, a private approach may be located directly opposite the intersection or a minimum of 300 feet away from the intersection. Ensure a private approach directly opposite a tee intersection cannot be mistaken for a continuation or part of the public traveled way.

(4) Access Approach

Partial control is exercised to the level that, in addition to intersections with selected public roads, some crossings and private driveways may be allowed.

(a) Approach Types

Partial control limited access highways allow at-grade intersections with selected public roads and private approaches using Type A, B, C, and F approaches. (See Chapter 520 for the definitions of approach types.)

Type D, commercial approaches, are not allowed direct access to partial control limited access highways. Commercial access is allowed only by way of public roads.

The type of approach provided for each parcel is based on current and potential land use and on an evaluation. (See 530.05(4) for a list of evaluation criteria.)

(b) Design Considerations

The following considerations are used to determine the number and location of access approaches on partial control limited access highways.

1. Access approaches must be held to a minimum. The number is limited as follows:
 - Principal arterial: two per side per mile
 - Minor arterial: four per side per mile
 - Collector: six per side per mile, including at-grade intersections
2. Approaches in excess of the number listed above may be allowed as stage construction if approved by the State Design Engineer.
3. Approaches are not allowed for parcels that have reasonable access to other public roads unless a parcel has extensive highway frontage.
4. Relocate or close approaches in areas where sight limitations create undue hazards.
5. Allow only one approach for each parcel, except for very large ownerships, or where terrain features do not allow the property to be served by a single approach. This includes contiguous parcels under a single ownership.
6. Where possible, locate a single approach to serve two or more parcels.
7. The approved design is to provide for future development of frontage roads that will eliminate an excessive number of approaches.

- Local land use planning
- Current and potential land use
- Predicted growth rate
- Economic analysis

(c) **Exceptions**

Where modified control is to be established, developed commercial areas may be excepted from control when all or most of the abutting property has been developed to the extent that few, if any, additional commercial approaches will be needed with full development of the area. Contact the HQ Access and Hearings Section when considering this option. If this exception is within the limits of access control requirements, an approved access deviation is required.

(3) Intersections

At an intersection on a modified control limited access highway, access control will be established and acquired along the crossroad for a minimum distance of 130 feet:

- Measured from the centerline of a two-lane highway (see Exhibit 530-3b).
- Measured from the centerline of the nearest directional roadway of a four-lane highway (see Exhibit 530-3b).
- Measured from the outside edge of the circulating roadway of a roundabout (see Exhibit 530-3a).

Approaches are allowed within this area only when there is no reasonable alternative. An approved access deviation is required for any access that has been allowed to remain within the first 130 feet.

(4) Access Approach

The number and location of approaches on a highway with modified control must be carefully planned to provide a safe and efficient highway compatible with present and potential land use.

(a) **Approach Types**

Modified control limited access highways allow at-grade intersections with selected public roads and with private approaches using Type A, B, C, D, and F approaches. (See Chapter 520 for definitions of the approach types.)

The type of approach provided for each parcel is based on present and potential land use and an evaluation of the following criteria:

- Local comprehensive plans, zoning, and land use ordinances.
- Property covenants and agreements.
- City or county ordinances.
- The highest and best use of the property.
- The highest and best use of adjoining lands.
- A change in use by merger of adjoining ownerships.
- All other factors bearing upon proper land use of the parcel.

(b) Design Considerations

The following items are used to determine the number and location of approaches:

1. Parcels that have access to another public road or street are not normally allowed direct access to the highway.
2. Relocate or close approaches located in areas where sight limitations create undue hazards.
3. Hold the number of access approaches to a minimum. Access approaches are limited to one approach for each parcel of land or where adjoining parcels are under one contiguous ownership.
4. Encourage joint use of access approaches where similar use of land allows.
5. Additional approaches may be allowed for future development consistent with local zoning. Once limited access has been acquired, this will require a value determination process (see 530.10).

Close existing access approaches not meeting the above.

(5) Location of Utilities, Bus Stops, and Mailboxes**(a) Utilities**

Connecting utility lines are allowed along the outer right of way line between intermittent frontage roads. (See the *Utilities Accommodation Policy* regarding location of and access to utilities.)

(b) Bus Stops

Bus stops and pedestrian crossings are allowed as follows:

- In rural areas, bus stops and pedestrian crossings are subject to the same restrictions as in 530.04(5) and (6).
- In urban areas, bus stops for both commercial carriers and school buses are allowed. (See Chapter 1430 for requirements.)

(c) Mailboxes

Locate mailboxes adjacent to or opposite all authorized approaches as follows:

- On a four-lane highway only on the side of the highway on which the deeded approach is provided.
- On a two-lane highway on the side of the highway that is on the right in the direction of the mail delivery.

Where mailboxes are allowed, a mailbox turnout is recommended to allow mail delivery vehicles to stop clear of the through traffic lanes. (See Chapter 1600 for additional information concerning mailbox locations and turnouts.)

(6) Pedestrian and Bicycle Traffic and Paths

Pedestrians and bicyclists are allowed, consistent with “Rules of the Road” (RCW 46.61), on modified control limited access highways except where unusual safety considerations support prohibition. Information pertaining to such prohibitions is available from the Traffic Office of the HQ Maintenance and Operations Division.

Where paths are allowed, they must be documented in the right of way and limited access plan. The plan shows the location of the path and where the path crosses limited access, and it provides movement notes (see 530.10(1)).

530.06 Access Approaches

(1) General

Access approaches may be allowed on limited access highways, consistent with the requirements outlined in 530.03, 530.04, and 530.05.

For additional information pertaining to approaches, refer to Chapters 1320 (roundabouts), 1340 (approach design templates), and 510 (right of way), and the *Plans Preparation Manual*.

(2) Definitions

The widths for the approach types are negotiated, and only the negotiated widths are shown on the right of way and limited access plan. (See Chapter 520 for definitions of the approach types.)

530.07 Frontage Roads

Local agency approval is required for any planned frontage roads, county roads, city streets, or cul-de-sacs. The local agency must also agree in writing to accept and maintain the new section as a county road or city street.

(1) General

Frontage roads are provided in conjunction with limited access highways to:

- Limit access to the main line.
- Provide access to abutting land ownerships.
- Restore the continuity of the local street or roadway system.

Refer to Chapter 1210 for frontage road general policy and Chapter 300 for required documentation.

By agreement under which the state is reimbursed for all costs involved, frontage roads that are not the responsibility of the state may be built by the state upon the request of a local political subdivision, a private agency, or an individual.

(2) County Road and City Street

To connect roads or streets that have been closed off by the highway, short sections of county roads or city streets that are not adjacent to the highway may be constructed if they will serve the same purpose as, and cost less than, a frontage road.

(3) *Cul-de-sacs*

For a frontage road or local street bearing substantial traffic that is terminated or closed at one end, provide a cul-de-sac (or other street or roadway consistent with local policy or practice) that is sufficient to allow vehicles to turn around without encroachment on private property.

530.08 Turnbacks

When WSDOT transfers jurisdiction of operating right of way to a city, town, or county, a turnback agreement is required. (See the *Agreements Manual* for turnback procedures.)

Locate the turnback limits at points of logical termination. This will allow WSDOT to retain an adequate amount of right of way for maintenance of the highway and for other operational functions.

In areas where limited access rights have been acquired from the abutting property owners, the limited access rights will continue to be required for highway purposes; therefore, the limited access rights will not be included as part of a turnback agreement.

When a signalized intersection is in the area of a turnback, locate the turnback limit outside the detector loops if WSDOT is continuing the ownership, operation, and maintenance of the signal system. For a roundabout, locate the turnback limit at the back of the raised approach splitter island if WSDOT is continuing the ownership, operation, and maintenance of the roundabout.

530.09 Adjacent Railroads

(1) *General*

A limited access highway and a railroad are considered adjacent when they have a common right of way border with no other property separating them. The allowed approaches only apply to adjacent railroad property that is directly used for current railroad operation.

(2) *Requirements*

It is in the public's interest to provide access to the railroad right of way, from limited access highways, for maintenance of the railroad and the utilities located on the railroad right of way where other access is not feasible. This applies to both new highways and to existing highways where limited access has been acquired.

Direct access is allowed where local roads are infrequent or there are few highway-railroad crossings from which trail-type access for maintenance purposes is feasible, and where unique topography or other unusual conditions lead to its use.

To provide direct approaches for access to railroad right of way, all of the following conditions must be met:

- A maximum of one approach is allowed for every 2 miles of highway.
- The approach must not adversely affect the design, construction, stability, traffic safety, or operation of the highway.

- Except where the railroad is located in the median area, the approach is to be accomplished in a legal manner by right turns only, to and from the roadway nearest the railroad. Median crossing is not allowed.
- The approach is secured by a locked gate under arrangements satisfactory to the department. (See the Definitions section in Chapter 520 for Approach Type C, and Chapter 550.)
- The parking of any vehicles or railroad equipment is prohibited within limited access highway right of way.
- A special emergency maintenance permit must be obtained for periods of intensive railroad maintenance.
- The approach must be closed if the railroad operation ceases.
- Approaches are limited to use by the railroad company unless specific provisions for other use are shown on the right of way and limited access plan and included in the right of way negotiations.

(3) Restrictions

Direct access from the highway is considered unnecessary and is not allowed where:

- There are local roads adjacent to or crossing the railroad.
- A trail-type road can be provided by the railroad between crossroads.
- The limited access highway is paralleled by a frontage road adjacent to the railroad.
- No highway previously existed adjacent to the railroad.

530.10 Modifications to Limited Access Highways

(1) General

Modifications to limited access highways can only be made by the application of current design requirements and with the approval of the Environmental and Engineering Programs Director (or designee) and FHWA (when appropriate).

Any change is a modification to limited access; for example, constructing new fence openings, closing existing fence openings, adding trails that cross into and out of the right of way, and widening existing approaches. The right of way and limited access plan must be revised and, if private approaches are involved, deeds must be redone.

Any changes proposed on Interstate limited access facilities must include environmental documentation in the request. Contact the HQ Access and Hearings Section for assistance.

Consider the following factors when evaluating a request for modification of a limited access highway:

- Existing level of control on the highway
- Functional classification and importance of the highway
- Percentage of truck traffic
- Highway operations
- Present or future land use
- Environment or aesthetics
- Economic considerations
- Safety considerations

Evaluate all revisions to limited access highways to determine if access hearings are required.

For requirements to be met for selected modifications to full control limited access highways such as the Interstate System and multilane state highways, see Chapter 550, Interchange Justification Report.

(2) Modifications for Private Access Approaches

(a) Requirements

Examples of access modifications requested by abutting property owners include additional road approaches, changes in the allowed use, or additional users of existing road approaches.

Plan revisions that provide for additional access to abutting properties after WSDOT has purchased the access rights are discouraged. However, these revisions may be considered if all of the following can be established:

- There are no other reasonable alternatives.
- The efficiency and safety of the highway will not be adversely impacted.
- The existing situation causes extreme hardship on the owner(s).
- The revision is consistent with the limited access highway requirements.

(b) Procedures

The region initiates a preliminary engineering review of the requested modification to or break in limited access. This preliminary review will be conducted with the HQ Access and Hearings Section to determine whether conceptual approval can be granted for the request. If conceptual approval can be granted, then:

- The region initiates an engineering review of the requested modification.
- The region prepares and submits to the HQ Right of Way Plans Section a preliminary right of way and limited access plan revision, together with a recommendation for approval by the Environmental and Engineering Programs Director. When federal-aid funds are involved in any phase of the project, the proposed modification will be sent to FHWA for its review and approval.
- The recommendation will include an item-by-item analysis of the factors listed in 530.10(1) and 530.10(2)(a).

(c) Valuation Determination

Upon preliminary approval, region Real Estate Services prepares an appraisal for the value of the access change using a before and after appraisal.

- The appraisal follows the requirements set forth in the *Right of Way Manual*.
- The appraisal is reviewed by HQ Real Estate Services. If the appraisal data does not support a value of \$1,500 or more, a minimum value of \$1,500 is used.
- The appraisal package is sent to HQ Real Estate Services for review and approval.
- If federal-aid funds were involved in purchasing access control, HQ Real Estate Services will send a copy of the appraisal package to FHWA for its review and approval.

540.05 Managed Access Highway Classes

The principal objective of the managed access classification system is to maintain the safety and capacity of existing highways. This is accomplished by establishing access management criteria, which are to be adhered to in the planning and regional approval of access connections to the state highway system.

The classification system for state managed access highways consists of five classes. The classes are organized from Class 1, the most restrictive class for higher speeds and volumes, to Class 5, the least restrictive class for lower speeds and volumes. In general, most state highways outside the incorporated limits of a city or town have been designated as Class 1 or Class 2, with only the most urban and lowest-speed state highways within an incorporated town or city designated as Class 5. Exhibit 540-2 shows the five classes of highways, with a brief description of each class. WSDOT keeps a record of the assigned managed access classifications, by state route and milepost, in the Access Control Tracking System database:

 www.wsdot.wa.gov/design/accessandhearings

One of the goals of state law is to restrict or keep access connections to a minimum in order to help preserve the safety, operation, and functional integrity of the state highway. On Class 1 highways, mobility is the primary function, while on Class 5 highways, access needs have priority over mobility needs. Class 2 highways also favor mobility, while Class 3 and Class 4 highways generally achieve a balance between mobility and access.

The most notable distinction between the five highway classes is the minimum spacing requirements of access connections. Minimum distances between access points on the same side of the highway are shown in Exhibit 540-2.

In all five highway classes, access connections are to be located and designed to minimize interference with transit facilities and high-occupancy vehicle (HOV) facilities on state highways where such facilities exist or are proposed in state, regional, metropolitan, or local transportation plans. In these cases, if reasonable access is available to the local road/street system, access is to be provided to the local road/street system rather than directly to the state highway. Following are the functional characteristics and the legal requirements for each class.

(1) Class 1

(a) Functional Characteristics

Class 1 highways provide for high-speed and/or high-volume traffic movements for interstate, interregional, and intercity (and some intracity) travel needs. Service to abutting land is subordinate to providing service to major traffic movements.

Highways in Class 1 are typically distinguished by a highly-controlled, limited number of (public and private) access points, restrictive medians with limited median openings on multilane facilities, and infrequent traffic signals.

(b) Legal Requirements

1. It is the intent that Class 1 highways be designed to have a posted speed limit of 50 to 65 mph. Intersecting streets, roads, and highways are planned with a minimum spacing of 1 mile. Spacing of ½ mile may be allowed, but only when no reasonable alternative access exists.

2. Private access connections to the state highway are not allowed except where the property has no other reasonable access to the local road/street system. When a private access connection must be provided, the following conditions apply:
 - The access connection continues until such time other reasonable access to a highway with a less restrictive access control class or access to the local road/street system becomes available and is allowed.
 - The minimum distance to another (public or private) access point is 1320 feet along the same side of the highway. Nonconforming access connection permits may be issued to provide access connections to parcels whose highway frontage, topography, or location otherwise precludes issuance of a conforming access connection permit; however, variance permits are not allowed.
 - No more than one access connection may be provided to an individual parcel or to contiguous parcels under the same ownership.
 - All private access connections are for right turns only on multilane facilities. Where special conditions apply, justify the exception in a traffic analysis in the access connection permit application that is signed and sealed by a qualified professional engineer who is registered in accordance with RCW 18.43.
 - Additional access connections to the state highway are not allowed for newly created parcels resulting from property divisions. All access for these parcels must be provided by an internal road/street network. Access to the state highway will be at existing permitted locations or revised locations.
3. Restrictive medians are provided on multilane facilities to separate opposing traffic movements and to prevent unauthorized turning movements.

(2) Class 2

(a) Functional Characteristics

Class 2 highways provide for medium-to-high-speed and medium-to-high-volume traffic movements over medium and long distances for interregional, intercity, and intracity travel needs. Direct access service to abutting land is subordinate to providing service to traffic movements.

Highways in Class 2 are typically distinguished by existing or planned restrictive medians on multilane facilities and by large minimum distances between (public and private) access points.

(b) Legal Requirements

1. It is the intent that Class 2 highways be designed to have a posted speed limit of 35 to 50 mph in urbanized areas and 45 to 55 mph in rural areas. Intersecting streets, roads, and highways are planned with a minimum spacing of ½ mile. Less than ½-mile intersection spacing may be allowed, but only when no reasonable alternative access exists.

In urban areas and developing areas where higher volumes are present or growth that will require signalization is expected in the foreseeable future, it is imperative that the location of any public access point be planned

- carefully to ensure adequate signal progression. The addition of all new public or private access points that might require signalization will require an engineering analysis that is signed and sealed by a qualified professional engineer who is registered in accordance with RCW 18.43.
2. Private access connections to the state highway system are allowed only where the property has no other reasonable access to the local road/street system or where access to the local road/street system will cause unacceptable traffic operational conditions or safety concerns on that system. When a private access connection must be provided, the following conditions apply:
 - The access connection continues until such time other reasonable access to a highway with a less restrictive access control class or acceptable access to the local road/street system becomes available and is allowed.
 - The minimum distance to another (public or private) access point is 660 feet on the same side of the highway. Nonconforming access connection permits may be issued to provide access to parcels whose highway frontage, topography, or location precludes issuance of a conforming access connection permit.
 - Only one access connection is allowed for an individual parcel or to contiguous parcels under the same ownership. This applies unless the highway frontage exceeds 1320 feet and it can be shown that the additional access connection will not adversely affect the desired function of the state highway in accordance with the assigned managed access Class 2 or the safety or operation of the state highway.
 - Variance permits may be allowed if there are special conditions and the exception can be justified to the satisfaction of the department by a traffic analysis in the access connection permit application that is signed and sealed by a qualified professional engineer who is registered in accordance with RCW 18.43.
 - All private access connections are for right turns only on multilane facilities. This applies unless there are special conditions and the exception can be justified to the satisfaction of the department by a traffic analysis in the access connection permit application that is signed and sealed by a qualified professional engineer who is registered in accordance with RCW 18.43 and only if left-turn channelization is provided.
 - Additional access connections to the state highway are not allowed for newly created parcels that result from property divisions. All access for these parcels must be provided by an internal road/street network. Access to the state highway will be at existing permitted locations or at revised locations.
 3. On multilane facilities, restrictive medians are provided to separate opposing traffic movements and to prevent unauthorized turning movements. However, a nonrestrictive median or a two-way left-turn lane may be used where special conditions exist and main line volumes are below 20,000 average daily traffic (ADT).

(3) Class 3

(a) Functional Characteristics

Class 3 highways provide for moderate travel speeds and moderate traffic volumes for medium and short travel distances for intercity, intracity, and intercommunity travel needs. There is a reasonable balance between access and mobility needs for highways in this class. This class is to be used primarily where the existing level of development of the adjoining land is less intensive than maximum buildout and where the probability of significant land use change and increased traffic demand is high.

Highways in Class 3 are typically distinguished by planned restrictive medians on multilane facilities and by meeting minimum distances between (public and private) access points. Two-way left-turn lanes may be used where justified and main line traffic volumes are below 25,000 ADT. Development of properties with internal road/street networks and joint access connections is encouraged.

(b) Legal Requirements

1. It is the intent that Class 3 highways be designed to have a posted speed limit of 30 to 40 mph in urbanized areas and 45 to 55 mph in rural areas. In rural areas, intersecting streets, roads, and highways are planned with a minimum spacing of ½ mile. Less than ½-mile intersection spacing may be allowed, but only when no reasonable alternative access exists.

In urban areas and developing areas where higher volumes are present or growth that will require signalization is expected in the foreseeable future, it is imperative that the location of any public access point be planned carefully to ensure adequate signal progression. Where feasible, major intersecting roadways that might ultimately require signalization are planned with a minimum of ½-mile spacing. The addition of all new public or private access points that may require signalization will require an engineering analysis that is signed and sealed by a qualified professional engineer who is registered in accordance with RCW 18.43.

2. Private Access Connections
 - No more than one access connection may be provided to an individual parcel or to contiguous parcels under the same ownership. This applies unless it can be shown that additional access connections will not adversely affect the desired function of the state highway in accordance with the assigned managed access Class 3 and will not adversely affect the safety or operation of the state highway.
 - The minimum distance to another (public or private) access point is 330 feet on the same side of the highway. Nonconforming access connection permits may be issued to provide access to parcels whose highway frontage, topography, or location precludes issuance of a conforming access connection permit.
 - Variance permits may be allowed if there are special conditions and the exception can be justified to the satisfaction of the department by a traffic analysis in the access connection permit application that is signed and sealed by a qualified professional engineer who is registered in accordance with RCW 18.43.

(3) Variance Access Connection Permit

Variance access connection is a special nonconforming or additional access connection permit issued for long-term use where future local road/street system access is not foreseeable:

- For location and spacing not meeting requirements or for an access connection that exceeds the number allowed for the class.
- After an engineering study demonstrates, to the satisfaction of the department, that the access connection will not adversely affect the safety, maintenance, or operation of the highway in accordance with its assigned managed access class.

In such instances, the permit is to be noted as being a variance access connection permit and may contain the following specific restrictions and provisions:

- Limits on the maximum vehicular use of the access connection.
- The properties to be served by the access connection.
- Other conditions as necessary to carry out the provisions of RCW 47.50.

This permit will remain valid until modified or revoked by the permitting authority unless an upgraded permit is required due to changes in property site use (see 540.09(1)).

A variance access connection permit must not be issued for an access connection that does not conform to minimum corner clearance requirements (see 540.06).

(4) Design Exceptions and Deviations

(a) Outside Incorporated City Limits

A deviation request will be required for nonconforming access connections if corner clearance criteria are not met. If a deviation is needed, the HQ Design Office is to be involved early in the process.

A Design Exception (DE) may be allowed for a single-family residence if the corner clearance criteria are not met. Such an access will be outside the corner radius and as close as feasible to the property line farthest away from the intersection. If two or more residences are served by the same driveway not meeting the corner clearance criteria, then a deviation request will be required.

For WSDOT projects, a short memo is retained in the Design Documentation Package (DDP) stating that the approved nonconforming permit satisfies the requirement of the DE. The DE is recorded in the Design Variance Inventory System (DVIS). Any deviations will be included in the DDP as well.

For non-WSDOT projects, the region Development Services Office or Local Programs Office is responsible for entering DEs into the DVIS.

(b) Within Incorporated Cities

In accordance with RCW 35.78.030 and RCW 47.50, incorporated cities and towns have jurisdiction over access permitting on streets designated as state highways. Accesses located within incorporated cities and towns are regulated by the city or town and no deviation by WSDOT will be required. Document decisions made on these accesses in the DDP.

540.10 Other Considerations

(1) Changes in Property Site Use With Permitted Access Connection

The access connection permit is issued to the permit holder for a particular type of land use generating specific projected traffic volumes at the final stage of proposed development. Any changes made in the use, intensity of development, type of traffic, or traffic flow require the permit holder, an assignee, or the property owner to contact the department to determine whether further analysis is needed because the change is significant and will require a new permit and modifications to the access connection (WAC 468-51-110).

A significant change is one that will cause a change in the category of the access connection permit or one that causes an operational, safety, or maintenance problem on the state highway system based on objective engineering criteria or available collision data. Such data will be provided to the property owner and/or permit holder and tenant upon written request (WAC 468-51-110).

(2) Existing Access Connections

(a) Closure of Grandfathered Access Connections

Any access connections that were in existence and in active use on July 1, 1990, are grandfathered.

The grandfathered access connection may continue unless:

- There are changes from the 1990 AWDVTE.
- There are changes from the 1990 established use.
- The department determines that the access connection does not provide minimum acceptable levels of highway safety and mobility based on collision and/or traffic data or accepted traffic engineering criteria, a copy of which must be provided to the property owner, permit holder, and/or tenant upon written request (WAC 468-51-130).

(b) Department Construction Projects

1. Notification

The department must notify affected property owners, permit holders, business owners, and emergency services in writing, when appropriate, whenever the department's work program requires the modification, relocation, or replacement of its access connections. In addition to written notification, the department will facilitate, when appropriate, a process that may include, but is not limited to, public notices, meetings, or hearings, as well as individual meetings.

2. Modification Considerations

When the number, location, or design of existing access connections to the state highway is being modified by a department construction project, the resulting modified access connections must provide the same general functionality for the existing property use as they did before the modification, taking into consideration the existing site design, normal vehicle types, and traffic circulation requirements. These are evaluated on an individual basis.

Include the Structural Capacity Report in the Design Documentation Package (DDP).

The considerations used to evaluate the structural capacity of a bridge are as follows:

1. On National Highway System (NHS) routes (including Interstate routes):
 - The operating load rating is at least 36 tons (which is equal to HS-20).
 - The bridge is not permanently posted for legal weight vehicles.
 - The bridge is not permanently restricted for vehicles requiring overweight permits.
2. On non-NHS routes:
 - The bridge is not permanently posted for legal weight vehicles.
 - The bridge is not permanently restricted for vehicles requiring overweight permits.

(2) Bridge Widths for Structures

(a) New Structures

Full design level widths are provided on all new structures (see Chapter 1140). All structures on city or county routes crossing over a state highway must conform to the *Local Agency Guidelines*. Use local city or county adopted and applied criteria when their minimum width exceeds state criteria.

(b) Existing Structures

For guidance on existing structures, see the design matrices in Chapter 1100.

(3) Horizontal Clearance

Horizontal clearance for structures is the distance from the edge of the traveled way to bridge piers and abutments, traffic barrier ends, or bridge end embankment slopes. Minimum distances for this clearance vary depending on the type of structure. (See Chapters 1600 and 1610 and the *Bridge Design Manual* for guidance on horizontal clearance.)

For structures involving railroads, contact the HQ Design Office Railroad Liaison.

(4) Medians

For multilane highways, the minimum median widths for new bridges are as shown in Chapters 1130 and 1140. Evaluate the need for an opening versus spanning or shielding the opening (examples: decking, netting, or railing treatments) when the open median area between new bridges is 26 feet or less.

The preferred treatment, when cost-effective, is to provide a new single structure that spans the area between the roadways. When this is impracticable, consider widening the two bridges on the median sides to reduce the open area to 6 inches. When neither option is practicable, consider installing netting or other elements to enclose the area between the bridges. An open area between structures may be required for bridge inspection. Coordinate with the Bridge and Structures and Maintenance offices. Document this evaluation in the Design Documentation Package.

(5) Vertical Clearance

Vertical clearance is the critical height under a structure that will accommodate vehicular and rail traffic based on its design characteristics. This height is the least height available from the lower roadway surface (including usable shoulders) or the plane of the top of the rails to the bottom of the bridge. Usable shoulders are the design shoulders for the roadway and do not include paved widened areas that may exist under the structure.

In addition to the following vertical clearance guidance, consider whether the corridor experiences overheight loads. Consider a vertical clearance such that it will not create a new “low point” in the corridor.

(a) Vertical Falsework Clearance for Bridges Over Highways

Construction of new bridges and the reconstruction or widening of existing structures often requires the erection of falsework across the traveled way of a highway. The erection of this falsework can reduce the vertical clearance for vehicles to pass under the work area. The potential for collisions to occur by hitting this lower construction stage falsework is increased.

1. On all routes that require a 16-foot-6-inch vertical clearance, maintain the 16-foot-6-inch clearance for falsework vertical clearance.
 - On structures that currently have less than a 16-foot-6-inch vertical clearance for the falsework envelope, maintain existing clearance.
 - On new structures, maintain the falsework vertical clearance at least to those of the minimum vertical clearances referenced below.
2. Any variance from the above must be approved by the Regional Administrator or designee in writing and made a part of the Project File.

(b) Minimum Clearance for New Structures

For new structures, the minimum vertical clearances are as follows:

1. Bridge Over a Roadway

The minimum vertical clearance for a bridge over a roadway is 16.5 feet.

2. Bridge Over a Railroad Track

The minimum vertical clearance for a bridge over a railroad track is 23.5 feet (see Exhibit 720-2). A lesser clearance may be negotiated with the railroad company based on certain operational characteristics of the rail line; however, any clearance less than 22.5 feet requires the approval of the Washington State Utilities and Transportation Commission (WUTC) per WAC 480-60. Vertical clearance is provided for the width of the railroad clearance envelope. Coordinate railroad clearance issues with the HQ Design Office Railroad Liaison.

3. Pedestrian Bridge Over a Roadway

The minimum vertical clearance for a pedestrian bridge over a roadway is 17.5 feet.

Project Type	Vertical Clearance ^[8]	Documentation Requirement (see notes)
Interstate and Other Freeways^[1]		
New Bridge	> 16.5 ft	[2]
Widening Over or Under Existing Bridge	> 16 ft	[2]
	< 16 ft	[4]
Resurfacing Under Existing Bridge	> 16 ft	[2]
	< 16 ft	[4]
Other With No Change to Vertical Clearance	> 14.5 ft	[3]
	< 14.5 ft	[4]
Nonfreeway Routes		
New Bridge	> 16.5 ft	[2]
Widening Over or Under Existing Bridge	> 15.5 ft	[2]
	< 15.5 ft	[4]
Resurfacing Under Existing Bridge	> 15.5 ft	[2]
	< 15.5 ft	[4]
Other With No Change to Vertical Clearance	> 14.5 ft	[3]
	< 14.5 ft	[4]
Bridge Over Railroad Tracks^[7]		
New Bridge	> 23.5 ft	[2]
	< 23.5 ft	[4][5]
Existing Bridge	> 22.5 ft	[2]
	< 22.5 ft	[4][5]
Pedestrian Bridge Over Roadway		
New Bridge	> 17.5 ft	[2]
Existing Bridge	17.5 ft	[6]
Notes: [1] Applies to all bridge vertical clearances over highways and under highways at interchanges. [2] No documentation required. [3] Document to Design Documentation Package. [4] Approved deviation required. [5] Requires written agreement between railroad company and WSDOT and approval via petition from the WUTC. [6] Maintain 17.5-ft clearance. [7] Coordinate railroad clearance with the HQ Design Office Railroad Liaison. [8] See 720.04(5).		

Bridge Vertical Clearances

Exhibit 720-1

(c) Minimum Clearance for Existing Structures

The criteria used to evaluate the vertical clearance for existing structures depend on the work being done on or under that structure. When evaluating an existing structure on the Interstate System, see 720.04(5)(e), Coordination. This guidance applies to bridge clearances over state highways and under state highways at interchanges. For state highways over local roads and streets, city or county vertical clearance requirements may be used as minimum design criteria. (See Exhibit 720-1 for bridge vertical clearances.)

1. Bridge Over a Roadway

For a project that will widen an existing structure over a highway or where the highway will be widened under an existing structure, the vertical clearance can be as little as 16.0 feet on the Interstate System or other freeways or 15.5 feet on nonfreeway routes. An approved deviation is required for clearance less than 16.0 feet on Interstate routes or other freeways and 15.5 feet on nonfreeway routes.

For a planned resurfacing of the highway under an existing bridge, if the clearance will be less than 16.0 feet on the Interstate System or other freeways and 15.5 feet on nonfreeway routes, evaluate the following options and include in a deviation request:

- Pavement removal and replacement.
- Roadway excavation and reconstruction to lower the roadway profile.
- Providing a new bridge with the required vertical clearance.

Reducing roadway paving and surfacing thickness under the bridge to achieve the minimum vertical clearance can cause accelerated deterioration of the highway and is not recommended. Elimination of the planned resurfacing in the immediate area of the bridge might be a short-term solution if recommended by the Region Materials Engineer (RME). Solutions that include milling the existing surface followed by overlay or inlay must be approved by the RME to ensure adequate pavement structure is provided.

For other projects that include an existing bridge where no widening is proposed on or under the bridge, and the project does not affect vertical clearance, the clearance can be as little as 14.5 feet. For these projects, document the clearance in the Design Documentation Package. For an existing bridge with less than a 14.5-foot vertical clearance, an approved deviation request is required.

2. Bridge Over a Railroad Track

For an existing structure over a railroad track, the vertical clearance can be as little as 22.5 feet. A lesser clearance can be used with the agreement of the railroad company and the approval of the Washington State Utilities and Transportation Commission. Coordinate railroad clearance issues with the HQ Design Office Railroad Liaison.

(8) Bridge Approach Slab

Bridge approach slabs are reinforced concrete pavement installed across the full width of the bridge ends. They provide a stable transition from normal roadway cross section to the bridge ends, and they compensate for differential expansion and contraction of the bridge and the roadway.

Bridge approach slabs are provided on all new bridges. If an existing bridge is being widened and it has an approach slab, slabs are required on the widenings. The region, with the concurrence of the State Geotechnical Engineer and the State Bridge Engineer, may decide to omit bridge approach slabs.

(9) Traffic Barrier End Treatment

Plans for new bridge construction and bridge traffic barrier modifications include provisions for the connection of bridge traffic barriers to the longitudinal barrier approaching and departing the bridge. Indicate the preferred longitudinal barrier type and connection during the review of the bridge preliminary plan.

(10) Bridge End Embankments

The design of embankment slopes at bridge ends depends on several factors. The width of the embankment is determined not only by the width of the roadway, but also by the presence of traffic barriers, curbs, and sidewalks, all of which create the need for additional widening. Examples of the additional widening required for these conditions are shown in the *Standard Plans*.

The end slope is determined by combining the recommendations of several technical experts within WSDOT. Exhibit 720-3 illustrates the factors taken into consideration and the experts involved in the process.

(11) Bridge Slope Protection

Slope protection provides a protective and aesthetic surface for exposed slopes under bridges. Slope protection is normally provided under:

- Structures over state highways.
- Structures within an interchange.
- Structures over other public roads unless requested otherwise by the public agency.
- Railroad overcrossings if requested by the railroad.

Slope protection is usually not provided under pedestrian structures.

The type of slope protection is selected at the bridge preliminary plan stage. Typical slope protection types are concrete slope protection, semi-open concrete masonry, and rubble stone.

(12) Slope Protection at Watercrossings

The HQ Hydraulics Section determines the slope protection requirements for structures that cross waterways. The type, limits, and quantity of slope protection are shown on the bridge preliminary plan.

(13) Protective Screening for Highway Structures

The Washington State Patrol (WSP) classifies the throwing of an object from a highway structure as an assault, not an accident. Therefore, records of these assaults are not contained in WSDOT's collision databases. Contact the RME's office and the WSP for the history of reported incidents.

Protective screening might reduce the number of incidents, but will not stop a determined individual. Enforcement provides the most effective deterrent.

Installation of protective screening is analyzed on a case-by-case basis at the following locations:

- On existing structures where there is a history of multiple incidents of objects being dropped or thrown and where enforcement has not changed the situation.
- On new structures near schools, playgrounds, or areas frequently used by children not accompanied by adults.
- In urban areas on new structures used by pedestrians where surveillance by local law enforcement personnel is not likely.
- On new structures with walkways where experience on similar structures within a 1-mile radius indicates a need.
- On private property structures, such as buildings or power stations, that are subject to damage.

In most cases, the installation of a protective screen on a new structure can be postponed until there are indications of need.

Submit all proposals to install protective screening on structures to the State Design Engineer for approval. Contact the HQ Bridge and Structures Office for approval to attach screening to structures and for specific design and mounting details.

720.05 Documentation

For the list of documents required to be preserved in the Design Documentation Package and the Project File, see the Design Documentation Checklist:

~www.wsdot.wa.gov/design/projectdev/

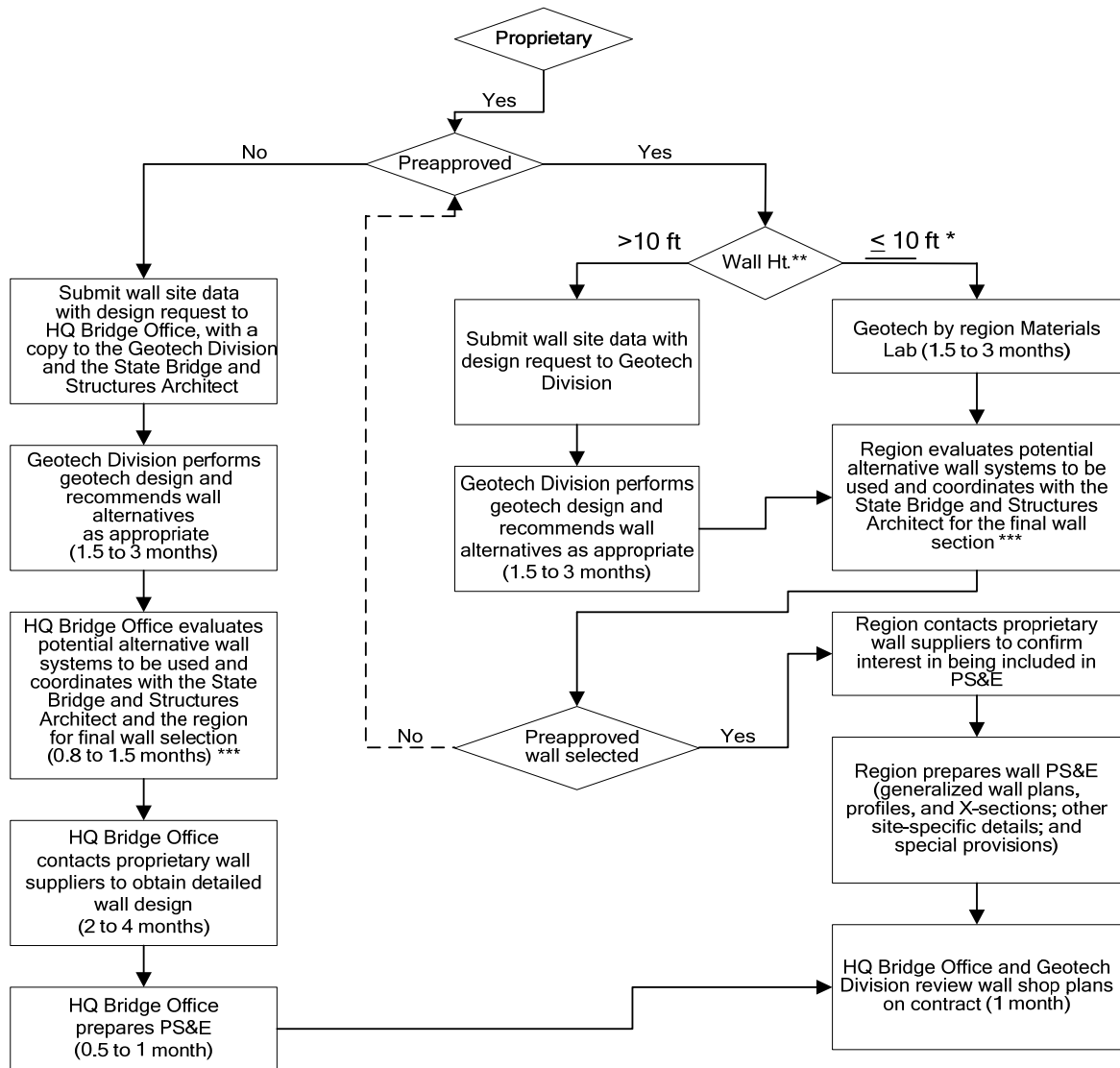

Notes:

“HQ Bridge Office” refers to the WSDOT HQ Bridge and Structures Office.

“Geotech Division” refers to the WSDOT Geotechnical Division at Headquarters.

“State Bridge and Structures Architect” refers to the Architecture Section, HQ Bridge and Structures Office.

Regarding time estimates:

- Assumes no major changes in the wall scope during design.
- Actual times may vary depending on complexity of project.
- Contact appropriate design offices for more accurate estimates of time.

Legend:

Region provides courtesy copy of geotechnical report to Geotechnical Services Division.

*Assumes soft or unstable soil not present and wall does not support other structures.

**The preapproved maximum wall height is generally 33 feet. Some proprietary walls might be less. (Check with the HQ Bridge and Structures Office.)

***If the final wall selected is a different type than assumed, go back through the design process to ensure that all the steps have been taken.

Retaining Wall Design Process: Proprietary

Exhibit 730-13b

800.01	General
800.02	References
800.03	Hydraulic Considerations
800.04	Safety Considerations
800.05	Design Responsibility
800.06	Documentation

800.01 General

Hydraulic design factors can significantly influence the corridor, horizontal alignment, grade, location of interchanges, and necessary appurtenances required to convey water across, along, away from, or to a highway or highway facility. An effective hydraulic design conveys water in the most economical, efficient, and practical manner to ensure reasonable public safety without incurring excessive maintenance costs or appreciably damaging the highway or highway facility, adjacent property, or the total environment.

This chapter is intended to serve as a guide to highway designers so they can identify and consider hydraulic-related factors that impact design. Detailed criteria and methods that govern highway hydraulic design are in the Washington State Department of Transportation (WSDOT) *Hydraulics Manual* and *Highway Runoff Manual*.

Some drainage, flood, and water quality problems can be easily recognized and resolved; others might require extensive investigation before a solution is developed. Specialists experienced in hydrology and hydraulics can contribute substantially to the planning and project definition phases of a highway project by recognizing potentially troublesome locations, making investigations, and recommending practical solutions. Regions may request that the Headquarters (HQ) Hydraulics Section provide assistance regarding hydraulic problems.

Since hydraulic factors can affect the design of a proposed highway or highway facility from its inception, consider these factors at the earliest possible time during the planning phase.

In the project definition phase, begin coordination with all state and local governments and Indian tribes that issue or approve permits for the project.

800.02 References

(1) Design Guidance

Highway Runoff Manual, M 31-16, WSDOT

Hydraulics Manual, M 23-03, WSDOT

Standard Plans for Road, Bridge, and Municipal Construction (Standard Plans), M 21-01, WSDOT

Standard Specifications for Road, Bridge, and Municipal Construction (Standard Specifications), (Amendments and General Special Provisions), M 41-10, WSDOT

Utilities Manual, M 22-87, WSDOT

(2) *Special Criteria*

Special criteria for unique projects are available by request from the HQ Hydraulics Section.

800.03 Hydraulic Considerations

(1) *The Flood Plain*

Encroachment of a highway or highway facility into a flood plain might present significant problems. A thorough investigation includes the following:

- The effect of the design flood on the highway or highway facility and the required protective measures.
- The effect of the highway or highway facility on the upstream and downstream reaches of the stream and the adjacent property.
- Compliance with hydraulic-related environmental concerns and hydraulic aspects of permits from other governmental agencies per Chapters 220 and 230.

Studies and reports published by the Federal Emergency Management Agency (FEMA) and the U.S. Army Corps of Engineers are very useful for flood plain analyses. The HQ Hydraulics Section has access to all available reports and can provide any necessary information to the region.

(2) *Stream Crossings*

When rivers, streams, or surface waters (wetland) are crossed with bridges or culverts (including open-bottom arches and three-sided box culverts), consider:

- Locating the crossing where the stream is most stable.
- Effectively conveying the design flow(s) at the crossing.
- Providing for passage of material transported by the stream.
- The effects of backwater on adjacent property.
- Avoiding large skews at the crossing.
- The effects on the channel and embankment stability upstream and downstream from the crossing.
- Location of confluences with other streams or rivers.
- Fish and wildlife migration.
- Minimizing disturbance to the original streambed.
- Minimizing wetland impact.

For further design details, see the *Hydraulics Manual*.

- Consider stripping, stockpiling, and reapplying topsoil if construction will disturb topsoil. When this is not feasible, amend remaining soil to meet horticultural requirements, reduce compaction, and increase moisture retention.
- Consider design speeds in the selection and location of plants. For example, where traffic speeds are higher, include larger groupings of fewer species in the landscape. (In areas of increased speeds, a motorist's perception of detail along the roadside diminishes.)
- Accommodate existing and proposed utilities.
- When selecting vegetation, consider screening undesirable views, or consider allowing openings to reveal or maintain desirable views.
- Design roadsides, particularly areas under bridges, to reduce potential for homeless encampments. Keep clear lines of sight where this potential exists.

Roadway geometrics will also affect the type and extent of vegetation in specific locations. The maximum allowable diameter of trees within the Design Clear Zone is 4 inches, measured at 6 inches above the ground when the tree has matured. Consider limiting vegetation diameters on the outside of curves beyond the Design Clear Zone. (See the *Roadside Manual* for more information.)

(2) Existing Vegetation

Design and construct within the roadside to retain desirable existing vegetation, reduce impacts on desirable existing vegetation, and restore damaged desirable vegetation where impacts occur. Also:

- Protect desirable existing vegetation wherever possible.
- Delineate trees that are to remain within the construction zone, and provide adequate protection of the root zone (extending from the tree trunk to a minimum of 3 feet beyond the drip line).
- Encourage desirable vegetation by using revegetation techniques to prevent or preclude the establishment of undesirable vegetation. (For more information on vegetation management, see: www.wsdot.wa.gov/maintenance/vegetation/.)
- Limit clearing and grubbing (especially grubbing) to the least area possible.

Selectively remove vegetation to:

- Remove dead and diseased trees when they may be a risk (including those outside the clear zone).
- Maintain clear zone and sight distance.
- Increase solar exposure and reduce collision rates, if analysis shows that removing vegetation will improve safety.
- Open up desirable views.
- Encourage understory development.
- Encourage individual tree growth.
- Prevent plant encroachment on adjacent properties.
- Ensure long-term plant viability.

Refer to the *Roadside Manual* for more information.

(3) Plant Material Selection

Select plants that are not invasive (not having the potential to spread onto roadways, ditches, and adjacent lands).

Base plant material selection on the following:

- Functional needs of the roadside.
- Native species are first priority unless non-native species would be more sustainable (urban areas or sites) or better serve the intended function.
- Maintenance requirements.
- Site analysis and conditions expected after construction.
- Horticultural requirements.
- Plant availability.
- Plant success rates in the field.
- Plant cost.
- Traffic speed.

The *Roadside Manual* provides more detailed guidelines on plant selection, sizing, and location.

(4) Planting Area Preparation

The planting area should be appropriately prepared to achieve successful restoration of vegetation. Soils should be ripped or cultivated to eliminate compaction. Decompaction and the increase of organic content will improve air and water movement through the soil and improve growth and survival of restored plants.

Soil treatments (such as incorporation of soil amendments into the soil layer and surface mulching) will improve the success rate of revegetation after highway construction activities have removed or disturbed the original topsoil. Woody native plants will grow faster and require less weed control through the combined use of compost and bark mulch.

- Use soil amendments based on the soil analysis done for the project. Soil amendments will enhance the soil's moisture-holding capacity. Coordinate soil testing through the Horticulturist or Landscape Architect at the HQ Roadside and Site Development Section.
- Use surface mulches to conserve soil moisture and moderate soil temperatures. Mulches also help keep weeds from competing with desirable plants for water and nutrients, and they provide organic matter and nutrients to the soil.
- Use of inorganic fertilizers should be avoided. If organic fertilizers are used, check with the local Maintenance or Environmental Office or the local jurisdiction for any restrictions on fertilizer use, such as those in well-head protection areas or restricted watershed areas.

- 930.01 General
- 930.02 References
- 930.03 Design Considerations
- 930.04 Documentation

930.01 General

Irrigation provides additional moisture to plants during their establishment (the first 3–5 years) or, in special cases, on a continuing basis. Irrigation is a high-maintenance and high-cost item; use only when absolutely necessary. Permanent irrigation is only used in semiurban and urban character classifications in Treatment Levels 2 and 3. (See the *Roadside Classification Plan* for more information.) Contact the region Landscape Architect or the Headquarters (HQ) Roadside and Site Development Section for assistance with irrigation plans.

930.02 References

(1) Design Guidance

Roadside Classification Plan, M 25-31, WSDOT

Roadside Manual, M 25-30, WSDOT

930.03 Design Considerations

(1) Project Planning Phase

During the project planning phase, make the following determinations:

- (a) Determine whether irrigation is necessary.
 - Analyze soils.
 - Determine local climate conditions and microclimates.
 - Consult with the HQ Horticulturist or region Landscape Architect, or the HQ Roadside and Site Development Section for regions without landscape architectural expertise, for site, soil, and plant recommendations to reduce or eliminate the need for irrigation.
 - Describe where irrigation is needed based on a functional design concept, such as “irrigation is needed to provide green lawn at a safety rest area.”
- (b) Determine the source of water and its availability, rate of flow and pressure, and connection fees.

Sources of water for irrigation use include municipal water systems and water pumped from a well, pond, or stream. When selecting a source of water, consider what permits and agreements may be needed as well as the cost and feasibility of bringing water from the source to the site.
- (c) Determine applicable laws and regulations regarding water and backflow prevention.

(2) *Design and Implementation Phases*

During the design and implementation phases:

- Coordinate with the local water purveyor.
- Select durable, readily available, easy-to-operate, and vandal-resistant irrigation components.
- Proprietary device selections require approval, as specified in the *Plans Preparation Manual*.
- Determine power source and connection fees.
- Consider the need for winterization of the irrigation system to avoid freeze damage to system components.

Use this information to document design decisions for the Project File.

Show the location and type of water source on the irrigation plan.

For more detailed information on irrigation systems and irrigation documentation, see the *Roadside Manual*.

930.04 Documentation

For the list of documents required to be preserved in the Design Documentation Package and the Project File, see the Design Documentation Checklist:

 www.wsdot.wa.gov/Design/projectdev/

- Provide emergency pullouts for disabled vehicles on projects with narrow shoulders.
- Use heavy-vehicle restrictions and provide alternate routes or lane use restrictions.

(c) **Work Zone Safety Management**

- Provide temporary access road approaches for work zone access.
- Use positive protective devices (barrier) for long-term work zones to improve the environment for workers and motorists.
- Install intrusion alarms or vehicle arresting devices.
- Use speed limit reductions when temporary conditions create a need for motorist slow-downs.

(d) **Traffic/Incident Management and Enforcement**

- Provide law enforcement patrols to reduce speeding and aggressive drivers.
- Provide incident response patrols during construction to reduce delays due to collisions in the work zone.
- Include work zone ITS elements in the project or coordinate with TMC to use existing equipment.
- Provide a dedicated tow service to clear incidents.

(7) Public Information (PI) Strategies

(a) **Public Awareness**

One PI strategy is a public awareness campaign using the media, project websites, public meetings, e-mail updates, and mailed brochures. This gives regular road users advance notice of impacts they can expect and time to plan for alternate routes or other options to avoid project impacts. Involve the region or HQ Communications Office in developing and implementing these strategies.

(b) **Driver Information**

In addition to work zone signs, provide driver information using highway advisory radio (HAR) and changeable message signs (existing or portable). Provide additional work zone ITS features that could include traffic cameras or queue detection along with changeable message signs to provide drivers with real time information on delays and traffic incidents. Involve the region TMC in the development and implementation of these strategies. Coordinate freight travel information and restrictions through the Freight Systems Office. Additional information on work zone ITS can be found on the Work Zone Safety web page:

 www.wsdot.wa.gov/safety/workzones/

Work zone strategy development is a fluid process and may be ongoing as project information and design features are developed during the design process. There may be many factors involved with strategy development, and it is necessary to be well organized to make sure all the relative factors are identified and evaluated.

(c) **Pedestrian and Bicycle Information**

Include pedestrian and bicycle access information and alternate routes in the public awareness plans. Pedestrian and bicyclist information signing, including alternate route maps specifically for these road users, could be considered.

1010.07 Capacity Analysis

Work zone congestion and delay is a significant issue for many highway projects. High-volume locations with existing capacity problems will certainly be candidates for further capacity problems when a work zone is in place. Work zones can create many types of roadway restrictions, such as lane closures, shoulder closures, narrowed lanes, closures and detours, and diversions, which all reduce capacity. Even when the construction work does not affect adjacent traffic lanes, slowdowns in the traffic flow are common because these activities can distract a motorist.

All work zone restrictions need to be analyzed to determine the level of impacts. Short-term impacts may only require work hour restrictions; long-term impacts require a detailed capacity analysis of the proposed mitigation strategies to select the best method of maintaining mobility. Include the *Work Zone & Traffic Analysis* in the Project File.

Work zone mobility impacts can have the following effects:

- **Crashes:** Most work zone crashes are congestion-related, usually in the form of rear-end collisions due to traffic queues. Traffic queues beyond the advance warning signs increase the risk of crashes.
- **Driver Frustration:** Drivers expect to travel to their destinations in a timely manner. If delays occur, driver frustration can lead to aggressive or inappropriate driving actions.
- **Constructibility:** Constructing a project efficiently relies on the ability to pursue work operations while maintaining traffic flow. Delays in material delivery, work hour restrictions, and constant installation and removal of traffic control devices all detract from constructibility.
- **Local Road Impacts:** Projects with capacity deficiencies can sometimes cause traffic to divert to local roadways, which may impact the surrounding local roadway system and community. Local roads may have lower geometric criteria than state facilities. Placing additional and new types of traffic on a local road may create new safety concerns, especially when drivers are accustomed to the geometrics associated with state highways.
- **Public Credibility:** Work zone congestion and delay can create poor credibility for WSDOT with drivers and the surrounding community in general.
- **Restricted Access:** Severe congestion can effectively gridlock a road system, preventing access to important route connections, businesses, schools, hospitals, and so on.
- **User Cost Impacts:** Congestion and delay, as well as associated collisions and other impacts, can create significant economic impacts to road users and the surrounding community. Calculate user costs as part of a work zone capacity analysis; the costs may be used to determine liquidated damages.

1020.01	General
1020.02	References
1020.03	Design Components
1020.04	Overhead Installation
1020.05	State Highway Route Numbers
1020.06	Mileposts
1020.07	Guide Sign Plan
1020.08	Documentation

1020.01 General

The Washington State Department of Transportation (WSDOT) uses signing as the primary mechanism for regulating, warning, and guiding traffic. Signing must be in place when any section of highway is open to the motoring public. Each highway project has unique and specific signing requirements. For statewide signing uniformity and continuity, it is sometimes necessary to provide signing beyond the project limits. Design characteristics of the facility determine the size and legend for a sign. As the design speed increases, larger sign sizes are necessary to provide adequate message comprehension time. The MUTCD, the *Traffic Manual*, and the *Sign Fabrication Manual* contain standard sign dimensions, specific legends, and reflective sheeting types for all new signs.

Guide signing provides the motorist with directional information to destinations. This information is always presented in a consistent manner. In some cases, there are specific laws, regulations, and policies governing the content of the messages on these signs. All proposed guide signs for a project require the approval of the region Traffic Engineer. The use of nonstandard signs is strongly discouraged and their use requires the approval of the State Traffic Engineer.

The design matrices in Chapter 1100 identify the design levels for signing on all Preservation and Improvement projects. These levels are indicated in the column “Signing” for Interstate main line and the column “Signing, Delineation, and Illumination” for all other routes.

Review and update existing signing within the limits of all Preservation and Improvement projects as indicated in the matrices. Apply the following criteria when determining whether to replace or modify existing signs:

- Lack of nighttime retroreflectivity
- Substantial damage, vandalism, or deterioration
- Age of signs (seven to ten years old)
- Change in sign use policy
- Improper location
- Message or destination changes necessary to satisfy commitments to public or local agencies
- Substandard mounting height
- Change in jurisdiction (for example, a county road becomes a state route)

Address sign support breakaway features when identified in the “Clear Zone” columns of the matrices. When the “F” (full design level) matrix designation is present, the preceding criteria are still applicable and all existing signing is required to conform to the current policy for reflective sign sheeting requirements. Remove or replace signing not conforming to this policy.

1020.02 References

(1) Federal/State Laws and Codes

23 Code of Federal Regulations (CFR) 655, Traffic Operations

Directive D 32-20, “State Route Mileposts,” WSDOT

Revised Code of Washington (RCW) 47.36, Traffic control devices

(2) Design Guidance

Manual on Uniform Traffic Control Devices for Streets and Highways (MUTCD), 2003 Edition, FHWA, 2003, including the Washington State Modifications to the MUTCD, M 24-01, 2003

Plans Preparation Manual, M 22-31, WSDOT

Sign Fabrication Manual, M 55-05, WSDOT

Standard Plans for Road, Bridge, and Municipal Construction (Standard Plans), M 21-01, WSDOT

Standard Specifications for Road, Bridge, and Municipal Construction (Standard Specifications), M 41-10, WSDOT

Standard Specifications for Structural Supports for Highway Signs, Luminaires, and Traffic Signals, 4th Edition, Washington DC, AASHTO, 2001

Traffic Manual, M 51-02, WSDOT

1020.03 Design Components

(1) Location

The MUTCD contains the guidelines for positioning signs. Check sign locations to ensure the motorist’s view of the sign is not obscured by other roadside appurtenances. Also, determine whether the proposed sign will obstruct the view of other signs or limit the motorist’s sight distance of the roadway. Reposition existing signs, when necessary, to satisfy these visibility requirements. Where possible, locate signs behind existing traffic barriers, on grade separation structures, or where terrain features will minimize their exposure to errant vehicles.

(2) Longitudinal Placement

The MUTCD and the *Traffic Manual* provide guidelines for the longitudinal placement of signs that are dependent on the type of sign. Select a location to fit the existing conditions to provide for visibility and adequate response time. In most cases, signs can be shifted longitudinally to enhance safety without compromising their intended purpose.

(3) Lateral Clearance

The *Standard Plans* and the MUTCD contain minimum requirements for the lateral placement of signs. Where possible, position the signs at the maximum feasible lateral clearance for safety and reduced maintenance costs. Locate large guide signs and motorist information signs beyond the Design Clear Zone (see Chapter 1600) where limited right of way or other physical constraints are not a factor. On steep fill slopes, an errant vehicle is likely to be partially airborne from the slope break near the edge of shoulder to a point 12 feet down the slope. When signs are placed on fill slopes steeper than 6H:1V, locate the support at least 12 feet beyond the slope break.

Use breakaway sign support features, when required, for signs located within the Design Clear Zone and for signs located beyond this zone where there is a possibility they might be struck by an errant vehicle. Breakaway features are not necessary on signposts located behind traffic barriers. Install longitudinal barriers to shield signs without breakaway features within the Design Clear Zone when no other options are available.

Sign bridges and cantilever sign structures have limited span lengths. Locate the vertical components of these structures as far from the traveled way as possible and, where appropriate, install traffic barriers (see Chapter 1610).

Do not locate signposts in the bottom of a ditch or where the posts will straddle the ditch. The preferred location is beyond the ditch or on the ditch backslope (see the *Standard Plans*). In high-fill areas where conditions require placement of a sign behind a traffic barrier, consider adding embankment material to reduce the length of the sign supports.

(4) Sign Heights

For ground-mounted signs installed at the side of the road, provide a mounting height of at least 7 feet, measured from the bottom of the sign to the edge of traveled way. Supplemental plaques, when used, are mounted directly below the primary sign. At these locations, the minimum mounting height of the plaque is 5 feet.

Do not attach supplemental guide signs to the posts below the hinge mechanism or the saw cut notch on multiple-post installations. The location of these hinges or saw cuts on the sign supports are shown in the *Standard Plans*.

A minimum 7-foot vertical height from the bottom of the sign to the ground directly below the sign is necessary for the breakaway features of the sign support to function properly when struck by a vehicle. The minimum mounting height for new signs located behind longitudinal barriers is 7 feet, measured from the bottom of the sign to the edge of traveled way. A lower mounting height of 5 feet may be used when replacing a sign panel on an existing sign assembly located behind the longitudinal barrier. The *Standard Plans* shows typical sign installations.

For ground-mounted signs installed on multiple posts that are a minimum of 12 feet from the edge of traveled way in cut sections, the minimum height clearance between the sign and the ground for the post farther from the edge of traveled way is as follows:

- For slopes 2H:1V and steeper, the minimum height clearance is 2 feet.
- For slopes 3H:1V or flatter, the minimum height clearance is 7 feet.

Signs used to reserve parking for people with disabilities are installed at each designated parking stall and are mounted 7 feet above the surface at the sign location.

(5) Foundations

Foundation details for timber and steel ground-mounted sign supports are shown in the *Standard Plans*, which also contains foundation designs for truss-type sign bridges and cantilever sign structures. Three designs, Types 1, 2, and 3, are shown for each structure.

An investigation of the foundation material is necessary to determine the appropriate foundation design. Use the data obtained from the geotechnical report to select the foundation type.

- The **Type 1** foundation design uses a large concrete shaft and is the preferred installation when the lateral bearing pressure of the soil is 2,500 psf or greater.
- The **Type 2** foundation design has a large rectangular footing design and is an alternative to the Type 1 foundation when the concrete shaft is not suitable.
- The **Type 3** foundation design is used in poorer soil conditions where the lateral bearing pressure of the soil is between 1,500 psf and 2,500 psf.

If a nonstandard foundation or monotube structure design is planned, forward the report to the Headquarters (HQ) Bridge and Structures Office for use in developing a suitable foundation design (see Chapter 610).

(6) Signposts

Ground-mounted signs are installed on either timber posts, laminated wood box posts, or steel posts. The size and number of posts required for a sign installation are based on the height and surface area of the sign, or signs, being supported. Use the information in Exhibits 1020-2, 1020-3, and 1020-4 and the *Standard Plans* to determine the posts required for each installation. Coordinate with the region Maintenance Office concerning signpost installation.

Use steel posts with breakaway supports that are multidirectional if the support is likely to be hit from more than one direction. For any wide flange multiple-steel post installations located within the Design Clear Zone, the total weight of all the posts in a 7-foot-wide path is not to exceed a combined post weight of 34 lbs/foot. Use the Wide Flange Beam Weights table in Exhibit 1020-3 to determine wide flange steel post weights. If the proposed sign configuration does not meet the weight criterion, relocate, resize, or provide barrier protection for the proposed installation.

All signposts are to be designed to 90 mph wind loads. Design features of breakaway supports are shown in the *Standard Plans*. Steel signposts commonly used are: Perforated Square Steel Tube (PSST); Square Steel Tube (SST); Round Pipe (RP); and Wide Flange "H-Beam." Steel posts with Type TP-A, TP-B, PL, PL-T, PL-U, AS, AP, SB-1, and SB-2 bases have multidirectional breakaway features.

1020.04 Overhead Installation

Guidance on the use of overhead sign installations is provided in the MUTCD.

Where possible, mount overhead signs on grade separation structures rather than sign bridges or cantilever supports.

Details for the construction of truss-type sign bridges and cantilever sign supports are shown in the *Standard Plans*.

luminaire A complete lighting unit comprised of a light bulb, wiring, and a housing unit.

luminance The quotient of the luminous flux at an element of the surface surrounding the point and propagated in directions defined by an elementary cone containing the given direction, by the product of the solid angle of the cone and area of the orthogonal projection of the element of the surface on a plane perpendicular to the given direction. The luminous flux may be leaving, passing through, and/or arriving at the surface.

luminous flux The time rate of the flow of light.

maximum uniformity ratio The average light level within the design area divided by the minimum light level within the design area (see Exhibit 1040-25).

maximum veiling luminance ratio The maximum veiling luminance divided by the average luminance over a given design area for an observer traveling parallel to the roadway centerline (see Exhibit 1040-25).

minimum average light level The average of all light intensities within the design area, measured just prior to relamping the system (see Exhibit 1040-25, Note 1).

minimum light level The minimum light intensity of illumination at any single point within the design area measured just prior to relamping the system (see Exhibit 1040-25, Note 1).

mounting height – luminaire The vertical distance between the surface of the design area and the center of the light source of the luminaire. Note: This is not to be confused with pole height (H1), but is the actual distance that the luminaire is located above the roadway edge line.

multimodal connection The point where multiple types of transportation activities occur; for example, where transit buses and van pools drop off or pick up passengers (including passengers with bicycles).

nighttime The period of time from one-half hour after sunset to one-half hour before sunrise and any other time when persons or objects may not be clearly discernable at a distance of 500 feet (RCW 46.04.200).

pedestrian crossing For the purpose of lighting design, the number of pedestrian movements that cross through the design area.

pole height (H1) The vertical distance from the light source to the pole base. This distance is specified in contracts and used by the pole manufacturers to fabricate the light standard.

roadway luminance The light projected from a luminaire that travels toward a given area, represented by a point on the pavement surface, and then back toward the observer, opposite to the direction of travel. The units of roadway luminance are footcandles.

security lighting A minimal amount of lighting used to illuminate areas for public safety or theft reduction. Security lighting for walkways is the lighting of areas where shadows and horizontal and vertical geometry obstruct a pedestrian's view.

Signal Maintenance Management System (SIMMS) A database used for traffic signals, illumination, and Intelligent Transportation Systems (ITS). SIMMS is used to establish an inventory base, enter work reports, print timesheets, and store maintenance records for electrical/electronics systems within WSDOT right of way.

slip base A mechanical base designed to allow the light standard to break away from the fixed foundation when hit by a vehicle traveling at the design speed.

spacing The distance in feet measured on centerline between adjacent luminaires.

transit flyer stop A multimodal connection located within the boundaries of a limited access facility.

transit stop A connection on the highway where the transit bus stops to pick up or drop off passengers.

uniformity ratio The ratio of the minimum average light level on the design area to the minimum light level of the same area (see Exhibit 1040-25).

veiling luminance The stray light produced within the eye by light sources produces a veiling luminance that is superimposed on the retinal image of the objects being observed. This stray light alters the apparent brightness of an object within the visual field and the background against which it is viewed, thereby impairing the ability of the driver to perform visual tasks. Conceptually, veiling luminance is the light that travels directly from the luminaire to the observer's eye.

1040.04 Design Considerations

An illumination system is built from many separate components. The simplest illumination system contains the following:

- A power feed from the local utility company.
- An electrical service cabinet containing a photocell and circuit breaker for each illumination circuit.
- Runs of conduit with associated junction boxes leading to each luminaire.
- Conductors routed from the service cabinet breaker to each luminaire.
- A concrete light standard foundation.
- A light standard with a slip base or a fixed base.
- A luminaire (light) over or near the roadway edge line.

There are design considerations that need to be addressed when performing even the most minimal work on an existing illumination system. An existing electrical system is acceptable for use under the design requirements and National Electric Code (NEC) rules that were in effect at the time of installation. When modifying an existing electrical system, the designer is responsible for bringing the whole system up to current NEC design standards. Retrofitting an existing fixed base light standard with a slip base feature requires the installation of quick disconnect fittings and fuses in the circuit, at the luminaire. The existing conductor configuration for a fixed base luminaire is not acceptable for use on a breakaway (slip base) installation. Existing conductors and components that no longer meet current NEC requirements are to be replaced and the whole circuit is to be designed to current standards. This may mean replacing the whole circuit back to the nearest overcurrent protection device (circuit breaker).

Address the following when modifying an existing illumination system:

- Whether the existing circuit is in compliance with current NEC standards (deficient electrical component).
- Whether existing luminaire system components, such as conductors, conduit, junction boxes, foundation, and pole comply with current standards.
- Whether conductors meet NEC requirements for temperature rating (deficient electrical component).
- Conductor material: aluminum conductors or copper conductors (deficient electrical component).
- The condition and adequacy of the existing conduit running between the luminaire and the nearest junction box (deficient electrical component).
- The condition of the junction box next to the luminaire (deficient electrical component).
- The suitability of the existing foundation to meet current design requirements.
- The suitability of the location to meet current design standards for illumination.
- The location and bolt pattern of the existing foundation to meet current design standards.
- The design life remaining for the existing light standard (deficient electrical component).
- The condition of the existing light standard (deficient electrical component).
- Maintenance personnel assessment of the electrical safety of the installation.

Involve appropriate Headquarters (HQ) and region Traffic Office design personnel early in the process. Ensure potential system deficiencies are reflected in the estimate of work.

Another consideration is the need to maintain illumination during construction. Site preparation, widening, drainage, guardrail installation, or other work can easily impact existing conduit runs or luminaire locations. Also, changed conditions such as merging, weaving, or unusual alignment due to traffic control often require additional temporary illumination. Note: The same lighting requirements apply whether a condition is temporary or permanent.

1040.05 Required Illumination

The design matrices identify the following design levels for illumination on all Preservation and Improvement projects (see Chapter 1100):

- **Basic Design Level:** At the basic design level for minor safety or preservation work, provide slip base features on existing light standards (when in the Design Clear Zone or recovery area) and bring electrical components to current standards. Providing additional lighting or relocating light standards on Preservation projects may be considered spot safety enhancements. When the Illumination column has an EU (evaluate upgrade to full design level), consider providing illumination if it would be beneficial to the specific project, and document accordingly.

For Minor Operational Enhancement projects using the design matrices in Chapter 1110, illumination is not required.

- **Evaluate Upgrade:** Review the age of the equipment as listed in SIMMS and consider replacing components that have reached their design life. Where items will not be upgraded, document why it will not be done. Locate components such that they can be safely accessed from the right of way. Replace poles, foundations, heads, and so on, that have reached their design life. Slip base features should be in accordance with current design standards. Evaluate uniformity in the design areas (see 1040.07(2)). Locations that are illuminated per this section should be brought to full standards or documented regarding why they are not (for example, deferred to another project). Consider additional illumination in accordance with 1040.06, if warranted, or design additional illumination if it is called for in the Project Definition.

When it is necessary to relocate existing light standard foundations, evaluate the entire conduit run serving those light standards and replace deficient components to current (NEC) standards.

- **Full Standards:** For full design level, the illumination specified in this chapter is required when constructing a new system and/or bringing the entire existing system to full standards (such as slip base features, replacement of standard duty junction boxes that are located in paved areas with heavy-duty junction boxes, grounding, conduit, light levels, and uniformity). On existing systems, this includes all components not otherwise affected by the project. Review all conduit runs, not just the one affected by relocating light standards on that run.

Exhibits 1040-1 through 1040-24 show examples of illumination for roadway, transit flyer stops, parking lots, truck weigh stations, tunnels, bridges, work zones, and detour applications. Illumination is required in Exhibits 1040-1 through 1040-10 and 1040-12 through 1040-23, which are further discussed in the remainder of this section.

A minimum of two light standards of standard pole height are required at all design areas, with the exception of ramp terminals and entrance/exit points at minor parking lots.

(1) Freeway Off-Ramps and On-Ramps

Provide the necessary illumination for the design area of all freeway off-ramp gore areas and on-ramp acceleration tapers (see 1040.07(2) and Exhibits 1040-1a, 1b, and 1c).

(2) Freeway Ramp Terminals

Provide the necessary illumination for the design area (see Exhibit 1040-2). Additional illumination is required if the intersection has left-turn channelization or a traffic signal.

(3) Freeway On-Ramps With Ramp Meter Signals

Provide the necessary number of light standards to illuminate freeway on-ramps with ramp meters, from the beginning of the on-ramp to the ramp meter stop bar. When there is an HOV bypass lane or a two-lane merge beyond the ramp meter, then provide illumination for the entire ramp from the beginning of the on-ramp to the ramp merge point with the main line (see Exhibit 1040-3).

(18) Safety Rest Areas

Provide illumination within rest areas at the roadway diverge and merge sections, the walkways between parking areas and rest room buildings, and the parking areas the same as for a major parking lot (see Exhibit 1040-19).

(19) Chain-Up/Chain-Off Parking Areas

Provide the necessary number of luminaires to illuminate the design area of the chain-up/chain-off parking area (see Exhibit 1040-20).

(20) Tunnels

Long tunnels have a portal-to-portal length greater than the stopping sight distance. Provide both nighttime and daytime illumination for long tunnels. Consider illumination for short tunnels if the horizontal-to-vertical ratio is $\geq 10:1$ (see Chapter 1260 and Exhibit 1040-21). Provide daytime security lighting in pedestrian tunnels.

(21) Bridge Inspection Lighting

Provide the necessary number of light fixtures to illuminate the interior inspection areas of floating bridges and steel box girder bridges (see Exhibit 1040-22). Coordinate bridge illumination requirements with the HQ Bridge and Structures Office.

(22) Same Direction Traffic Split Around an Obstruction

Provide the necessary number of light standards to illuminate the design area where traffic is split around an obstruction. This requirement applies to permanent and temporary same-direction split channelization. For temporary work zones, illuminate the obstruction for the duration of the traffic split (see Exhibit 1040-23).

(23) Overhead Sign Illumination

Provide sign lighting on overhead signs as discussed in Chapter 1020. Sign illumination is provided with sign lighting fixtures mounted directly below the sign. The light source of the fixture is an 85 watt induction lamp. Provide one sign with a width of 16 feet or less. For wider signs, provide two or more sign lights with a spacing not exceeding 16 feet. If two or more closely spaced signs are in the same vertical plane on the structure, consider the signs as one unit and use a uniform light fixture spacing for the entire width. Voltage drops can be significant when the electrical service is not nearby. In areas where an electrical power source is more than $\frac{1}{2}$ mile away, utility company installation costs can be prohibitive. With justification, overhead sign illumination is not required where the power source is more than $\frac{1}{2}$ mile away.

1040.06 Additional Illumination

At certain locations, additional illumination is desirable to provide better definition of nighttime driving conditions or to provide consistency with local agency goals and enhancement projects. For Improvement projects on state highways, additional illumination is considered under certain circumstances, which are listed in this section. Justify the additional illumination in the Design Documentation Package (DDP).

(1) **Conditions for Additional Illumination**

Following are some conditions used in making the decision to provide additional illumination:

(a) **Diminished Level of Service**

Diminished level of service is a mobility condition where the nighttime peak hour level of service is D or lower. To determine the level of service, use traffic volume counts taken during the evening peak hour. Peaking characteristics in urban areas are related to the time of day. Traffic counts taken in the summer between 4:30 p.m. and 7:30 a.m. may be used as nighttime volumes if adjustment factors for differences in seasonal traffic volumes are applied for November, December, and January.

(b) **Nighttime Collision Frequency**

This is when the number of nighttime collisions equals or exceeds the number of daytime collisions. An engineering study indicating that illumination will result in a reduction in nighttime collisions is required as justification. Consider the seasonal variations in lighting conditions when reviewing reported collisions. Collision reporting forms, using a specific time period to distinguish between “day” and “night,” might not indicate the actual lighting conditions at the time of a collision. Consider the time of year when determining whether a collision occurred at nighttime. A collision occurring at 5:00 p.m. in July would be a daytime collision, but a collision occurring at the same time in December would be during the hours of darkness.

(c) **Nighttime Pedestrian Accident Locations (PALs)**

The mitigation of nighttime PALs requires different lighting strategies than vehicular collision locations. Provide light levels to emphasize crosswalks and adjacent sidewalks. Multilane highways with two-way left-turn lanes, in areas transitioning from rural land use to urban land use, or areas experiencing commercial growth or commercial redevelopment, are typically high-speed facilities with numerous road approaches and driveways. These approaches allow numerous vehicle entry and exit points and provide few crossing opportunities for pedestrians; consider additional illumination.

(2) **Highways**

Proposals to provide full (continuous) illumination require the approval of the State Traffic Engineer. Regions may choose to develop (regional or corridor-specific) system plans for providing full (continuous) illumination. The State Traffic Engineer’s approval of a system plan will eliminate the need for a project-specific approval from the State Traffic Engineer.

The decision whether to provide full (continuous) illumination is to be made during the scoping stage and communicated to the designers as soon as possible.

- (a) On the main line of full limited access highways, consider full (continuous) illumination if a diminished level of service exists and any two of the following conditions are satisfied:

This form (or a reasonable facsimile) must be completed for all Intelligent Transportation Systems (ITS) projects and included in the DDP. Submit the form to FHWA with the construction authorization request for all federal-aid projects that include ITS.

Name of Project:

Regional ITS Architecture:

- 1. Identify the portions of the Regional ITS Architecture being implemented. Is the project consistent with the architecture? Are revisions to the architecture required?**

Identify which user services, physical subsystems, information flows, and market packages are being completed as part of the project and explain how these pieces are part of the regional architecture.

- 2. Identify the participating agencies, their roles and responsibilities, and concept of operations:**

For the user services to be implemented, define the high-level operations of the system, including where the system will be used; functions of the system; performance parameters; the life cycle of the system; and who will operate and maintain the system. Establish requirements or agreements on information sharing and traffic device control responsibilities. The regional architecture operational concept is a good starting point for discussion.

- 3. Define the system requirements:**

Based on the above concept of operations, define the “what” and not the “how” of the system. During the early stages of the systems engineering process, break down the process into detailed requirements for eventual detailed design. The applicable high-level functional requirements from the regional architecture are a good starting point for discussion. A review of the requirements by the project stakeholders is recommended.

- 4. Provide an analysis of alternative system configurations and technology options to meet requirements:**

The analysis of system alternatives should outline the strengths and weaknesses, technical feasibility, institutional compatibility, and life cycle costs of each alternative. The project stakeholders should have input in choosing the preferred solution.

ITS Project Systems Engineering Review Form (With Instructions)

Exhibit 1050-2

5. Identify procurement options:

Some procurement (contracting) options to consider include: consultant design/low-bid contractor, systems manager, systems integrator, task order, and design/build. The decision regarding the best procurement option should consider the level of agency participation, compatibility with existing procurement methods, role of system integrator, and life cycle costs.

There are different procurement methods for different types of projects. If the project significantly meets the definition of construction, then construction by low-bid contract would be used. If the project significantly meets the definition of software development/ hardware acquisition (in other words, an information technology project), then follow the acquisition processes outlined in the WSDOT Purchasing Manual. This option includes services for systems integration, systems management, and design.

Contact the WSDOT HQ Traffic Office for additional guidance and procurement options.

6. Identify the applicable ITS standards and testing procedures:

Include documentation on which standards will be incorporated into the system design and justification for any applicable standards not incorporated. The standards report from the regional architecture is a good starting point for discussion.

7. Delineate the procedures and resources necessary for operations and management of the system:

In addition to the above concept of operations, document any internal policies or procedures necessary to recognize and incorporate the new system into the current operations and decision-making processes. Resources necessary to support continued operations, including staffing and training must also be recognized early and be provided for. Such resources must also be provided to support necessary maintenance and upkeep to ensure continued system viability.



Design Manual

Volume 2 – Design Criteria

M 22-01.08

July 2011

Division 11 – Project Design Criteria
Division 12 – Geometrics
Division 13 – Intersections and Interchanges
Division 14 – HOV and Transit
Division 15 – Pedestrian and Bicycle Facilities
Division 16 – Roadside Safety Elements
Division 17 – Roadside Facilities

Environmental and Engineering Programs

Design Office

Americans with Disabilities Act (ADA) Information

Materials can be provided in alternative formats for persons with disabilities by contacting the ADA Compliance Officer via telephone at 360-705-7097 or by e-mail to Shawn Murinko at murinks@wsdot.wa.gov.

Title VI Notice to Public

It is Washington State Department of Transportation (WSDOT) policy to ensure no person shall, on the grounds of race, color, national origin, or sex, as provided by Title VI of the Civil Rights Act of 1964, be excluded from participation in, be denied the benefits of, or be otherwise discriminated against under any of its federally funded programs and activities. Any person who believes his/her Title VI protection has been violated may file a complaint with WSDOT's Office of Equal Opportunity (OEO). For Title VI complaint forms and advice, please contact OEO's Title VI Coordinator at 360-705-7098.

To get the latest information on WSDOT administrative and engineering manuals, sign up for e-mail updates for individual manuals at:
www.wsdot.wa.gov/publications/manuals/

Washington State Department of Transportation
Administrative and Engineering Publications
PO Box 47304
Olympia, WA 98504-7304

Phone: 360-705-7430

Fax: 360-705-6861

E-mail: enrpubs@wsdot.wa.gov

Internet: www.wsdot.wa.gov/publications/manuals/

Division 1 – General Information

- Chapter 100 Manual Description**
 - 100.01 Purpose
 - 100.02 Presentation and Revisions
 - 100.03 Manual Applications
 - 100.04 Manual Use
 - 100.05 Manual Organization

- Chapter 110 Design-Build Projects**
 - 110.01 General
 - 110.02 References
 - 110.03 Terminology and Language Used
 - 110.04 Design and Documentation Responsibility

- Chapter 120 Planning**
 - 120.01 General
 - 120.02 References
 - 120.03 Acronyms and Definitions
 - 120.04 Legislation and Policy Development
 - 120.05 Planning at WSDOT
 - 120.06 Linking Transportation Plans
 - 120.07 Linking WSDOT Planning to Programming

- Chapter 130 Project Development Sequence**
 - 130.01 General
 - 130.02 References
 - 130.03 Definitions
 - 130.04 Project Development Sequence

Division 2 – Hearings, Environmental, and Permits

- Chapter 210 Public Involvement and Hearings**
 - 210.01 General
 - 210.02 References
 - 210.03 Definitions
 - 210.04 Public Involvement
 - 210.05 Public Hearings
 - 210.06 Environmental Hearing
 - 210.07 Corridor Hearing
 - 210.08 Design Hearing
 - 210.09 Limited Access Hearing
 - 210.10 Combined Hearings
 - 210.11 Administrative Appeal Hearing
 - 210.12 Follow-Up Hearing
 - 210.13 Documentation

Chapter 220	Project Environmental Documentation
220.01	General
220.02	References
220.03	Definitions/Acronyms
220.04	Determining the Environmental Documentation
220.05	Identifying the Project Classification
220.06	Environmental Impact Statements: Class I Projects
220.07	Categorical Exclusions: Class II Projects
220.08	Environmental Assessments: Class III Projects
220.09	Reevaluations
220.10	Commitment File
220.11	Documentation

Chapter 230	Environmental Permits and Approvals
230.01	General
230.02	Permits and Approvals
230.03	Project Types and Permits
230.04	Design Process and Permit Interaction

Division 3 – Project Documentation

Chapter 300	Design Documentation, Approval, and Process Review
300.01	General
300.02	References
300.03	Definitions
300.04	Design Documentation
300.05	Project Development
300.06	FHWA Approval
300.07	Design Approval
300.08	Project Development Approval
300.09	Process Review

Chapter 305	Managing Projects
305.01	Introduction
305.02	References
305.03	Definitions
305.04	Design Project Management Overview
305.05	Cost Estimating for Design Project Development
305.06	Value Engineering
305.07	Context Sensitive Design (CSS)
305.08	Additional Design Resources

Chapter 310	Value Engineering
310.01	General
310.02	References
310.03	Definitions
310.04	Procedure
310.05	Documentation

Chapter 320	Traffic Analysis
320.01	General
320.02	References
320.03	Design Year
320.04	Definitions
320.05	Travel Forecasting (Transportation Modeling)
320.06	Traffic Analysis

- 320.07 Scope of Traffic Impact Analysis
- 320.08 Traffic Data
- 320.09 Traffic Impact Analysis Methodologies
- 320.10 Traffic Analysis Software
- 320.11 Mitigation Measures
- 320.12 Traffic Impact Analysis Report

Division 4 – Surveying

Chapter 400 Surveying and Mapping

- 400.01 General
- 400.02 References
- 400.03 Procedures
- 400.04 Datums
- 400.05 Global Positioning System
- 400.06 WSDOT Survey Monument Database
- 400.07 Geographic Information System
- 400.08 Photogrammetric Surveys
- 400.09 Documentation

Chapter 410 Monumentation

- 410.01 General
- 410.02 References
- 410.03 Definitions
- 410.04 Control Monuments
- 410.05 Alignment Monuments
- 410.06 Property Corners
- 410.07 Other Monuments
- 410.08 Filing Requirements
- 410.09 Documentation

Division 5 – Right of Way and Access Control

Chapter 510 Right of Way Considerations

- 510.01 General
- 510.02 References
- 510.03 Special Features
- 510.04 Easements and Permits
- 510.05 Programming for Funds
- 510.06 Appraisal and Acquisition
- 510.07 Transactions
- 510.08 Documentation

Chapter 520 Access Control

- 520.01 General
- 520.02 References
- 520.03 Definitions
- 520.04 Vocabulary

Chapter 530 Limited Access Control

- 530.01 General
- 530.02 Achieving Limited Access
- 530.03 Full Control (Most Restrictive)
- 530.04 Partial Control
- 530.05 Modified Control (Least Restrictive)
- 530.06 Access Approaches

- 530.07 Frontage Roads
- 530.08 Turnbacks
- 530.09 Adjacent Railroads
- 530.10 Modifications to Limited Access Highways
- 530.11 Documentation

Chapter 540 Managed Access Control

- 540.01 General
- 540.02 References
- 540.03 Definitions
- 540.04 Design Considerations
- 540.05 Managed Access Highway Classes
- 540.06 Corner Clearance Criteria
- 540.07 Access Connection Categories
- 540.08 Access Connection Permit
- 540.09 Permitting and Design Documentation
- 540.10 Other Considerations
- 540.11 Preconstruction Conference
- 540.12 Adjudicative Proceedings
- 540.13 Documentation

Chapter 550 Interchange Justification Report

- 550.01 General
- 550.02 References
- 550.03 Definitions
- 550.04 Procedures
- 550.05 Interchange Justification Report and Supporting Analyses
- 550.06 Report Organization and Appendices
- 550.07 Updating an IJR
- 550.08 Documentation

Chapter 560 Fencing

- 560.01 General
- 560.02 References
- 560.03 Design Criteria
- 560.04 Fencing Types
- 560.05 Gates
- 560.06 Procedure
- 560.07 Documentation

Division 6 – Soils and Paving

Chapter 610 Investigation of Soils, Rock, and Surfacing Materials

- 610.01 General
- 610.02 References
- 610.03 Materials Sources
- 610.04 Geotechnical Investigation, Design, and Reporting
- 610.05 Use of Geotechnical Consultants
- 610.06 Geotechnical Work by Others
- 610.07 Surfacing Report
- 610.08 Documentation

Chapter 620 Design of Pavement Structure

- 620.01 General
- 620.02 Estimating Tables

- Chapter 630 Geosynthetics**
630.01 General
630.02 References
630.03 Geosynthetic Types and Characteristics
630.04 Geosynthetic Function Definitions and Applications
630.05 Design Approach for Geosynthetics
630.06 Design Responsibility
630.07 Documentation

Division 7 – Structures

- Chapter 700 Project Development Roles and Responsibilities for Projects With Structures**
700.01 General
700.02 Procedures
- Chapter 710 Site Data for Structures**
710.01 General
710.02 References
710.03 Required Data for All Structures
710.04 Additional Data for Waterway Crossings
710.05 Additional Data for Grade Separations
710.06 Additional Data for Widening
710.07 Documentation
- Chapter 720 Bridges**
720.01 General
720.02 References
720.03 Bridge Locations
720.04 Bridge Site Design Elements
720.05 Documentation
- Chapter 730 Retaining Walls and Steep Reinforced Slopes**
730.01 General
730.02 References
730.03 Design Principles
730.04 Design Requirements
730.05 Guidelines for Wall/Slope Selection
730.06 Design Responsibility and Process
730.07 Documentation
- Chapter 740 Noise Barriers**
740.01 General
740.02 References
740.03 Design
740.04 Procedures
740.05 Documentation

Division 8 – Hydraulics

- Chapter 800 Hydraulic Design**
800.01 General
800.02 References
800.03 Hydraulic Considerations
800.04 Safety Considerations
800.05 Design Responsibility
800.06 Documentation

Division 9 – Roadside Development

- Chapter 900 Roadside Development**
 - 900.01 General
 - 900.02 References
 - 900.03 Legal Requirements
 - 900.04 Roadside Classification Plan
 - 900.05 Roadside Manual
 - 900.06 Project Development
 - 900.07 Documentation

- Chapter 910 Contour Grading**
 - 910.01 General
 - 910.02 References
 - 910.03 Procedures
 - 910.04 Recommendations
 - 910.05 Documentation

- Chapter 920 Vegetation**
 - 920.01 General
 - 920.02 References
 - 920.03 Discussion
 - 920.04 Design Guidelines
 - 920.05 Documentation

- Chapter 930 Irrigation**
 - 930.01 General
 - 930.02 References
 - 930.03 Design Considerations
 - 930.04 Documentation

- Chapter 940 Soil Bioengineering**
 - 940.01 General
 - 940.02 References
 - 940.03 Uses for Soil Bioengineering
 - 940.04 Design Responsibilities and Considerations
 - 940.05 Documentation

- Chapter 950 Public Art**
 - 950.01 General
 - 950.02 References
 - 950.03 Definitions
 - 950.04 Standard Architectural Design
 - 950.05 Criteria for Public Art
 - 950.06 Process and Project Delivery Timing
 - 950.07 Approvals
 - 950.08 Documentation

Division 10 – Traffic Safety Elements

Chapter 1010 Work Zone Safety and Mobility

- 1010.01 General
- 1010.02 References
- 1010.03 Definitions
- 1010.04 Work Zone Safety and Mobility
- 1010.05 Transportation Management Plans and Significant Projects
- 1010.06 Work Zone TMP Strategy Development
- 1010.07 Capacity Analysis
- 1010.08 Work Zone Design Standards
- 1010.09 Temporary Traffic Control Devices
- 1010.10 Other Traffic Control Devices or Features
- 1010.11 Traffic Control Plan Development and PS&E
- 1010.12 Training and Resources
- 1010.13 Documentation

Chapter 1020 Signing

- 1020.01 General
- 1020.02 References
- 1020.03 Design Components
- 1020.04 Overhead Installation
- 1020.05 State Highway Route Numbers
- 1020.06 Mileposts
- 1020.07 Guide Sign Plan
- 1020.08 Documentation

Chapter 1030 Delineation

- 1030.01 General
- 1030.02 References
- 1030.03 Definitions
- 1030.04 Pavement Markings
- 1030.05 Guideposts
- 1030.06 Barrier Delineation
- 1030.07 Object Markers
- 1030.08 Wildlife Warning Reflectors
- 1030.09 Documentation

Chapter 1040 Illumination

- 1040.01 General
- 1040.02 References
- 1040.03 Definitions
- 1040.04 Design Considerations
- 1040.05 Required Illumination
- 1040.06 Additional Illumination
- 1040.07 Design Criteria
- 1040.08 Documentation

Chapter 1050 Intelligent Transportation Systems

- 1050.01 General
- 1050.02 References
- 1050.03 Systems Engineering
- 1050.04 Documentation

Division 11 – Project Design Criteria**Chapter 1100 Design Matrix Procedures**

- 1100.01 General
- 1100.02 Selecting a Design Matrix
- 1100.03 Using a Design Matrix

Chapter 1110 Minor Operational Enhancement Projects

- 1110.01 General
- 1110.02 References
- 1110.03 Definitions
- 1110.04 Minor Operational Enhancement Matrix Procedures
- 1110.05 Selecting a Minor Operational Enhancement Matrix
- 1110.06 Project Type
- 1110.07 Using a Minor Operational Enhancement Matrix
- 1110.08 Project Approval
- 1110.09 Documentation

Chapter 1120 Basic Design Level

- 1120.01 General
- 1120.02 Basic Safety
- 1120.03 Minor Safety and Minor Preservation Work
- 1120.04 Documentation

Chapter 1130 Modified Design Level

- 1130.01 General
- 1130.02 Design Speed
- 1130.03 Alignment
- 1130.04 Roadway Widths
- 1130.05 Cross Slopes
- 1130.06 Sideslopes
- 1130.07 Bike and Pedestrian
- 1130.08 Bridges
- 1130.09 Intersections
- 1130.10 Documentation

Chapter 1140 Full Design Level

- 1140.01 General
- 1140.02 References
- 1140.03 Definitions
- 1140.04 Functional Classification
- 1140.05 Terrain Classification
- 1140.06 Geometric Design Data
- 1140.07 Design Speed
- 1140.08 Traffic Lanes
- 1140.09 Shoulders
- 1140.10 Medians
- 1140.11 Curbs
- 1140.12 Parking
- 1140.13 Pavement Type
- 1140.14 Structure Width

- 1140.15 Right of Way Width
- 1140.16 Grades
- 1140.17 Fencing
- 1140.18 Traffic Signal Control, Illumination, and Intelligent Transportation Systems (ITS)
- 1140.19 Documentation

Division 12 – Geometrics

Chapter 1210 Geometric Plan Elements

- 1210.01 General
- 1210.02 References
- 1210.03 Definitions
- 1210.04 Horizontal Alignment
- 1210.05 Distribution Facilities
- 1210.06 Number of Lanes and Arrangement
- 1210.07 Pavement Transitions
- 1210.08 Procedures
- 1210.09 Documentation

Chapter 1220 Geometric Profile Elements

- 1220.01 General
- 1220.02 References
- 1220.03 Vertical Alignment
- 1220.04 Coordination of Vertical and Horizontal Alignments
- 1220.05 Airport Clearance
- 1220.06 Railroad Crossings
- 1220.07 Procedures
- 1220.08 Documentation

Chapter 1230 Geometric Cross Section

- 1230.01 General
- 1230.02 References
- 1230.03 Definitions
- 1230.04 Roadways
- 1230.05 Medians and Outer Separations
- 1230.06 Roadsides
- 1230.07 Roadway Sections
- 1230.08 Documentation

Chapter 1240 Turning Roadways

- 1240.01 General
- 1240.02 References
- 1240.03 Definitions
- 1240.04 Turning Roadway Widths
- 1240.05 Documentation

Chapter 1250 Superelevation

- 1250.01 General
- 1250.02 References
- 1250.03 Definitions
- 1250.04 Superelevation Rate Selection
- 1250.05 Existing Curves
- 1250.06 Turning Movements at Intersections
- 1250.07 Runoff for Highway Curves
- 1250.08 Runoff for Ramp Curves
- 1250.09 Documentation

Chapter 1260 Sight Distance

- 1260.01 General
- 1260.02 References
- 1260.03 Definitions
- 1260.04 Stopping Sight Distance
- 1260.05 Passing Sight Distance
- 1260.06 Decision Sight Distance
- 1260.07 Documentation

Chapter 1270 Auxiliary Lanes

- 1270.01 General
- 1270.02 References
- 1270.03 Definitions
- 1270.04 Climbing Lanes
- 1270.05 Passing Lanes
- 1270.06 Slow-Moving Vehicle Turnouts
- 1270.07 Shoulder Driving for Slow Vehicles
- 1270.08 Emergency Escape Ramps
- 1270.09 Chain-Up and Chain-Off Areas
- 1270.10 Documentation

Division 13 – Intersections and Interchanges**Chapter 1310 Intersections at Grade**

- 1310.01 General
- 1310.02 References
- 1310.03 Definitions
- 1310.04 Intersection Configurations
- 1310.05 Design Considerations
- 1310.06 Design Vehicle Selection
- 1310.07 Design Elements
- 1310.08 U-Turns
- 1310.09 Intersection Sight Distance
- 1310.10 Traffic Control at Intersections
- 1310.11 Signing and Delineation
- 1310.12 Procedures
- 1310.13 Documentation

Chapter 1320 Roundabouts

- 1320.01 General
- 1320.02 References
- 1320.03 Definitions
- 1320.04 Roundabout Types
- 1320.05 Capacity Analysis
- 1320.06 Geometric Design
- 1320.07 Pedestrians
- 1320.08 Bicycles
- 1320.09 Signing and Pavement Marking
- 1320.10 Illumination
- 1320.11 Access, Parking, and Transit Facilities
- 1320.12 Design Procedures
- 1320.13 Documentation

Chapter 1330	Traffic Control Signals
1330.01	General
1330.02	References
1330.03	Definitions
1330.04	Procedures
1330.05	Signal Warrants
1330.06	Conventional Traffic Signal Design
1330.07	Documentation
Chapter 1340	Road Approaches
1340.01	General
1340.02	References
1340.03	Definitions
1340.04	Design Considerations
1340.05	Road Approach Design Template
1340.06	Sight Distance
1340.07	Road Approach Location
1340.08	Drainage
1340.09	Procedures
1340.10	Documentation
Chapter 1350	Railroad Grade Crossings
1350.01	General
1350.02	References
1350.03	Plans
1350.04	Traffic Control Systems
1350.05	Nearby Roadway Intersections
1350.06	Pullout Lanes
1350.07	Crossing Surfaces
1350.08	Crossing Closure
1350.09	Traffic Control During Construction and Maintenance
1350.10	Railroad Grade Crossing Petitions and WUTC Orders
1350.11	Grade Crossing Improvement Projects
1350.12	Light Rail
1350.13	Documentation
Chapter 1360	Interchanges
1360.01	General
1360.02	References
1360.03	Definitions
1360.04	Interchange Design
1360.05	Ramps
1360.06	Interchange Connections
1360.07	Ramp Terminal Intersections at Crossroads
1360.08	Interchanges on Two-Lane Highways
1360.09	Interchange Plans for Approval
1360.10	Documentation
Chapter 1370	Median Crossovers
1370.01	General
1370.02	Analysis
1370.03	Design
1370.04	Plan Updates and Approvals
1370.05	Documentation

Division 14 – HOV and Transit

Chapter 1410 High-Occupancy Vehicle Facilities

- 1410.01 General
- 1410.02 References
- 1410.03 Definitions
- 1410.04 Preliminary Design and Planning
- 1410.05 Operations
- 1410.06 Design Criteria
- 1410.07 Documentation

Chapter 1420 HOV Direct Access

- 1420.01 General
- 1420.02 References
- 1420.03 Definitions
- 1420.04 HOV Access Types and Locations
- 1420.05 Direct Access Geometrics
- 1420.06 Passenger Access
- 1420.07 Traffic Design Elements
- 1420.08 Documentation

Chapter 1430 Transit Facilities

- 1430.01 General
- 1430.02 References
- 1430.03 Definitions
- 1430.04 Park & Ride Lots
- 1430.05 Transfer/Transit Centers
- 1430.06 Bus Stops and Pullouts
- 1430.07 Passenger Amenities
- 1430.08 Roadway Design and Design Vehicle Characteristics
- 1430.09 Intersection Radii
- 1430.10 Universal Access
- 1430.11 Documentation

Division 15 – Pedestrian and Bicycle Facilities

Chapter 1510 Pedestrian Facilities

- 1510.01 General
- 1510.02 References
- 1510.03 Definitions
- 1510.04 Policy
- 1510.05 ADA Requirements by Project Type
- 1510.06 Pedestrian Circulation Paths
- 1510.07 Pedestrian Access Routes
- 1510.08 Sidewalks
- 1510.09 Curb Ramps
- 1510.10 Crosswalks
- 1510.11 Raised Medians/Traffic Islands
- 1510.12 Pedestrian Push Buttons at Signals
- 1510.13 At-Grade Railroad Crossings
- 1510.14 Pedestrian Grade Separations (Structures)
- 1510.15 Other Pedestrian Facilities
- 1510.16 Illumination and Signing
- 1510.17 Work Zone Pedestrian Accommodation
- 1510.18 Documentation

- Chapter 1515 Shared-Use Paths**
 - 1515.01 General
 - 1515.02 Definitions
 - 1515.03 Shared-Use Path Design
 - 1515.04 Documentation

- Chapter 1520 Roadway Bicycle Facilities**
 - 1520.01 General
 - 1520.02 References
 - 1520.03 Definitions
 - 1520.04 Facility Selection
 - 1520.05 Project Requirements
 - 1520.06 Shared-Use Path Design
 - 1520.07 Shared Roadway Bicycle Facility Design
 - 1520.08 Signed Shared Bicycle Roadway Design
 - 1520.09 Bicycle Lane Design
 - 1520.10 Documentation

Division 16 – Roadside Safety Elements

- Chapter 1600 Roadside Safety**
 - 1600.01 General
 - 1600.02 References
 - 1600.03 Definitions
 - 1600.04 Clear Zone
 - 1600.05 Features to Be Considered for Mitigation
 - 1600.06 Median Considerations
 - 1600.07 Other Roadside Safety Features
 - 1600.08 Documentation

- Chapter 1610 Traffic Barriers**
 - 1610.01 General
 - 1610.02 References
 - 1610.03 Definitions
 - 1610.04 Project Criteria
 - 1610.05 Barrier Design
 - 1610.06 Beam Guardrail
 - 1610.07 Cable Barrier
 - 1610.08 Concrete Barrier
 - 1610.09 Special-Use Barriers
 - 1610.10 Bridge Traffic Barriers
 - 1610.11 Other Barriers
 - 1610.12 Documentation

- Chapter 1620 Impact Attenuator Systems**
 - 1620.01 General
 - 1620.02 Design Criteria
 - 1620.03 Selection
 - 1620.04 Documentation

Division 17 – Roadside Facilities

Chapter 1710 Safety Rest Areas and Traveler Services

- 1710.01 General
- 1710.02 References
- 1710.03 Documentation

Chapter 1720 Weigh Sites

- 1720.01 General
- 1720.02 Definitions
- 1720.03 Planning, Development, and Responsibilities
- 1720.04 Permanent Facilities
- 1720.05 Portable Facilities
- 1720.06 Shoulder Sites
- 1720.07 Federal Participation
- 1720.08 Procedures
- 1720.09 Documentation

Exhibit 110-1	Design Documentation Sequence for a Typical Design-Build Project
Exhibit 120-1	Relationship Between Transportation Plans and Planning Organizations
Exhibit 120-2	Transportation Improvement Programs
Exhibit 120-3	Linking Planning and Programming
Exhibit 130-1	Program Elements: Highway Preservation
Exhibit 130-2	Program Elements: Highway Improvement
Exhibit 130-3	Highway System Plan Implementation
Exhibit 210-1	Types of Public Hearings
Exhibit 210-2	Public Hearing Formats
Exhibit 210-3	Prehearing Packet Checklist
Exhibit 210-4	Sequence for Corridor, Design, and Environmental Hearings
Exhibit 210-5	Sequence for Limited Access Hearing
Exhibit 210-6	Hearing Summary Approvals
Exhibit 230-1	Project Environmental Matrix 1: Permit Probabilities for Interstate Routes (Main Line)
Exhibit 230-2	Project Environmental Matrix 2: Permit Probabilities for Interstate Interchange Areas
Exhibit 230-3	Project Environmental Matrix 3: Permit Probabilities for NHS Routes, Non-Interstate (Main Line)
Exhibit 230-4	Project Environmental Matrix 4: Permit Probabilities for Interchange Areas, NHS (Except Interstate), and Non-NHS
Exhibit 230-5	Project Environmental Matrix 5: Non-NHS Routes (Main Line)
Exhibit 230-6	Endnotes for Project Environmental Matrices
Exhibit 230-7	Environmental Interrelationship: HMA/PCCP/BST Main Line Overlay
Exhibit 230-8	Environmental Interrelationship: Safety Corridor Channelization Main Line
Exhibit 300-1	Design Matrix Documentation Requirements
Exhibit 300-2	Design Approval Level
Exhibit 300-3	Approvals
Exhibit 300-4	PS&E Process Approvals
Exhibit 300-5	Common Components of Design Documentation Package
Exhibit 300-6	Evaluate Upgrade (EU) Documentation Contents List
Exhibit 300-7	Deviation Request and Project Analysis Contents List
Exhibit 300-8	Design to Construction Transition Project Turnover Checklist Example
Exhibit 305-1	WSDOT Project Management Process
Exhibit 310-1	Seven-Phase Job Plan for VE Studies
Exhibit 310-2	VE Study Team Tools
Exhibit 320-1	Measures of Effectiveness by Facility Type
Exhibit 400-1	Interagency Agreement

Exhibit 400-2	Report of Survey Mark Example
Exhibit 410-1	Monument Documentation Summary
Exhibit 410-2	DNR Permit Application
Exhibit 410-3	DNR Completion Report Form
Exhibit 410-4	Land Corner Record
Exhibit 510-1	Appraisal and Acquisition
Exhibit 520-1	Access Control Vocabulary
Exhibit 530-1a	Full Access Control Limits: Interchange
Exhibit 530-1b	Full Access Control Limits: Interchange
Exhibit 530-1c	Full Access Control Limits: Interchange With Roundabouts
Exhibit 530-1d	Full Access Control Limits: Ramp Terminal With Transition Taper
Exhibit 530-1e	Full Access Control Limits: Single Point Urban Interchange
Exhibit 530-2a	Partial Access Control Limits: At-Grade Intersections
Exhibit 530-2b	Partial Access Control Limits: Roundabout Intersections
Exhibit 530-3a	Modified Access Control Limits: Roundabout Intersections
Exhibit 530-3b	Modified Access Control Limits: Intersections
Exhibit 540-1	Minimum Corner Clearance: Distance From Access Connection to Public Road or Street
Exhibit 540-2	Managed Access Highway Class Description
Exhibit 550-1	Interstate Routes: Interchange Justification Report Content and Review Levels
Exhibit 550-2	Non-Interstate Routes: IJR Content and Review Levels
Exhibit 550-3	Interstate IJR: Process Flow Chart
Exhibit 550-4	Non-Interstate IJR: Process Flow Chart
Exhibit 550-5	IJR: Stamped Cover Sheet Example
Exhibit 610-1	Materials Source Development
Exhibit 620-1	Estimating: Miscellaneous Tables
Exhibit 620-2a	Estimating: Hot Mix Asphalt Pavement and Asphalt Distribution Tables
Exhibit 620-2b	Estimating: Asphalt Distribution Tables
Exhibit 620-3	Estimating: Bituminous Surface Treatment
Exhibit 620-4	Estimating: Base and Surfacing Typical Section Formulae and Example
Exhibit 620-5a	Estimating: Base and Surfacing Quantities
Exhibit 620-5b	Estimating: Base and Surfacing Quantities
Exhibit 620-5c	Estimating: Base and Surfacing Quantities
Exhibit 620-5d	Estimating: Base and Surfacing Quantities
Exhibit 620-5e	Estimating: Base and Surfacing Quantities
Exhibit 620-5f	Estimating: Base and Surfacing Quantities
Exhibit 620-5g	Estimating: Base and Surfacing Quantities
Exhibit 620-5h	Estimating: Base and Surfacing Quantities
Exhibit 630-1	Selection Criteria for Geotextile Class

Exhibit 630-2	Maximum Sheet Flow Lengths for Silt Fences
Exhibit 630-3	Maximum Contributing Area for Ditch and Swale Applications
Exhibit 630-4	Design Process for Drainage and Erosion Control: Geotextiles and Nonstandard Applications
Exhibit 630-5	Design Process for Separation, Soil Stabilization, and Silt Fence
Exhibit 630-6	Examples of Various Geosynthetics
Exhibit 630-7	Geotextile Application Examples
Exhibit 630-8	Definition of Slope Length
Exhibit 630-9	Definition of Ditch or Swale Storage Length and Width
Exhibit 630-10	Silt Fences for Large Contributing Area
Exhibit 630-11	Silt Fence End Treatment
Exhibit 630-12	Gravel Check Dams for Silt Fences
Exhibit 700-1	Determination of the Roles and Responsibilities for Projects With Structures: Project Development Phase
Exhibit 710-1	Bridge Site Plan Scales
Exhibit 710-2	Bridge Site Data Checklist
Exhibit 720-1	Bridge Vertical Clearances
Exhibit 720-2	Highway Structure Over Railroad
Exhibit 720-3	Embankment Slope at Bridge Ends
Exhibit 730-1	Summary of Mechanically Stabilized Earth (MSE) Gravity Wall/Slope Options Available
Exhibit 730-2	Summary of Prefabricated Modular Gravity Wall Options Available
Exhibit 730-3	Summary of Rigid Gravity and Semigravity Wall Options Available
Exhibit 730-4	Summary of Nongravity Wall Options Available
Exhibit 730-5	Summary of Anchored Wall Options Available
Exhibit 730-6	Other Wall/Slope Options Available
Exhibit 730-7	Typical Mechanically Stabilized Earth Gravity Walls
Exhibit 730-8	Typical Prefabricated Modular Gravity Walls
Exhibit 730-9	Typical Rigid Gravity, Semigravity Cantilever, Nongravity Cantilever, and Anchored Walls
Exhibit 730-10	Typical Rockery and Reinforced Slopes
Exhibit 730-11	MSE Wall Drainage Detail
Exhibit 730-12	Retaining Walls With Traffic Barriers
Exhibit 730-13a	Retaining Wall Design Process
Exhibit 730-13b	Retaining Wall Design Process: Proprietary
Exhibit 740-1	Standard Noise Wall Types
Exhibit 900-1	Funding Source Determines Extent of Restoration
Exhibit 940-1	Soil Bioengineering Design
Exhibit 1010-1	General Lane Closure Work Zone Capacity
Exhibit 1010-2	Minimum Work Zone Clear Zone Distance

Exhibit 1010-3	Transportation Management Plan Components Checklist
Exhibit 1010-4	Abrupt Edge Pavement Drop-Off Protection
Exhibit 1020-1	Reflective Sheeting Requirements for Overhead Signs
Exhibit 1020-2	Timber Posts
Exhibit 1020-3	Wide Flange Steel Posts
Exhibit 1020-4	Laminated Wood Box Posts
Exhibit 1030-1	Pavement Marking Material Guide
Exhibit 1030-2	Guidepost Placement
Exhibit 1040-1a	Freeway Lighting Applications
Exhibit 1040-1b	Freeway Lighting Applications
Exhibit 1040-1c	Freeway Lighting Applications
Exhibit 1040-2	Freeway Ramp Terminals
Exhibit 1040-3	Ramp With Meter
Exhibit 1040-4	Freeway-to-Freeway Connection
Exhibit 1040-5	HOT (High-Occupancy Toll) Lane Enter/Exit Zone
Exhibit 1040-6	Lane Reduction
Exhibit 1040-7	Add Lane
Exhibit 1040-8a	Intersection With Left-Turn Channelization: Divided Highway
Exhibit 1040-8b	Intersections With Left-Turn Channelization
Exhibit 1040-9	Intersections With Drop Lane/Right-Turn Lane Channelization
Exhibit 1040-10	Intersections With Traffic Signals
Exhibit 1040-11	Intersection Without Channelization
Exhibit 1040-12	Roundabout
Exhibit 1040-13	Railroad Crossing With Gates or Signals
Exhibit 1040-14	Midblock Pedestrian Crossing
Exhibit 1040-15	Transit Flyer Stop
Exhibit 1040-16	Major Parking Lot
Exhibit 1040-17	Minor Parking Lot
Exhibit 1040-18	Truck Weigh Site
Exhibit 1040-19	Safety Rest Area
Exhibit 1040-20	Chain-Up/Chain-Off Parking Area
Exhibit 1040-21	Tunnel
Exhibit 1040-22	Bridge Inspection Lighting System
Exhibit 1040-23	Traffic Split Around an Obstruction
Exhibit 1040-24	Construction Work Zone and Detour
Exhibit 1040-25	Light Levels and Uniformity Ratios
Exhibit 1050-1	Systems Engineering Process (“V” Diagram)
Exhibit 1050-2	ITS Project Systems Engineering Review Form (With Instructions)

Exhibit 1100-1	Design Matrix Selection Guide
Exhibit 1100-2	Sites With Potential for Improvement
Exhibit 1100-3	NHS Highways in Washington
Exhibit 1100-4	Design Matrix 1: Interstate Routes (Main Line)
Exhibit 1100-5	Design Matrix 2: Interstate Interchange Areas
Exhibit 1100-6	Design Matrix 3: Main Line NHS Routes (Except Interstate)
Exhibit 1100-7	Design Matrix 4: Interchange Areas, NHS (Except Interstate), and Non-NHS
Exhibit 1100-8	Design Matrix 5: Main Line Non-NHS Routes
Exhibit 1100-9	Design Matrix Notes
Exhibit 1110-1	Minor Operational Enhancement Matrix Selection Guide
Exhibit 1110-2	Minor Operational Enhancement Matrix 1: Interstate and NHS Freeway Routes
Exhibit 1110-3	Minor Operational Enhancement Matrix 2: NHS Nonfreeway Routes
Exhibit 1110-4	Minor Operational Enhancement Matrix 3: Non-NHS Routes
Exhibit 1110-5	Q Project Design Summary/Approval Template
Exhibit 1110-6	Refuge Lane for T-Intersections on Two-Lane Highways
Exhibit 1130-1	Desirable Design Speed
Exhibit 1130-2	Stopping Sight Distance: Modified Design Level
Exhibit 1130-3	Minimum Crest Vertical Curve Length: Modified Design Level
Exhibit 1130-4	Minimum Superelevation: Modified Design Level
Exhibit 1130-5	Side Friction Factor
Exhibit 1130-6	One-Way Roadway and Ramp Turning Roadway Widths: Modified Design Level
Exhibit 1130-7	Design Vehicles: Modified Design Level
Exhibit 1130-8	Evaluation for Stopping Sight Distance for Crest Vertical Curves: Modified Design Level
Exhibit 1130-9a	Evaluation for Stopping Sight Distance for Horizontal Curves: Modified Design Level
Exhibit 1130-9b	Evaluation for Stopping Sight Distance Obstruction for Horizontal Curves: Modified Design Level
Exhibit 1130-10	Multilane Highways and Bridges: Modified Design Level
Exhibit 1130-11	Two-Lane Highways and Bridges: Modified Design Level
Exhibit 1130-12a	Minimum Total Roadway Widths for Two-Lane Two-Way Highway Curves: Modified Design Level
Exhibit 1130-12b	Minimum Total Roadway Widths for Two-Lane Two-Way Highway Curves: Modified Design Level, Based on the Delta Angle
Exhibit 1130-13	Main Line Roadway Sections: Modified Design Level
Exhibit 1130-14	Ramp Roadway Sections: Modified Design Level
Exhibit 1140-1	Desirable Design Speed

Exhibit 1140-2	Minimum Shoulder Width
Exhibit 1140-3	Shoulder Width for Curbed Sections in Urban Areas
Exhibit 1140-4	Median Width
Exhibit 1140-5	Geometric Design Data: Interstate
Exhibit 1140-6	Geometric Design Data: Principal Arterial
Exhibit 1140-7	Geometric Design Data: Minor Arterial
Exhibit 1140-8	Geometric Design Data: Collector
Exhibit 1140-9	Geometric Design Data: Urban Managed Access Highways
Exhibit 1210-1	Maximum Angle Without Curve
Exhibit 1210-2a	Alignment Examples
Exhibit 1210-2b	Alignment Examples
Exhibit 1210-2c	Alignment Examples
Exhibit 1220-1	Grade Length
Exhibit 1220-2a	Coordination of Horizontal and Vertical Alignments
Exhibit 1220-2b	Coordination of Horizontal and Vertical Alignments
Exhibit 1220-2c	Coordination of Horizontal and Vertical Alignments
Exhibit 1220-3	Grading at Railroad Crossings
Exhibit 1230-1	Divided Highway Roadway Sections
Exhibit 1230-2	Undivided Multilane Highway Roadway Sections
Exhibit 1230-3	Two-Lane Highway Roadway Sections
Exhibit 1230-4a	Ramp Roadway Sections
Exhibit 1230-4b	Ramp Roadway Sections
Exhibit 1230-5a	Shoulder Details
Exhibit 1230-5b	Shoulder Details
Exhibit 1230-6a	Divided Highway Median Sections
Exhibit 1230-6b	Divided Highway Median Sections
Exhibit 1230-6c	Divided Highway Median Sections
Exhibit 1230-7a	Roadway Sections in Rock Cuts: Design A
Exhibit 1230-7b	Roadway Sections in Rock Cuts: Design B
Exhibit 1230-8	Roadway Sections With Stepped Slopes
Exhibit 1230-9a	Bridge End Slopes
Exhibit 1230-9b	Bridge End Slopes
Exhibit 1240-1a	Traveled Way Width for Two-Lane Two-Way Turning Roadways
Exhibit 1240-1b	Traveled Way Width for Two-Lane Two-Way Turning Roadways: Based on the Delta Angle
Exhibit 1240-2a	Traveled Way Width for Two-Lane One-Way Turning Roadways
Exhibit 1240-2b	Traveled Way Width for Two-Lane One-Way Turning Roadways: Based on the Delta Angle
Exhibit 1240-3a	Traveled Way Width for One-Lane Turning Roadways

Exhibit 1240-3b	Traveled Way Width for One-Lane Turning Roadways: Based on the Delta Angle, Radius on Outside Edge of Traveled Way
Exhibit 1240-3c	Traveled Way Width for One-Lane Turning Roadways: Based on the Delta Angle, Radius on Inside Edge of Traveled Way
Exhibit 1250-1	Minimum Radius for Normal Crown Section
Exhibit 1250-2	Minimum Radius for Existing Curves
Exhibit 1250-3	Side Friction Factor
Exhibit 1250-4a	Superelevation Rates (10% Max)
Exhibit 1250-4b	Superelevation Rates (8% Max)
Exhibit 1250-4c	Superelevation Rates (6% Max)
Exhibit 1250-5	Superelevation Rates for Intersections and Low-Speed Urban Roadways
Exhibit 1250-6a	Superelevation Transitions for Highway Curves
Exhibit 1250-6b	Superelevation Transitions for Highway Curves
Exhibit 1250-6c	Superelevation Transitions for Highway Curves
Exhibit 1250-6d	Superelevation Transitions for Highway Curves
Exhibit 1250-6e	Superelevation Transitions for Highway Curves
Exhibit 1250-7a	Superelevation Transitions for Ramp Curves
Exhibit 1250-7b	Superelevation Transitions for Ramp Curves
Exhibit 1260-1	Design Stopping Sight Distance
Exhibit 1260-2	Stopping Sight Distance: Design Criteria Selection
Exhibit 1260-3	Design Stopping Sight Distance on Grades
Exhibit 1260-4	Stopping Sight Distance on Grades
Exhibit 1260-5	Stopping Sight Distance: Crest Vertical Curves
Exhibit 1260-6	Sight Distance: Crest Vertical Curve
Exhibit 1260-7	Stopping Sight: Distance for Sag Vertical Curves
Exhibit 1260-8	Sight Distance: Sag Vertical Curve
Exhibit 1260-9	Sight Distance Area on Horizontal Curves
Exhibit 1260-10	Horizontal Stopping Sight Distance
Exhibit 1260-11	Sight Distance: Horizontal Curves
Exhibit 1260-12	Stopping Sight Distance: Overlapping Horizontal and Crest Vertical Curves
Exhibit 1260-13	Existing Stopping Sight Distance
Exhibit 1260-14	Passing Sight Distance
Exhibit 1260-15	Passing Sight Distance: Crest Vertical Curves
Exhibit 1260-16	Decision Sight Distance
Exhibit 1270-1	Climbing Lane Example
Exhibit 1270-2a	Speed Reduction Warrant: Performance for Trucks
Exhibit 1270-2b	Speed Reduction Warrant Example
Exhibit 1270-3	Auxiliary Climbing Lane
Exhibit 1270-4	Passing Lane Example

Exhibit 1270-5	Length of Passing Lanes
Exhibit 1270-6	Passing Lane Configurations
Exhibit 1270-7	Buffer Between Opposing Passing Lanes
Exhibit 1270-8	Auxiliary Passing Lane
Exhibit 1270-9	Slow-Moving Vehicle Turnout
Exhibit 1270-10	Emergency Escape Ramp Example
Exhibit 1270-11	Emergency Escape Ramp Length
Exhibit 1270-12	Rolling Resistance (R)
Exhibit 1270-13	Typical Emergency Escape Ramp
Exhibit 1270-14	Chain Up/Chain Off Area
Exhibit 1310-1	Intersection Area
Exhibit 1310-2a	Indirect Left Turns: Signalized Intersections
Exhibit 1310-2b	Indirect Left Turns: Unsignalized Intersections
Exhibit 1310-3	Split Tee Intersections
Exhibit 1310-4	Split Intersections
Exhibit 1310-5	Interchange Ramp Terminal Details
Exhibit 1310-6	Median at Two-Way Ramp Terminal
Exhibit 1310-7	Intersection Balance Example
Exhibit 1310-8	Roundabout at a Two-Way Ramp Terminal
Exhibit 1310-9	Diamond Interchange With Advance Storage
Exhibit 1310-10a	HOV Direct Access: Pavement Markings
Exhibit 1310-10b	HOV Direct Access: Signing
Exhibit 1310-11	Design Vehicle Types
Exhibit 1310-12	Minimum Intersection Design Vehicle
Exhibit 1310-13a	Turning Path Template
Exhibit 1310-13b	Turning Path Template
Exhibit 1310-13c	Turning Path Template
Exhibit 1310-14	Right-Turn Corner
Exhibit 1310-15a	Left-Turn Storage Guidelines: Two-Lane, Unsignalized
Exhibit 1310-15b	Left-Turn Storage Guidelines: Four-Lane, Unsignalized
Exhibit 1310-16a	Left-Turn Storage Length: Two-Lane, Unsignalized
Exhibit 1310-16b	Left-Turn Storage Length: Two-Lane, Unsignalized
Exhibit 1310-16c	Left-Turn Storage Length: Two-Lane, Unsignalized
Exhibit 1310-17	Left-Turn Storage With Trucks (ft)
Exhibit 1310-18a	Median Channelization: Widening
Exhibit 1310-18b	Median Channelization: Median Width 11 ft or More
Exhibit 1310-18c	Median Channelization: Median Width 23 ft to 26 ft
Exhibit 1310-18d	Median Channelization: Median Width of More Than 26 ft

Exhibit 1310-18e	Median Channelization: Minimum Protected Storage
Exhibit 1310-18f	Median Channelization: Two-Way Left-Turn Lane
Exhibit 1310-19	Right-Turn Lane Guidelines
Exhibit 1310-20	Right-Turn Pocket and Right-Turn Taper
Exhibit 1310-21	Right-Turn Lane
Exhibit 1310-22	Acceleration Lane
Exhibit 1310-23a	Traffic Island Designs
Exhibit 1310-23b	Traffic Island Designs: Compound Curve
Exhibit 1310-23c	Traffic Island Designs
Exhibit 1310-24	U-Turn Spacing
Exhibit 1310-25	U-Turn Roadway
Exhibit 1310-26	U-Turn Median Openings
Exhibit 1310-27a	Sight Distance at Intersections
Exhibit 1310-27b	Sight Distance at Intersections
Exhibit 1320-1	Roundabout Elements
Exhibit 1320-2	Entry Angle
Exhibit 1320-3	Turning Radius (R)
Exhibit 1320-4	Mini Roundabout
Exhibit 1320-5	Single-Lane Roundabout
Exhibit 1320-6a	Multilane Roundabout
Exhibit 1320-6b	Multilane Roundabout
Exhibit 1320-6c	Multilane Roundabout
Exhibit 1320-7a	Teardrop Roundabout at Ramp Terminals
Exhibit 1320-7b	Double Teardrop
Exhibit 1320-7c	Teardrop Roundabout With Ramps
Exhibit 1320-8	Initial Ranges
Exhibit 1320-9	Speed vs. Radius
Exhibit 1320-10	Approach Leg Alignment
Exhibit 1320-11	Circulating Roadway Slope
Exhibit 1320-12	Speed vs. Intersection Sight Distance
Exhibit 1320-13a	Design Iteration Steps
Exhibit 1320-13b	Design Iteration Steps
Exhibit 1320-14a	Truck Turning Paths
Exhibit 1320-14b	Truck Turning Paths
Exhibit 1320-15a	Fastest Path Radii
Exhibit 1320-15b	Fastest Path Radii
Exhibit 1320-15c	Fastest Path Radii
Exhibit 1320-16	Consecutive Radii
Exhibit 1320-17	Coinciding Radii and Conflict Points

Exhibit 1320-18	Entry Design Path
Exhibit 1320-19	Entry and Exit Curves
Exhibit 1320-20	Central Island and Cross Section
Exhibit 1320-21	Approach Stopping Sight Distance to Crosswalk
Exhibit 1320-22	Stopping Sight Distance on Circulatory Roadway
Exhibit 1320-23	Exit Stopping Sight Distance to Crosswalk
Exhibit 1320-24	Intersection Sight Distance
Exhibit 1320-25	Landscaping Height Restrictions for Intersection Sight Distance
Exhibit 1320-26	Right-Turn Slip Lane Termination
Exhibit 1320-27	Add and Drop Lanes
Exhibit 1320-28	Railroad Gate Configuration
Exhibit 1320-29	Bicycle Lanes
Exhibit 1320-30	Roundabout Signing
Exhibit 1320-31	Roundabout Striping and Pavement Marking
Exhibit 1320-32	Roundabout Illumination
Exhibit 1320-33a	Multiple Access Circulation
Exhibit 1320-33b	Multiple Access Circulation
Exhibit 1330-1	Responsibility for Facilities
Exhibit 1330-2	Standard Intersection Movements and Head Numbers
Exhibit 1330-3	Phase Diagrams: Four-Way Intersections
Exhibit 1330-4	Left-Turn Lane Configuration Examples
Exhibit 1330-5	Example of Closed Pedestrian Crossings
Exhibit 1330-6a	Vacant
Exhibit 1330-6b	Vacant
Exhibit 1330-7	Decision Zone Loop Placement
Exhibit 1330-8	Loop Numbering Layout
Exhibit 1330-9	Signal Display Maximum Heights
Exhibit 1330-10	Signal Display Areas
Exhibit 1330-11a	Strain Pole and Foundation Selection Procedure
Exhibit 1330-11b	Strain Pole and Foundation Selection Procedure
Exhibit 1330-12	Strain Pole and Foundation Selection Example
Exhibit 1330-13	Conduit and Conductor Sizes
Exhibit 1330-14a	Traffic Signal Display Placements
Exhibit 1330-14b	Traffic Signal Display Placements
Exhibit 1330-14c	Traffic Signal Display Placements
Exhibit 1330-14d	Traffic Signal Display Placements
Exhibit 1330-14e	Traffic Signal Display Placements
Exhibit 1330-14f	Traffic Signal Display Placements
Exhibit 1340-1	Road Approach Design Templates

Exhibit 1340-2	Road Approach Access Category
Exhibit 1340-3	Road Approach Design Template A1
Exhibit 1340-4	Road Approach Design Templates B1 and C1
Exhibit 1340-5	Road Approach Design Template D1
Exhibit 1340-6	Road Approach Sight Distance
Exhibit 1350-1	Sight Distance at Railroad Crossing
Exhibit 1350-2	Typical Pullout Lane at Railroad Crossing
Exhibit 1360-1	Basic Interchange Patterns
Exhibit 1360-2	Interchange Spacing
Exhibit 1360-3	Minimum Ramp Connection Spacing
Exhibit 1360-4	Ramp Design Speed
Exhibit 1360-5	Maximum Ramp Grade
Exhibit 1360-6	Ramp Widths
Exhibit 1360-7a	Lane Balance
Exhibit 1360-7b	Lane Balance
Exhibit 1360-8	Main Line Lane Reduction Alternatives
Exhibit 1360-9	Acceleration Lane Length
Exhibit 1360-10	Deceleration Lane Length
Exhibit 1360-11a	Gore Area Characteristics
Exhibit 1360-11b	Gore Area Characteristics
Exhibit 1360-12	Length of Weaving Sections
Exhibit 1360-13a	On-Connection: Single-Lane, Tapered
Exhibit 1360-13b	On-Connection: Single-Lane, Parallel
Exhibit 1360-13c	On-Connection: Two-Lane, Parallel
Exhibit 1360-13d	On-Connection: Two-Lane, Tapered
Exhibit 1360-14a	Off-Connection: Single-Lane, Tapered
Exhibit 1360-14b	Off-Connection: Single-Lane, Parallel
Exhibit 1360-14c	Off-Connection: Single-Lane, One-Lane Reduction
Exhibit 1360-14d	Off-Connection: Two-Lane, Tapered
Exhibit 1360-14e	Off-Connection: Two-Lane, Parallel
Exhibit 1360-15a	Collector-Distributor: Outer Separations
Exhibit 1360-15b	Collector Distributor: Off-Connections
Exhibit 1360-15c	Collector Distributor: On-Connections
Exhibit 1360-16	Loop Ramp Connections
Exhibit 1360-17	Temporary Ramps
Exhibit 1360-18	Interchange Plan
Exhibit 1410-1	Minimum Traveled Way Widths for Articulated Buses
Exhibit 1410-2	Typical HOV Lane Sections
Exhibit 1410-3	Roadway Widths for Two-Lane Ramps With an HOV Lane

Exhibit 1410-4a	Single-Lane Ramp Meter With HOV Bypass
Exhibit 1410-4b	Two-Lane Ramp Meter With HOV Bypass
Exhibit 1410-5a	Enforcement Area: One Direction Only
Exhibit 1410-5b	Enforcement Area: Median
Exhibit 1420-1	Minimum Ramp Widths for Articulated Buses
Exhibit 1420-2	Gap Acceptance Length for Parallel On-Connections
Exhibit 1420-3	Drop Ramp
Exhibit 1420-4	T Ramp
Exhibit 1420-5	Flyover Ramp
Exhibit 1420-6	Side Platform Flyer Stop
Exhibit 1420-7	At-Grade Crossing Flyer Stop
Exhibit 1420-8	Transit Stops at Ramps
Exhibit 1420-9	Other Transit Stops
Exhibit 1420-10	Single-Lane Parallel On-Connection
Exhibit 1420-11	HOV Direct Access Acceleration Lane Length
Exhibit 1420-12	Single-Lane Parallel Off-Connection
Exhibit 1420-13	Drop Ramp Gore Area Characteristics
Exhibit 1420-14	Deceleration Lane Length for Buses
Exhibit 1420-15	T Ramp Design
Exhibit 1420-16	Flyer Stop Signing
Exhibit 1420-17	HOV Direct Access Signing: Main Line
Exhibit 1420-18	HOV Direct Access Signing: Local Street and Ramp Terminal
Exhibit 1420-19	HOV Direct Access Overhead Signs
Exhibit 1420-20	HOV Direct Access Shoulder-Mounted Signs
Exhibit 1430-1	Bus Berth Designs
Exhibit 1430-2	Transit Center Sawtooth Bus Berth
Exhibit 1430-3	Bus Turnout Transfer Center
Exhibit 1430-4	Off-Street Transfer Center
Exhibit 1430-5	Minimum Bus Zone Dimensions
Exhibit 1430-6	Bus Stop Pullouts: Arterial Streets
Exhibit 1430-7	Minimum Bus Zone and Pullout After Right-Turn Dimensions
Exhibit 1430-8	Shelter Siting
Exhibit 1430-9	Typical Bus Shelter Design
Exhibit 1430-10	Turning Template for a 40-Foot Bus
Exhibit 1430-11	Turning Template for an Articulated Bus
Exhibit 1430-12	Intersection Design
Exhibit 1430-13	Cross-Street Width Occupied by Turning Vehicle for Various Angles of Intersection and Curb Radii
Exhibit 1430-14	Passenger Loading Pad

Exhibit 1510-1	Pedestrian Circulation Paths
Exhibit 1510-2	Relationship Between Pedestrian Circulation Paths and Pedestrian Access Routes
Exhibit 1510-3	Obstructed Pedestrian Access Route
Exhibit 1510-4	Surface Discontinuities (Noncompliant)
Exhibit 1510-5	Sidewalks With Buffers
Exhibit 1510-6	Typical Sidewalk Designs
Exhibit 1510-7	Typical Driveways
Exhibit 1510-8	Perpendicular Curb Ramp
Exhibit 1510-9	Perpendicular Curb Ramp Common Elements
Exhibit 1510-10	Parallel Curb Ramp
Exhibit 1510-11	Parallel Curb Ramp Common Elements
Exhibit 1510-12	Combination Curb Ramp
Exhibit 1510-13	Typical Curb Ramp Drainage
Exhibit 1510-14	Unmarked Crosswalks
Exhibit 1510-15	Marked Pedestrian Crossing
Exhibit 1510-16	Example of Closed Pedestrian Crossing
Exhibit 1510-17	Midblock Pedestrian Crossing
Exhibit 1510-18	Obstructed Line of Sight at Intersection
Exhibit 1510-19	Improved Line of Sight at Intersection
Exhibit 1510-20	Curb Extension Examples
Exhibit 1510-21	Raised Islands With Curb Ramps and Pedestrian Cut-Throughs
Exhibit 1510-22	Pedestrian Railroad Crossings
Exhibit 1510-23	Pedestrian Railroad Warning Device
Exhibit 1510-24	Pedestrian Bridges
Exhibit 1510-25	Pedestrian Tunnel
Exhibit 1510-26	Access Ramp With Accessible Handrails
Exhibit 1510-27	Work Zones and Pedestrian Facilities
Exhibit 1510-28	Crosswalk Marking and Enhancement Guidelines
Exhibit 1515-1	Shared-Use Path
Exhibit 1515-2	Bicycle Design Speeds
Exhibit 1515-3	Two-Way Shared-Use Path: Independent Alignment
Exhibit 1515-4	Two-Way Shared-Use Path: Adjacent to Roadway
Exhibit 1515-5	Shared-Use Path Landings Profile
Exhibit 1515-6	Shared-Use Path Landing and Rest Area
Exhibit 1515-7	Shared-Use Path Curve Widening
Exhibit 1515-8	Typical Redesign of a Diagonal Midblock Crossing
Exhibit 1515-9	Adjacent Shared-Use Path Intersection
Exhibit 1515-10	Refuge Area
Exhibit 1515-11	Barrier Adjacent to Shared-Use Path

Exhibit 1515-12	Stopping Sight Distance
Exhibit 1515-13	Sight Distances for Vertical Curves
Exhibit 1515-14	Lateral Clearance on Horizontal Curves
Exhibit 1520-1	Bike Facility Selection
Exhibit 1520-2	Shared Roadway
Exhibit 1520-3	Signed Shared Roadway: Designated Bike Route
Exhibit 1520-4	Bike Lane
Exhibit 1520-5	Typical Urban Bike Lane Cross Sections
Exhibit 1520-6	Typical Bicycle/Auto Movements at Intersection of Multilane Streets
Exhibit 1520-7	Bike Lanes Approaching Motorists' Right-Turn-Only Lanes
Exhibit 1520-8a	Bicycle Crossing of Interchange Ramp
Exhibit 1520-8b	Bicycle Crossing of Interchange Ramp
Exhibit 1520-9	At-Grade Railroad Crossings
Exhibit 1520-10	Barrier Adjacent to Bicycle Facilities
Exhibit 1600-1	Design Clear Zone Distance Table
Exhibit 1600-2	Design Clear Zone Inventory Form (# 410-026 EF)
Exhibit 1600-3	Recovery Area
Exhibit 1600-4	Design Clear Zone for Ditch Sections
Exhibit 1600-5	Guidelines for Embankment Barrier
Exhibit 1600-6	Mailbox Location and Turnout Design
Exhibit 1600-7	Glare Screens
Exhibit 1610-1	Type 7 Bridge Rail Upgrade Criteria
Exhibit 1610-2	Longitudinal Barrier Deflection
Exhibit 1610-3	Longitudinal Barrier Flare Rates
Exhibit 1610-4	Traffic Barrier Locations on Slopes
Exhibit 1610-5	Old Type 3 Anchor
Exhibit 1610-6	Guardrail Connections
Exhibit 1610-7	Concrete Barrier Shapes
Exhibit 1610-8	Concrete Barrier Placement Guidance: Assessing Impacts to Wildlife
Exhibit 1610-9	Transitions and Connections
Exhibit 1610-10a	Barrier Length of Need on Tangent Sections
Exhibit 1610-10b	Barrier Length of Need
Exhibit 1610-10c	Barrier Length of Need on Curves
Exhibit 1610-10d	W-Beam Guardrail Trailing End Placement for Divided Highways
Exhibit 1610-11	Beam Guardrail Post Installation
Exhibit 1610-12a	Beam Guardrail Terminals
Exhibit 1610-12b	Beam Guardrail Terminals
Exhibit 1610-13a	Cable Barrier Locations on Median Slopes
Exhibit 1610-13b	Cable Barrier Locations on Shoulder Slopes

Exhibit 1610-13c	Cable Barrier Placement for Divided Highways
Exhibit 1610-14	Thrie Beam Rail Retrofit Criteria
Exhibit 1620-1	Impact Attenuator Sizes
Exhibit 1620-2a	Impact Attenuator Systems: Permanent Installations
Exhibit 1620-2b	Impact Attenuator Systems: Permanent Installations
Exhibit 1620-2c	Impact Attenuator Systems: Permanent Installations
Exhibit 1620-2d	Impact Attenuator Systems: Permanent Installations
Exhibit 1620-2e	Impact Attenuator Systems: Permanent Installations
Exhibit 1620-3a	Impact Attenuator Systems: Work Zone Installations
Exhibit 1620-3b	Impact Attenuator Systems: Work Zone Installations
Exhibit 1620-4a	Impact Attenuator Systems: Older Systems
Exhibit 1620-4b	Impact Attenuator Systems: Older Systems
Exhibit 1620-5	Impact Attenuator System Comparison
Exhibit 1620-6	Impact Attenuator Distance Beyond Length of Need
Exhibit 1710-1	Typical Truck Storage
Exhibit 1710-2	Typical Single RV Dump Station Layout
Exhibit 1710-3	Typical Two RV Dump Station Layout
Exhibit 1720-1	Truck Weigh Site: Multilane Highways
Exhibit 1720-2	Truck Weigh Site: Two-Lane Highways
Exhibit 1720-3	Vehicle Inspection Installation
Exhibit 1720-4	Minor Portable Scale Site
Exhibit 1720-5	Major Portable Scale Site
Exhibit 1720-6	Small Shoulder Site
Exhibit 1720-7	Large Shoulder Site
Exhibit 1720-8	MOU Related to Vehicle Weighing and Equipment: Inspection Facilities on State Highways

subprogram might provide sufficient information to identify the Project Type. (See the *Programming Manual* for details about budget programs and subprograms.)

The various sources of funds for these subprograms carry eligibility requirements that the designers and project developers must identify and monitor throughout project development. This is especially important to ensure accuracy when writing agreements and to avoid delaying advertisement for bids if the Project Type changes.

Some projects involve work from several subprograms. In such cases, identify the various limits of the project that apply to each subprogram. Where the project limits overlap, apply the higher design level to the overlapping portion.

Project Types (in alphabetical order) are:

At Grade: Safety Improvement projects on NHS highways (45 mph or higher) to build grade-separation facilities that replace the existing intersections.

Bike Routes (Shldrs): Main line economic development Improvement projects to provide a statewide network of rural bicycle touring routes with shoulders a minimum of 4 feet wide.

Bike/Ped. Connectivity: Improvement projects to provide bicycle/pedestrian connections, along or across state highways within urban growth areas, to complete local networks.

Bridge Deck Rehab: Structures Preservation projects that repair delaminated bridge decks and add protective overlays to provide a sound, smooth surface, prevent further corrosion of the reinforcing steel, and preserve operational and structural integrity.

Bridge Rail Upgrades: Safety Improvement projects to update older bridge rails to improve strength and redirection capabilities.

Bridge Repl. (Multilane): Non-NHS main line structures Preservation projects that replace bridges on multilane highways to improve operational and structural capacity.

Bridge Replacement: NHS and two-lane non-NHS (main line and interchange) structures Preservation projects that replace bridges to improve operational and structural capacity.

Bridge Restrictions: Main line economic development Improvement projects that remove vertical or load capacity restrictions to benefit the movement of commerce.

BST: Non-NHS roadway Preservation projects to do bituminous surface treatment (BST) work only, to protect the public investment.

BST Routes/Basic Safety: Non-NHS roadway Preservation projects that resurface highways at regular intervals and restore existing safety features, to protect the public investment.

Collision Analysis Locations (CALs): Sites identified through a system-wide analysis that have a high-severity collision history. These sites are created with the intent to modify, where appropriate, specific highway elements that have a greater potential to reduce the identified high-severity collisions.

Corridor: Main line Improvement projects to reduce and prevent vehicular, nonmotorized, and pedestrian collisions (within available resources).

Diamond Grinding: Grinding a concrete pavement, using gang-mounted diamond saw blades, to remove surface wear or joint faulting.

Dowel Bar Retrofit: Reestablishing the load transfer efficiencies of the existing concrete joints and transverse cracks by cutting slots, placing epoxy-coated dowel bars, and placing high-early strength nonshrink concrete.

Four-Lane Trunk System: NHS economic development Improvement projects to complete contiguous four-lane limited access facilities on a trunk system consisting of all Freight and Goods Transportation Routes (FGTS) with a classification of 10,000,000 tons/year.

Freight & Goods (Frost Free): Main line economic development Improvement projects to reduce delay from weather-related closures on high-priority freight and goods highways.

Guardrail Upgrades: Safety Improvement projects limited to the specified roadside design elements. These projects focus on W-beam with 12-foot-6-inch spacing and on guardrail systems with concrete posts. The length of need is examined and minor adjustments are made. Removal is an option if guardrail is no longer needed. For Interstate main line, address length of need as specified in Chapter 1610. For non-Interstate routes, additional length of more than 5% of the existing length is beyond the intent of this program. In these instances, consider funding in accordance with priority programming instructions and, if the length of need is not met, document to the Design Documentation Package (DDP) that the length of need is not addressed because it is beyond the intent of this program.

HMA/PCCP: Non-NHS roadway Preservation projects to resurface highways at regular intervals and restore existing safety features to protect the public investment.

HMA/PCCP/BST Overlays: NHS main line roadway Preservation projects that resurface the existing surfaces at regular intervals to protect the public investment.

HMA/PCCP/BST Overlays Ramps: NHS and non-NHS ramp roadway Preservation projects that resurface the existing surfaces at regular intervals and restore existing safety features to protect the public investment.

HMA Structural Overlays: Hot mix asphalt overlays that are placed to increase the load-carrying ability of the pavement structure. Structural overlay thickness is greater than 0.15 foot.

HOV: Main line mobility Improvement projects completing the freeway Core HOV lane system in the Puget Sound region and providing level of service C on HOV lanes (including business access transit lanes) within congested highway corridors.

HOV Bypass: NHS and non-NHS ramp mobility Improvement projects to improve mobility within congested highway corridors by providing HOV bypass lanes on freeway ramps. Congested highway corridors have high congestion index values as described in the Highway System Plan (footnote in text for Improvement/Mobility).

Intersection: Safety Improvement projects to reduce and prevent collisions, increase the safety of highways, and improve pedestrian safety (within available resources).

Median Barrier: Limited safety Improvement projects: mainly new median barrier, with a focus on cable barrier, to reduce median crossover collisions.

Milling with HMA Inlays: Removing a specified thickness of the existing HMA pavement, typically from the traveled lanes, and then overlaying with HMA at the same specified thickness.

New/Reconstruction projects include the following types of work:

- Capacity changes: add a through lane, convert a general-purpose (GP) lane to a special-purpose lane (such as an HOV lane), or convert a high-occupancy vehicle (HOV) lane to GP.
- Other lane changes: add or eliminate a collector-distributor or auxiliary lane (a rural truck-climbing lane that, for its entire length, meets the warrants in Chapter 1270 is not considered new/reconstruction).
- Pavement reconstruction: full depth PCCP or HMA replacement.
- New interchange.
- Changes in interchange type such as diamond to directional or adding a ramp.
- New or replacement bridge (on or over, main line or interchange ramp).

Non-Interstate Freeway (mobility): On non-NHS and NHS interchanges and on NHS main line, these are mobility Improvement projects on multilane divided highways with limited access control within congested highway corridors.

Non-Interstate Freeway (roadway preservation): Roadway Preservation projects on non-NHS and NHS interchanges and on NHS main line, to overlay or inlay with HMA/PCCP/BST on multilane divided highways with limited access control to minimize long-term costs and restore existing safety features.

Non-Interstate Freeway (safety): NHS and non-NHS (main line and interchanges) safety Improvement projects on multilane divided highways with limited access control to increase the safety within available resources.

Nonstructural Overlay: An HMA pavement overlay that is placed to minimize the aging effects and minor surface irregularities of the existing HMA pavement structure. The existing HMA pavement structure is not showing extensive signs of fatigue (longitudinal or alligator cracking in the wheel paths). Nonstructural overlays are less than or equal to 0.15-foot thick and frequently less than 0.12-foot thick.

PCCP Overlays: Portland cement concrete pavement overlays of existing PCCP or HMA surfaces.

Preventive Maintenance: Includes roadway work such as pavement patching, restoration of drainage system, panel replacement, and joint and shoulder repair, and bridge work such as crack sealing, joint repair, slope stabilization, seismic retrofit, scour countermeasures, and painting. Preventive maintenance projects must not degrade any existing safety or geometric aspects of the facility. Any elements that will be reconstructed as part of a preventive maintenance project are to be addressed in accordance with full design level.

Replace HMA w/PCCP at I/S (intersections): NHS and non-NHS main line roadway Preservation projects that restore existing safety features and replace existing HMA intersection pavement that has reached the point of lowest life cycle cost (11–15 years old) with PCCP that has about a 40-year life cycle.

Rest Areas (New): NHS and non-NHS main line economic development and safety Improvement projects to provide rest areas every 60 miles and some RV dump stations.

Risk: Realignment: Improvement projects intended to improve alignment at specific locations where the Risk program has identified a high probability of collisions.

Risk: Roadside: Improvement projects intended to mitigate roadside conditions at specific locations where the Risk program has identified a high probability of vehicular encroachment.

Risk: Roadway Width: Improvement projects intended to adjust the roadway width at specific locations where the Risk program has identified a high probability of a vehicle leaving its lane of travel.

Risk: Sight Distance: Improvement projects intended to improve sight distance at specific locations where the Risk program has identified a high probability of collisions.

Rural: Mobility Improvement projects providing uncongested level of service on rural highways within congested highway corridors. (See HOV Bypass for cross reference regarding “congested.”)

Urban: NHS and two-lane non-NHS (main line and interchange) mobility Improvement projects within congested urban highway corridors. (See HOV Bypass for cross reference regarding “congested.”)

Urban (multilane): Non-NHS mobility Improvement projects within congested urban multilane highway corridors. (See HOV Bypass for cross reference regarding “congested.”)

(2) Design Elements

The column headings on a design matrix are **Design Elements**. Not all potential design elements have been included in the matrices.

The design elements that are included are based on the following thirteen Federal Highway Administration (FHWA) controlling design criteria: design speed, lane width, shoulder width, bridge width, structural capacity, horizontal alignment, vertical alignment, grade, stopping sight distance, cross slope, superelevation, vertical clearance, and horizontal clearance. For the column headings, some of these controlling criteria have been combined (for example, design speed is part of horizontal and vertical alignment).

If using a design element that is not on the assigned matrix, use full design level as found elsewhere in this manual.

If using a design element that is not covered in this manual, use an approved manual or guidance on the subject and document the decision and the basis for the decision.

The following elements are shown on the design matrices. If the full design level applies, see the chapters listed below. If the basic design level applies, see Chapter 1120, and if the modified design level applies, see Chapter 1130.

Horizontal Alignment: The horizontal attributes of the roadway, including horizontal curvature, superelevation, and stopping sight distance: all based on design speed. (See Chapter 1210 for horizontal alignment, Chapter 1250 for superelevation, Chapter 1260 for stopping sight distance, and Chapters 1140 or 1360 for design speed.)

Vertical Alignment: The vertical attributes of the roadway, including vertical curvature, profile grades, and stopping sight distance: all based on design speed. (See Chapter 630 for vertical alignment, Chapters 1130, 1140, 1220, and 1360 for grades, Chapters 1130 and 1260 for stopping sight distance, and Chapters 1130, 1140, or 1360 for design speed.)

Lane Width: Defined in Chapter 1140 (also see Chapters 1130, 1230, 1240, and 1360).

Shoulder Width: Defined in Chapter 1140 (also see Chapters 1130, 1230, and 1360). For shy distance requirements when barrier is present, see Chapter 1610.

Lane Transitions (pavement transitions): The rate and length of transition of changes in width of lanes (see Chapter 1210).

On/Off Connection: The widened portion of pavement at the end of a ramp connecting to a main lane of a freeway (see Chapter 1360).

Median Width: The distance between inside edge lines (see Chapters 1140 and 1230).

Cross Slope: Lane: The rate of elevation change across a lane. This element includes the algebraic difference in cross slope between adjacent lanes (see Chapters 1130 and 1230).

Cross Slope: Shoulder: The rate of elevation change across a shoulder (see Chapters 1130 and 1230).

Fill/Ditch Slopes: The downward slope from edge of shoulder to bottom of ditch or catch (see Chapters 1130 and 1230).

Access: The means of entering or leaving a public road, street, or highway with respect to abutting private property or another public road, street, or highway (see Chapter 520).

Clear Zone: The total roadside border area, starting at the edge of the traveled way, available for use by errant vehicles. This area may consist of a shoulder, a recoverable slope, a nonrecoverable slope, and/or a clear run-out area. The median is part of a clear zone (see Chapter 1600).

Signing, Delineation, Illumination, ITS: Signs, guideposts, pavement markings, lighting, and intelligent transportation systems equipment. (See Chapters 720 for bridge signs and 1020 for signing, Chapter 1030 for delineation, Chapter 1040 for illumination, and Chapter 1050 for ITS.)

Vertical Clearance: Defined in Chapter 720.

Basic Safety: The list of safety items is in Chapter 1120.

Bicycle and Pedestrian: Defined in Chapter 1510, Pedestrian Design Considerations, Chapter 1515, Shared-Use Paths, and Chapter 1520, Roadway Bicycle Facilities.

Bridges: Lane Width: The width of a lane on a structure (see Chapters 720, 1130, 1140, 1230, 1240, and 1360).

Bridges: Shoulder Width: The distance between the edge of traveled way and the face of curb or barrier, whichever is less (see Chapters 720, 1130, 1140, 1230, and 1360; also see Chapter 1610 for shy distance requirements).

Bridges/Roadway: Vertical Clearance: The minimum height between the roadway, including shoulder, and an overhead obstruction (see Chapter 720).

Bridges: Structural Capacity: The load-bearing ability of a structure (see Chapter 720).

Intersections/Ramp Terminals: Turn Radii: Defined in Chapter 1310.

Intersections/Ramp Terminals: Angle: Defined in Chapter 1310.

Intersections/Ramp Terminals: Intersection Sight Distance: Defined in Chapter 1310, Intersections at Grade, and Chapter 1360, Interchanges.

Barriers: Terminals and Transition Sections:

- Terminals: Crashworthy end treatments for longitudinal barriers that are designed to reduce the potential for spearing, vaulting, rolling, or excessive deceleration of impacting vehicles from either direction of travel. Impact attenuators are considered terminals. Beam guardrail terminals include anchorage.
- Transition Sections: Sections of barriers used to produce a gradual stiffening of a flexible or semirigid barrier as it connects to a more rigid barrier or fixed object (see Chapters 1600, 1610, and 1620).

Barriers: Standard Run: Guardrail and other barriers as shown in the *Standard Plans for Road Bridge and Municipal Construction*, excluding terminals, transitions, attenuators, and bridge rails (see Chapter 1610).

Barriers: Bridge Rail: Barrier on a bridge, excluding transitions (see Chapter 1610).

(3) Design Level

In the non-Interstate matrices, design levels are noted in the cells by B, M, F, and sometimes with a number corresponding to a footnote on the matrix. For Improvement projects, full design level applies to all design elements except as noted in the design matrices and in other chapters as applicable. In the Interstate matrices, only full design level applies.

The design levels of basic, modified, and full (B, M, and F) were used to develop the design matrices. Each design level is based on the investment intended for the highway system and Project Type. (For example, the investment is greater for an Interstate overlay than for an overlay on a non-NHS route.)

(a) **Blank Cell**

A blank cell in a design matrix row signifies that the design element will not be addressed because it is beyond the scope of the typical project. In rare instances, a design element with a blank cell may be included if that element is linked to the original need that generated the project and is identified in the Project Summary or a Project Change Request Form.

(b) **Basic Design Level (B)**

Basic design level preserves pavement structures, extends pavement service life, and maintains safe highway operations. (See Chapter 1120 for design guidance.)

(c) **Modified Design Level (M)**

Modified design level preserves and improves existing roadway geometrics, safety, and operational elements. (See Chapter 1130 for design guidance.) Use full design level for design elements or portions of design elements that are not covered in Chapter 1130.

(d) **Full Design Level (F)**

Full design level improves roadway geometrics, safety, and operational elements. (See Chapter 1140 and other applicable *Design Manual* chapters for design guidance.)

↓ Project Type	Main Line														Bridges ^[11]				Intersections			Barriers			
	Horizontal Alignment	Vertical Alignment	Lane Width	Shoulder Width	Lane Transition	On / Off Connection	Median Width	Cross Slope Lane	Cross Slope Shoulder	Fill / Ditch Slopes	Access ^[3]	Clear Zone ^[18]	Sign., Del., Illum., & ITS	Basic Safety	Bike & Ped.	Lane Width	Shoulder Width	Vertical Clearance	Structural Capacity	Turn Radii	Angle	I/S Sight Distance	Term. & Trans. Section ^[12]	Standard Run	Bridge Rail ^{[14] [19]}
Preservation																									
Roadway																									
(3-1) Non-Interstate Freeway	DE/F	DE/F	DE/F	DE/F	DE/F	DE/F	DE/F	DE/F	DE/F	DE/F	DE/F	[28]	[28]	B		DE/F	DE/F	F				[28]	F	[28]	F
(3-2) HMA/PCCP/BST Overlays	DE/M	DE/M	DE/M	DE/M	DE/F	DE/F	DE/M	DE/M	DE/M	DE/M	DE/M	[28]	[28]	B	M	DE/M	DE/M	F				[28]	F	[28]	F
(3-3) Replace HMA w/PCCP at I/S	DE/M	DE/M	EU/M	EU/M	DE/F		DE/M	EU/M	DE/M	DE/M	DE/M	[28]	[28]	B	M	DE/M	DE/M	F				[28]	F	[28]	F
Structures																									
(3-4) Bridge Replacement	F ^[2]	F ^[2]	F ^[2]	F ^[2]	F	F ^[2]	F ^[2]	F ^[2]	F ^[2]	F ^[2]		F	F		F	F ^[2]	F ^[2]	F	F	F ^[2]	F ^[2]	F	F	F	F
(3-5) Bridge Deck Rehab.												[28]	[28]	B	M			F				[28]	F ^[6]	F ^[22]	F
Improvements^[16]																									
Mobility																									
(3-6) Non-Interstate Freeway	F	F	F	F	F	F	F	F	F	F	F	F	F		F	F	F	F	F	F	F	F	F	F	F
(3-7) Urban	F ^[2]	F ^[2]	F ^[2]	F ^[2]	F	F ^[2]	F ^[2]	F ^[2]	F ^[2]	F ^[2]	F	F	F		F	F ^[2]	F ^[2]	F	F	F ^[2]	F ^[2]	F	F	F	F
(3-8) Rural	F ^[2]	F ^[2]	F ^[2]	F ^[2]	F	F ^[2]	F ^[2]	F ^[2]	F ^[2]	F ^[2]	F	F	F		F	F ^[2]	F ^[2]	F	F	F ^[2]	F ^[2]	F	F	F	F
(3-9) HOV	F ^[2]	F ^[2]	F ^[2]	F ^[2]	F	F ^[2]	F ^[2]	F ^[2]	F ^[2]	F ^[2]	F	F	F		F	F ^[2]	F ^[2]	F	F	F ^[2]	F ^[2]	F	F	F	F
(3-10) Bike/Ped. Connectivity	[5]	[5]	[5]	[5]	[5]			[5]	[5]	[5]	[5]	[5]	[5]		F	[5]	[5]	[5]	[5]	[5]	[5]	[5]	[5]	[5]	[5]
Safety																									
(3-11) Non-Interstate Freeway	F	F	F	F	F	F	F	F	F	F	F	F	F		F	F	F	F		F	F	F	F	F	F
(3-12) Intersection ^[1]			F ^[2]	F ^[2]	F					F ^[2]	F	F	F		M					F	F	F	F	F	F
(3-13) Corridor ^{[1][24]}	M ^[4]	M ^[4]	M ^[4]	M ^[4]	F	F ^[17]	M ^[4]	M ^[4]	M ^[4]	M ^[4]	F	F	F		F	M ^[4]	M ^[4]	F		M ^[4]	M ^[4]	F	F	F	F
(3-14) Median Barrier				DE/F																			F ^[20]	F ^[20]	
(3-15) Guardrail Upgrades				DE/F																			F	F ^[23]	
(3-16) Bridge Rail Upgrades																							F	F ^[22]	F
(3-17) Risk: Roadside										F	EU/F	F	F										F	F	F
(3-18) Risk: Sight Distance	F/M ^[21]	F/M ^[21]	F/M ^[21]	F/M ^[21]						F/M ^[21]	F ^[21]	F ^[21]	F		F	F ^[21]	F ^[21]	F ^[21]		F/M ^[21]	F/M ^[21]	F ^[21]	F	F	F
(3-19) Risk: Roadway Width			F/M ^[21]	F/M ^[21]	F ^[21]	F ^[21]	F/M ^[21]	F/M ^[21]	F/M ^[21]	F/M ^[21]	F	F	F		F	F ^[21]	F ^[21]	F ^[21]		F/M ^[21]	F/M ^[21]	F ^[21]	F	F	F
(3-20) Risk: Realignment	F ^[2]	F ^[2]	F ^[2]	F ^[2]	F	F ^[2]	F ^[2]	F ^[2]	F ^[2]	F ^[2]	F	F	F		F	F ^[2]	F ^[2]	F		F ^[2]	F ^[2]	F ^[2]	F	F	F
(3-21) Collision Analysis Locations	Design Elements determined based on a Project Analysis ^[27]																								
Economic Development																									
(3-22) Freight & Goods (Frost Free) ^[8]	F ^[2]	F ^[2]	F ^[2]	F ^[2]	F	F ^[2]	F ^[2]	F ^[2]	F ^[2]	F ^[2]	EU/F	F	F		EU/F ^[26]	DE/F	DE/F	F	F	EU/F	EU/F	EU/F	F	F	F
(3-23) Four-Lane Trunk System	F	F	F	F	F	F	F	F	F	F	F	F	F		F	F	F	F	F	F	F	F	F	F	F
(3-24) Rest Areas (New)	F	F	F	F	F	F	F	F	F	F	F	F	F		F	F	F	F		F	F	F	F	F	F
(3-25) Bridge Restrictions	F ^[2]	F ^[2]	F ^[2]	F ^[2]	F	F ^[2]	F ^[2]	F ^[2]	F ^[2]	F ^[2]		F	F		EU/F ^[26]	F ^[2]	F ^[2]	F	F	F ^[2]	F ^[2]	F	F	F	F
(3-26) Bike Routes (Shldrs)			EU/M	[7]	EU/F				EU/M	EU/M		[28]	[28]	B	F	EU/M	EU/M	F				[28]	F	[28]	EU/F

Design Matrix 3: Main Line NHS Routes (Except Interstate)
Exhibit 1100-6

↓ Project Type	Ramps and Collector-Distributors															Crossroad																	
	Horizontal Alignment	Vertical Alignment	Lane Width	Shoulder Width	Lane Transition	On / Off Connection	Cross Slope Lane	Cross Slope Shoulder	Fill / Ditch Slopes	Access ^[3]	Clear Zone	Sign., Del., Illum., & ITS	Basic Safety	Bike & Ped	Ramp Terminals			Barriers					Lane Width	Shoulder Width	Fill / Ditch Slopes	Access ^[3]	Clear Zone	Sign., Del., Illum., & ITS	Basic Safety	Vertical Clearance ^[11]	Ped. & Bike	Barriers	
Turn Radii															Angle	I/S Sight Distance	Term. & Trans. Section ^[12]	Standard Run	Bridge Rail ^[14] ^[19]	Term. & Trans. Section ^[12]	Standard Run	Bridge Rail ^[14] ^[19]											
Preservation																																	
Roadway																																	
(4-1) Non-Interstate Freeway	DE/F	DE/F	DE/F	DE/F	DE/F	DE/F	DE/F	DE/F	DE/F	DE/F	[28]	[28]	B	M	DE/F	DE/F	DE/F	F	[28]	F	DE/F	DE/F	DE/F		[28]	[28]	B	F	M	F	[28]	F	
(4-2) HMA/PCCP/BST Overlay Ramps											[28]	[28]	B	M			[28]	F	[28]	F					[28]	[28]	B	F	M	F	[28]	F	
Structures																																	
(4-3) Bridge Replacement	F ^[2]	F ^[2]	F ^[2]	F ^[2]	F	F ^[2]	F ^[2]	F ^[2]	F ^[2]	F	F	F		F	F	F	F	F	F	F	F ^[2]	F ^[2]	F ^[2]	F	F	F		F	F	F	F	F	
(4-4) Bridge Deck Rehab.											[28]	[28]	B	M			[28]	F ^[6]	F ^[22]	F					[28]	[28]	B	F	M	F ^[6]	F ^[22]	F	
Improvements ^[16]																																	
Mobility																																	
(4-5) Non-Interstate Freeway	F	F	F	F	F	F	F	F	F	F	F	F		F	F	F	F	F	F	F	F	F	F	F	F	F		F	F	F	F	F	
(4-6) Urban	F ^[2]	F ^[2]	F ^[2]	F ^[2]	F	F ^[2]	F ^[2]	F ^[2]	F ^[2]	F	F	F		F	F ^[2]	F ^[2]	F	F	F	F	F ^[2]	F ^[2]	F ^[2]	F	F	F		F	F	F	F	F	
(4-7) Rural	F ^[2]	F ^[2]	F ^[2]	F ^[2]	F	F ^[2]	F ^[2]	F ^[2]	F ^[2]	F	F	F		F	F ^[2]	F ^[2]	F	F	F	F	F ^[2]	F ^[2]	F ^[2]	F	F	F		F	F	F	F	F	
(4-8) HOV Bypass	F ^[2]	F ^[2]	F ^[2]	F ^[2]	F	F ^[2]	F ^[2]	F ^[2]	F ^[2]	F	F	F		F	F ^[2]	F ^[2]	F	F	F	F	F ^[2]	F ^[2]	F ^[2]	F	F	F		F	F	F	F	F	
(4-9) Bike/Ped. Connectivity	[5]	[5]	[5]	[5]	[5]		[5]	[5]	[5]	[5]	[5]	[5]		F	[5]	[5]	[5]	[5]	[5]	[5]	[5]	[5]	[5]			[5]		[5]	F	[5]	[5]	[5]	
Safety																																	
(4-10) Non-Interstate Freeway	F	F	F	F	F	F	F	F	F	F	F	F		M	F	F	F	F	F	F	F	F	F	F	F	F		F	M	F	F	F	
(4-11) At Grade ^{[1][25]}	F ^[2]	F ^[2]	F ^[2]	F ^[2]	F	F ^[2]	F ^[2]	F ^[2]	F ^[2]	F	F	F		F	F ^[2]	F ^[2]	F	F	F	F	F ^[2]	F ^[2]	F ^[2]	F	F	F		F	F	F	F	F	
(4-12) Intersection ^[1]			F ^[2]	F ^[2]	F				F ^[2]	F	F	F		M	F	F	F	F	F	F			F ^[2]	F	F	F		F	M	F	F	F	
(4-13) Guardrail Upgrades				DE/F															F	F ^[23]										F	F ^[23]		
(4-14) Bridge Rail Upgrades																														F	F ^[22]	F	
(4-15) Risk: Roadside										F	EU/F	F	F																	F	F	F	F
(4-16) Risk: Sight Distance	F/M ^[21]	F/M ^[21]	F/M ^[21]	F/M ^[21]					F/M ^[21]	F ^[21]	F ^[21]	F		F	F/M ^[21]	F/M ^[21]	F	F	F	F					F/M ^[21]	F ^[21]	F ^[21]			F ^[21]	F		
(4-17) Risk: Roadway Width			F/M ^[21]	F/M ^[21]	F	F ^[21]	F/M ^[21]	F/M ^[21]	F/M ^[21]	F	F	F		F	F/M ^[21]	F/M ^[21]	F	F	F	F	F/M ^[21]	F/M ^[21]	F/M ^[21]	F	F			F ^[21]	F	F	F	F	
(4-18) Risk: Realignment	F ^[2]	F ^[2]	F ^[2]	F ^[2]	F	F ^[2]	F ^[2]	F ^[2]	F ^[2]	F	F	F		F	F/M ^[21]	F/M ^[21]	F	F	F	F	F ^[2]	F ^[2]	F ^[2]	F	F			F ^[21]	F	F	F	F	
(4-19) Collision Analysis Locations	Design Elements determined based on a Project Analysis ^[27]																																
Economic Development																																	
(4-20) Four-Lane Trunk System	F	F	F	F	F	F	F	F	F	F	F	F			F		F	F	F	F	F	F	F	F	F	F		F		F	F	F	

Design Matrix 4: Interchange Areas, NHS (Except Interstate), and Non-NHS
Exhibit 1100-7

↓ Project Type	Main Line													Bridges ^[11]				Intersections			Barriers				
	Horizontal Alignment	Vertical Alignment	Lane Width	Shoulder Width	Lane Transition	Median Width	Cross Slope Lane	Cross Slope Shoulder	Fill / Ditch Slopes	Access ^[3]	Clear Zone ^[18]	Sign., Del., Illum., & ITS	Basic Safety	Bike & Ped.	Lane Width	Shoulder Width	Vertical Clearance	Structural Capacity	Turn Radii	Angle	I/S Sight Distance	Term. & Trans. Section ^[12]	Standard Run	Bridge Rail ^[19]	
Preservation																									
Roadway																									
(5-1)	HMA/PCCP										[28]	[28]	B	M			F				[28]	F	[28]	F	
(5-2)	BST																								
(5-3)	BST Routes/Basic Safety										[28]	[28]	B								[28]	F	[28]	F	
(5-4)	Replace HMA w/PCCP at I/S			EU/M	EU/M		DE/M	EU/M			[28]	[28]	B	M			F				[28]	F	[28]	F	
Structures																									
(5-5)	Bridge Replacement	M	F	M	M	F		M	M	M		F	F		F	F ^[2]	F ^[2]	F	F	M	M	F	F	F	F
(5-6)	Bridge Repl. (Multilane)	F ^[2]	F ^[2]	F ^[2]	F ^[2]	F	F ^[2]	F ^[2]	F ^[2]	F ^[2]		F	F		F	F ^[2]	F ^[2]	F	F	F ^[2]	F ^[2]	F	F	F	F
(5-7)	Bridge Deck Rehab.										[28]	[28]	B	M							[28]	F ^[6]	F ^[22]	F	
Improvements^[16]																									
Mobility																									
(5-8)	Urban (Multilane)	F ^[2]	F ^[2]	F ^[2]	F ^[2]	F	F ^[2]	F ^[2]	F ^[2]	F ^[2]	F	F	F		F	F ^[2]	F ^[2]	F	F	EU/F	EU/F	F	F	F	F
(5-9)	Urban	M	M	M	M	F		M	M	M	F	F	F		F	M	M	F	F	EU/M	EU/M	F	F	F	F
(5-10)	Rural	M	M	M	M	F	M	M	M	M	F	F	F		F	M	M	F	F	EU/M	EU/M	F	F	F	F
(5-11)	HOV	M	M	M	M	F	M	M	M	M	F	F	F		F	M	M	F	F	EU/M	EU/M	F	F	F	F
(5-12)	Bike/Ped. Connectivity	[5]	[5]	[5]	[5]	[5]	[5]	[5]	[5]	[5]	[5]	[5]	[5]		F	[5]	[5]	[5]	[5]	[5]	[5]	[5]	[5]	[5]	[5]
Safety																									
(5-13)	Non-Interstate Freeway	F ^[2]	F ^[2]	F ^[2]	F ^[2]	F ^[2]	F ^[2]	F ^[2]	F ^[2]	F ^[2]	F	F	F		F	F ^[2]	F ^[2]	F		F ^[2]	F ^[2]	F	F	F	F
(5-14)	Intersection ^[1]			M ^[4]	M ^[4]	F				M ^[4]	F	F	F		M					M ^[4]	M ^[4]	F	F	F	F
(5-15)	Corridor ^{[1][24]}	M ^[4]	M ^[4]	M ^[4]	M ^[4]	F	M ^[4]	M ^[4]	M ^[4]	M ^[4]	F	F	F		M	M ^[4]	M ^[4]	F		M ^[4]	M ^[4]	F	F	F	F
(5-16)	Median Barrier				DE/F																		F ^[20]	F ^[20]	
(5-17)	Guardrail Upgrades				DE/F																		F	F ^[23]	
(5-18)	Bridge Rail Upgrades																						F	F ^[22]	F
(5-19)	Risk: Roadside									M ^[4]	EU/F	F	F										F	F	F
(5-20)	Risk: Sight Distance	F/M ^[21]	F/M ^[21]	F/M ^[21]	F/M ^[21]					F/M ^[21]	F ^[21]	F ^[21]	F		F	F ^[21]	F ^[21]	F ^[21]		F/M ^[21]	F/M ^[21]	F ^[21]	F	F	F
(5-21)	Risk: Roadway Width			F/M ^[21]	F/M ^[21]	F	F/M ^[21]	F/M ^[21]	F/M ^[21]	F/M ^[21]	F	F	F		F	F ^[21]	F ^[21]	F ^[21]		F/M ^[21]	F/M ^[21]	F ^[21]	F	F	F
(5-22)	Risk: Realignment	F/M	F/M	F/M	F/M	F	F/M	F ^[2]	F ^[2]	F/M	F	F	F		F	F ^[21]	F ^[21]	F ^[21]		F/M ^[21]	F/M ^[21]	F ^[21]	F	F	F
(5-23)	Collision Analysis Locations																								
Design Elements determined based on a Project Analysis ^[27]																									
Economic Development																									
(5-24)	Freight & Goods (Frost Free) ^[8]	EU/M	EU/M	EU/M	EU/M	EU/M	EU/M	M	M	EU/M		F	[28]	B	EU/F ^[26]	DE/M	DE/M	F		EU/M	EU/M	EU/F	F	[28]	F
(5-25)	Rest Areas (New)	F	F	F	F	F	F	F	F	F	F	F	F		F	F	F			F	F	F	F	F	F
(5-26)	Bridge Restrictions	M	F	M	M	F	M	M	M	M		F	F		EU/F ^[26]	M	M	F	F	M	M	F	F	F	F
(5-27)	Bike Routes (Shldr)			EU/M	[7]	EU/F			EU/M	EU/M		[28]	[28]	B	F	EU/M	EU/M					[28]	F	[28]	EU/F

Design Matrix 5: Main Line Non-NHS Routes
Exhibit 1100-8

Design Matrix Notes:

A blank cell indicates that the element is not applicable.

B Basic Design Level (see Chapter 1120).

F Full design level (see Chapter 1140).

M Modified design level (see Chapter 1130).

DE Design Exception to full design level.

EU Evaluate Upgrade to full design level.

- [1] Collision Reduction or Collision Prevention (At-Grade Removal, Signalization & Channelization). Specific deficiencies that created the project must be upgraded to design level as stated in the matrix.
- [2] Modified design level may apply based on a corridor or project analysis (see 1100.03(6)).
- [3] If designated as L/A acquired in the Access Control Tracking System, limited access requirements apply. If not, managed access applies (see 1100.03(6)).
- [4] Full design level may apply based on a corridor or project analysis (see 1100.03(6)).
- [5] For bike/pedestrian design, see Chapters 1510, 1515, and 1520.
- [6] Applies only to bridge end terminals and transition sections.
- [7] 4-ft minimum shoulders.
- [8] If all-weather structure can be achieved with spot digouts and overlay, modified design level applies to NHS highways and basic design level applies to non-NHS highways.
- [9] Continuous shoulder rumble strips required in rural areas (see Chapter 1600).
- [10] See Chapter 1020.
- [11] See Chapter 720.
- [12] Impact attenuators are considered as terminals.
- [13] See Chapters 1140 and 1230.
- [14] Includes crossroad bridge rail (see Chapter 1610).
- [15] EU for signing and illumination.
- [16] For design elements not in the matrix headings, apply full design level as found in the applicable chapters and see 1100.03(2).
- [17] DE for existing acceleration/deceleration lanes when length meets posted freeway speed and no significant crash history (see Chapter 1360).
- [18] On managed access highways within the limits of incorporated cities and towns, city and county design standards apply to areas outside the curb or outside the paved shoulder where no curb exists.
- [19] The funding sources for bridge rail are a function of the length of the bridge. Consult programming personnel.
- [20] Applies to median elements only.
- [21] Analyses required (see 1100.03(6) for details).
- [22] Upgrade barrier, if necessary, within 200 ft of the end of the bridge.
- [23] See description of Guardrail Upgrades Project Type, 1100.03(1), regarding length of need.
- [24] Apply full design level to projects that realign or reconstruct significant portions of the alignment.
- [25] For main line, use the Project Type row for Safety, Non-Interstate Freeway on Matrix 3 for NHS and on Matrix 5 for non-NHS.
- [26] Sidewalk ramps must be addressed for ADA compliance (see Chapter 1510).
- [27] Collision Analysis Locations (CALs) require a project analysis to document the needs at a location and determine the appropriate design elements to address.
- [28] See 1120.02, Basic Safety, for further information.

Design Matrix Notes

Exhibit 1100-9

- 1120.01 General
- 1120.02 Basic Safety
- 1120.03 Minor Safety and Minor Preservation Work
- 1120.04 Documentation

1120.01 General

Basic design level (B) preserves pavement structures, extends pavement service life, and restores the roadway for reasonably safe operations, which may include safety enhancements. Flexibility is provided so that other enhancements may be made while remaining within the scope of pavement preservation work.

The basic safety items of work listed below may be programmed under a separate project from the paving project as long as:

- There is some benefit to the delay.
- The safety features remain functional.
- The work is completed within two years after the completion of the paving project.

If some of the items are separated from the paving project, maintain a separate documentation file that addresses the separation of work during the two-year time period.

For bituminous surface treatment projects on non-NHS routes, the separation of basic safety is not limited to the two-year time period. The basic safety work can be accomplished separately using a corridor-by-corridor approach.

1120.02 Basic Safety

For basic design level, include the following items of work:

- Install and replace delineation in accordance with Chapter 1030.
- Install and replace rumble strips in accordance with the design matrices (see Chapters 1100 and 1600).
- Adjust existing features (such as monuments, catch basins, and access covers) that are affected by resurfacing.
- Adjust existing standard run of barriers, including guardrail height, in accordance with Chapter 1610.
- Replace signing as needed; this does not include replacement of sign bridges or cantilever supports. Refer to Chapter 1020 for design guidance.

- Relocate, protect, or provide breakaway features for sign supports, luminaires, WSDOT electrical service poles, and other intelligent transportation systems (ITS) equipment inside the Design Clear Zone. Consult with the region Traffic Engineer and review the WSDOT ITS plan to determine the specific ITS devices within the project limits and the requirements for each project (see Chapters 1020, 1040, 1050, and 1330).
- Restore sight distance at public road intersections and the inside of curves through low-cost measures (when available) such as removal or relocation of signs and other obstructions or cutting of vegetative matter (see Chapter 1310).
- Upgrade bridge rail in accordance with the matrices and Chapter 1610.
- Upgrade barrier terminals and bridge end protection, including transitions, in accordance with Chapter 1610.
- Restore the cross slope to 1.5% when the existing cross slope is flatter than 1.5% and the steeper slope is needed to provide adequate highway runoff in areas of intense rainfall (see Chapter 1230).
- Remove the rigid top rail and brace rails from Type 1 and Type 6 chain link fence and retrofit with a tension wire design (see Chapter 560).

1120.03 Minor Safety and Minor Preservation Work

Address the following items, where appropriate, within the limits of a pavement Preservation project:

- Spot safety enhancements, which are modifications to isolated roadway or roadside features that, in the engineer's judgment, reduce potential collision frequency or severity.
- When recommended by the region Traffic Engineer, additional or improved channelization to address intersection-related safety concerns, where sufficient pavement width and structural adequacy exist or can be obtained. With justification, which addresses the impacts to all roadway users, channelization improvements may be implemented, with lane and shoulder widths no less than the design criteria specified in the "Rechannelize Existing Pavement projects" section in Chapter 1110. Consider illumination of these improvements. Document decisions when full illumination is not provided, including an analysis of the frequency and severity of nighttime collisions.
- Roadside safety hardware (such as guardrail, signposts, and impact attenuators).
- Addressing Location 1 Utility Objects in accordance with the *Utilities Accommodation Policy*.
- Consider the addition of traffic signal control, illumination, and intelligent transportation systems (ITS) equipment. Consult with the region Traffic Engineer and review the WSDOT ITS plan to determine the specific requirements for each project (see Chapters 1040, 1050, and 1330).

To maintain the intended function of existing systems, consider the following:

- Right of way fencing (see Chapter 560)
- Drainage (see Chapter 800)
- Illumination (see Chapter 1040)
- Intelligent transportation systems (ITS) (see Chapter 1050)
- Traffic control signals (see Chapter 1330)
- Pedestrian use (see Chapters 1510 and 1515)
- Bicycle use (see Chapters 1515 and 1520)

Examples of the above include, but are not limited to:

- Installing short sections of fence needed to control access.
- Replacing grates that are not bicycle-safe (see Chapter 1520).
- Upgrading electrical system components that require excessive maintenance.
- Replacing or upgrading a traffic signal controller.
- Installing conduit and junction boxes for future traffic signal control, illumination, or ITS projects.
- Replacing or upgrading nonstructural traffic control signals, illumination, and ITS equipment that is near or beyond the life expectancy.
- Beveling culverts.

1120.04 Documentation

For the list of documents required to be preserved in the Design Documentation Package and the Project File, see the Design Documentation Checklist:

 www.wsdot.wa.gov/design/projectdev/

Radius of Centerline, R (ft)	Minimum Total Roadway Width ^[1] , W (ft)	Minimum Lane Width, L (ft)
Tangent	26	11
900	26	11
800	27	12
700	27	12
600	28	12
500	28	12
400	29	12
350	30	12
300	31	12
250	33	13
200	35	13
150	39	13

Notes:

Also see minimums from Exhibit 1130-11. If the minimum total roadway width is greater than the sum of the shoulders and lane widths, apply the extra width to the inside of the curve.

[1] Total width may include the shoulders.

Roadway width is based on:

- WB-63 design vehicle (the WB-63 was used as the design vehicle with 48-ft trailer adopted in the 1982 Surface Transportation Assistance Act).
- 2.5-ft clearance per lane.

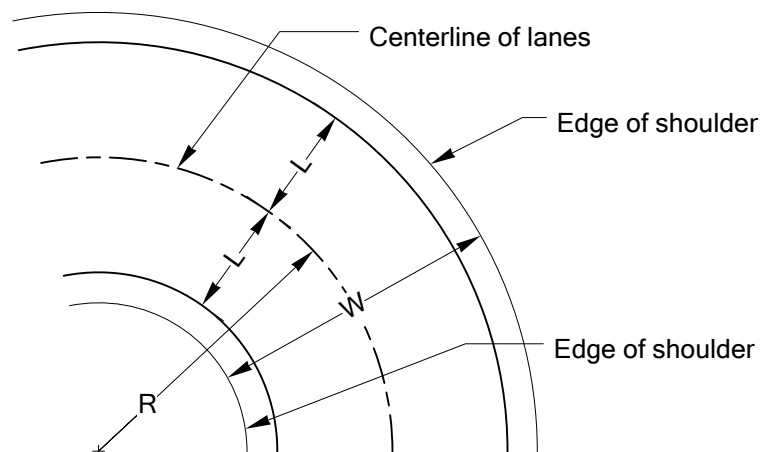

**Minimum Total Roadway Widths for Two-Lane Two-Way Highway Curves:
Modified Design Level**
Exhibit 1130-12a

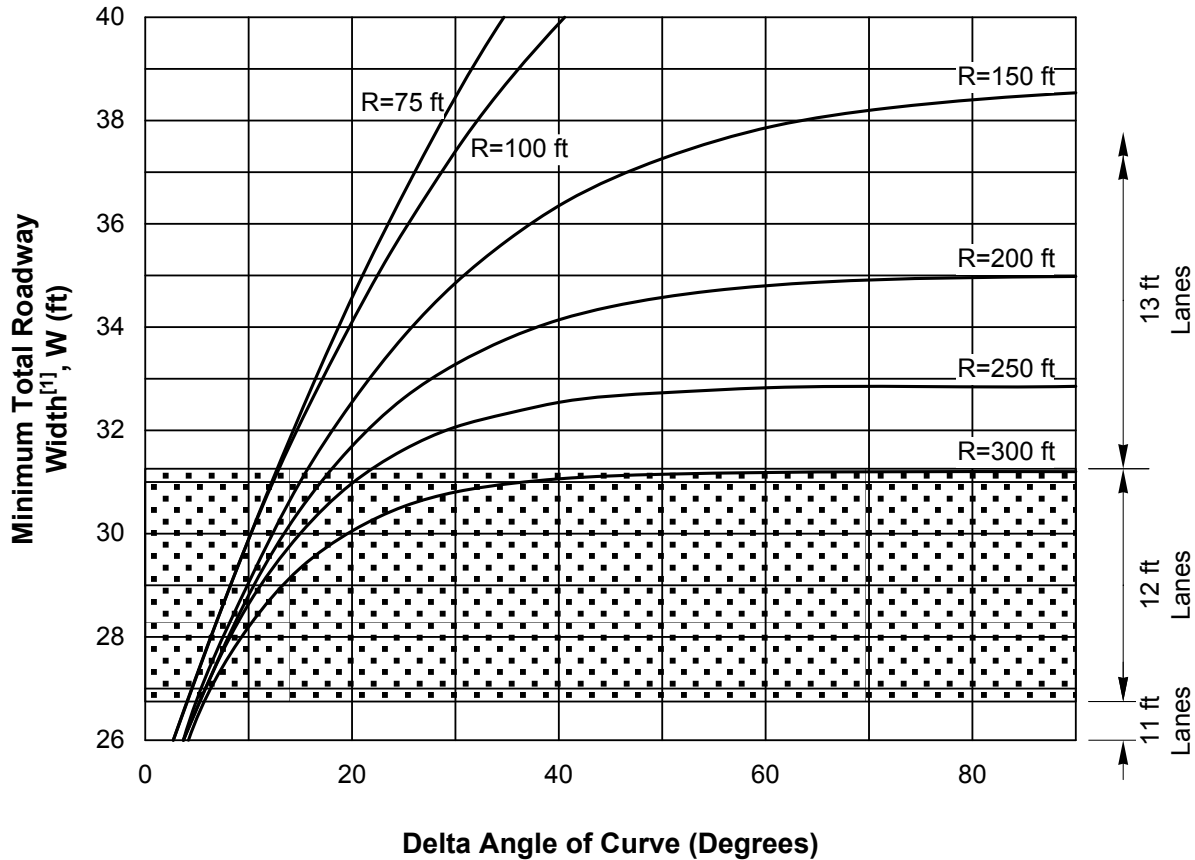

Notes:

May be used when the internal angle (delta) is less than 90°.

If result is less than the total roadway width from Exhibit 1130-11, use the greater.

[1] Total width may include the shoulders.

Roadway width is based on:

- WB-63 design vehicle (the WB-63 was used as the design vehicle with 48-ft trailer adopted in the 1982 Surface Transportation Assistance Act).
- 2.5-ft clearance per lane.

**Minimum Total Roadway Widths for Two-Lane Two-Way Highway Curves:
Modified Design Level, Based on the Delta Angle**
Exhibit 1130-12b

1140.01	General	1140.11	Curbs
1140.02	References	1140.12	Parking
1140.03	Definitions	1140.13	Pavement Type
1140.04	Functional Classification	1140.14	Structure Width
1140.05	Terrain Classification	1140.15	Right of Way Width
1140.06	Geometric Design Data	1140.16	Grades
1140.07	Design Speed	1140.17	Fencing
1140.08	Traffic Lanes	1140.18	<u>Traffic Signal Control, Illumination, and</u>
1140.09	Shoulders		<u>Intelligent Transportation Systems (ITS)</u>
1140.10	Medians	1140.19	Documentation

1140.01 General

Full design level is the highest level of design and is used on new and reconstructed highways. These projects are designed to provide optimum mobility, safety, and efficiency of traffic movement. The overall objective is to move the greatest number of vehicles, at the highest allowable speed, and at optimum safety. Major design controls are: functional classification; terrain classification; urban or rural surroundings; traffic volume; traffic character and composition; design speed; and access control.

1140.02 References

(1) Federal/State Laws and Codes

Revised Code of Washington (RCW) 46.61.575, Additional parking regulations

RCW 47.05.021, Functional classification of highways

RCW 47.24, City streets as part of state highways

Washington Administrative Code (WAC) 468-18-040, Design standards for rearranged county roads, frontage roads, access roads, intersections, ramps and crossings

(2) Design Guidance

Local Agency Guidelines (LAG), M 36-63, WSDOT

Plans Preparation Manual, M 22-31, WSDOT

Standard Plans for Road, Bridge, and Municipal Construction (Standard Plans), M 21-01, WSDOT

Standard Specifications for Road, Bridge, and Municipal Construction (Standard Specifications), M 41-10, WSDOT

(3) Supporting Information

A Policy on Design Standards: Interstate System, AASHTO, 2005

A Policy on Geometric Design of Highways and Streets (Green Book), AASHTO, 2004

1140.03 Definitions

collector system Routes that primarily serve the more important intercounty, intracounty, and intraurban travel corridors; collect traffic from the system of local access roads and convey it to the arterial system; and on which, regardless of traffic volume, the predominant travel distances are shorter than on arterial routes (RCW 47.05.021).

design speed The speed used to determine the various geometric design features of the roadway.

divided multilane A roadway with two or more through lanes in each direction and a median that physically or legally prohibits left turns, except at designated locations.

expressway A divided highway that has a minimum of two lanes in each direction for the exclusive use of traffic and that may or may not have grade separations at intersections.

freeway A divided highway that has a minimum of two lanes in each direction for the exclusive use of traffic and with full control of access.

frontage road A road that is a local road or street located parallel to a highway for service to abutting property and adjacent areas and for control of access.

functional classification The grouping of streets and highways according to the character of the service they are intended to provide.

high pavement type Portland cement concrete pavement or hot mix asphalt (HMA) pavement on a treated base.

highway A general term denoting a street, road, or public way for the purpose of vehicular travel, including the entire area within the right of way.

incorporated city or town A city or town operating under RCW 35 or 35A.

intermediate pavement type Hot mix asphalt pavement on an untreated base.

Interstate System A network of routes designated by the state and the Federal Highway Administration (FHWA) under terms of the federal-aid acts as being the most important to the development of a national system. The Interstate System is part of the principal arterial system.

lane A strip of roadway used for a single line of vehicles.

lane width The lateral design width for a single lane, striped as shown in the *Standard Plans* and the *Standard Specifications*. The width of an existing lane is measured from the edge of traveled way to the center of the lane line or between the centers of adjacent lane lines.

limited access highway Highways where the rights of direct access to or from abutting lands have been acquired from the abutting landowners.

low pavement type Bituminous surface treatment (BST).

managed access highway Highways where the rights of direct access to or from abutting lands have not been acquired from the abutting landowners.

median The portion of a highway separating the traveled ways for traffic in opposite directions.

1140.06 Geometric Design Data

(1) State Highway System

For projects on all highways in rural design areas and on limited access highways in urban design areas, the geometric design data is controlled by the functional class and traffic volume (see Exhibits 1140-5 through 1140-8). The urban managed access highway design class, based on traffic volume and design speed (see Exhibit 1140-9), may be used on managed access highways in urban design areas, regardless of the functional class.

(2) City Streets as State Highways

For a state highway within an incorporated city or town that is a portion of a city street, develop the design features in cooperation with the local agency. For facilities on the NHS, use *Design Manual* criteria as the minimum for the functional class of the route. For facilities not on the NHS, the *Local Agency Guidelines* may be used as the minimum design criteria; however, the use of *Design Manual* criteria is encouraged whenever feasible. On managed access highways within the limits of incorporated cities and towns, the cities or towns have full responsibility for design elements, including access, outside of curb, or outside the paved shoulder where no curb exists, using the *Local Agency Guidelines*.

(3) City Streets and County Roads

Plan and design facilities that cities or counties will be requested to accept as city streets or county roads according to the applicable design criteria shown in:

- WAC 468-18-040.
- *Local Agency Guidelines*.
- The design criteria of the local agency that will be requested to accept the facility.

1140.07 Design Speed

Vertical and horizontal alignment, sight distance, and superelevation vary with design speed. Such features as traveled way width, shoulder width, and lateral clearances are usually not affected. For the relationships between design speed, geometric plan elements, geometric profile elements, superelevation, and sight distance, see Chapters 1210, 1220, 1250, 1260, 1310, and 1360.

The choice of a design speed is primarily influenced by functional classification, posted speed, operating speed, terrain classification, traffic volumes, collision history, access control, and economic factors. A geometric design that adequately allows for future improvements is also a major criterion. Categorizing a highway by a terrain classification often results in arbitrary reductions of the design speed, when, in fact, the terrain would allow a higher design speed without materially affecting the cost of construction. Savings in vehicle operation and other costs alone might be sufficient to offset the increased cost of right of way and construction.

It is important to consider the geometric conditions of adjacent sections. Maintain a uniform design speed for a significant segment of highway.

For projects on all rural highways and limited access highways in urban design areas on new or reconstructed alignment (vertical or horizontal) or full width pavement reconstruction, the design speed for each design class is given in Exhibits 1140-5 through 1140-8.

For other projects, the desirable design speed is not less than that given in Exhibit 1140-1. Do not select a design speed less than the posted speed.

When terrain or existing development limits the ability to achieve the design speed for the design class, use a corridor analysis to determine the appropriate design speed.

On urban managed access highways, the design speed is less critical to the operation of the facility. Closely spaced intersections and other operational constraints usually limit vehicular speeds more than the design speed.

For managed access facilities in urban design areas, select a design speed based on Exhibit 1140-1. In cases where the Exhibit 1140-1 design speed does not fit the conditions, use a corridor analysis to select a design speed. Select a design speed not less than the posted speed that is logical with respect to topography, operating speed (or anticipated operating speed for new alignment), adjacent land use, design traffic volume, collision history, access control, and the functional classification. Consider both year of construction and design year. Maintain continuity throughout the corridor, with changes (such as a change in roadside development) at logical points.

Route Type	Posted Speed	Desirable Design Speed
Freeways	All	10 mph over the posted speed
Nonfreeways	45 mph or below	Not lower than the posted speed
	Over 45 mph	5 mph over the posted speed

Desirable Design Speed

Exhibit 1140-1

1140.08 Traffic Lanes

The minimum lane width is based on the highway design class, terrain type, and whether it is in a rural or urban design area. Lanes 12 feet wide provide desirable clearance between large vehicles where traffic volumes are high and sizable numbers of large vehicles are expected. The added cost for 12-foot lanes is offset, to some extent, by the reduction in shoulder maintenance costs due to the lessening of wheel load concentrations at the edge of the lane.

Highway capacity is also affected by the width of the lanes. With narrow lanes, drivers operate their vehicles closer (laterally) to each other than they normally desire. To compensate, drivers increase the headway, which results in reduced capacity.

Exhibits 1140-5 through 1140-8 give the minimum lane widths for the various design classes for use on all rural highways and limited access highways in urban design areas. Exhibit 1140-9 gives the minimum lane widths for urban managed access highways.

The roadway on a curve may need to be widened to make the operating conditions comparable to those on tangents. For guidance on turning roadway width, see Chapter 1240.

1140.09 Shoulders

Shoulder width is controlled by the functional classification of the roadway, the traffic volume, and the shoulder function.

The more important shoulder functions and the associated minimum widths are given in Exhibit 1140-2. In addition to the functions in Exhibit 1140-2, shoulders also:

- Provide space to escape potential collisions or reduce their severity.
- Provide a sense of openness, contributing to driver ease and freedom from strain.
- Reduce seepage adjacent to the traveled way by discharging stormwater farther away.

Shoulder Function	Minimum Shoulder Width
Stopping out of the traffic lanes	8 ft ^[1]
Minimum lateral clearance	2 ft ^[2]
Pedestrian or bicycle use	4 ft ^[3]
Large-vehicle off-tracking on curves	See Chapters 1130, 1240 & 1310
Maintenance operations	Varies ^[4]
Law enforcement	8 ft ^[5]
Bus stops	See Chapter 1430
Slow-vehicle turnouts and shoulder driving	See Chapter 1270
Ferry holding	8 ft ^[6]
For use as a lane during reconstruction of the through lanes	8 ft ^[6]
Structural support of pavement	2 ft
Improve sight distance in cut sections	See Chapter 1260
Improve capacity	See Chapter 320
Notes: [1] 10-ft minimum for trucks; 12-ft preferred. [2] See Chapters 1600 and 1610. [3] Minimum usable shoulder width for bicycles. For guidance, see Chapter 1520 for accommodating bicycles and Chapter 1510 for accommodating pedestrians. [4] 10-ft usable width to park a maintenance truck out of the through lane; 12-ft clearance (14-ft preferred) for equipment with outriggers to work out of traffic. [5] For additional information, see Chapters 1410 and 1720. [6] Minimum usable shoulder width (10-ft preferred).	

Minimum Shoulder Width
Exhibit 1140-2

Contact the region Maintenance Office to determine the shoulder width for maintenance operations. When shoulder widths wider than called for in Exhibits 1140-5 through 1140-9 are requested, compare the added cost of the wider shoulders to the added benefits to maintenance operations as well as other benefits that may be derived. When the region Maintenance Office requests a shoulder width different than the design class, provide justification for the width selected.

Minimum shoulder widths for use on all rural highways and limited access highways in urban design areas are based on functional classification and traffic volume (see Exhibits 1140-5 through 1140-8). Exhibit 1140-9 gives the minimum shoulder widths for urban managed access highways without curb. (See Chapter 1310 for guidance on shoulder widths at intersections.)

When curb with a height less than 24 inches is present on urban managed access highways, provide the minimum shoulder widths shown in Exhibit 1140-3. For information on curbs, see 1140.11.

When traffic barrier with a height of 2 feet or greater is used adjacent to the roadway, the minimum shoulder width from the edge of traveled way to the face of the traffic barrier is 4 feet. Additional width for traffic barrier shy distance (see Chapter 1610) is normally not provided on urban managed access highways.

Where there are no sidewalks, the minimum shoulder width is 4 feet. Shoulder widths less than 4 feet will require that wheelchairs using the roadway encroach on the through lane. For additional information and guidance regarding pedestrians and accessible routes, see Chapter 1510.

Lane Width	Posted Speed			
	>45 mph	≤45 mph	>45 mph	≤45 mph
	On Left		On Right ^[3]	
12 ft or wider	4 ft	^[1] ^[2]	4 ft	2 ft
11 ft	4 ft	^[1] ^[2]	4 ft	3 ft ^[4]

Notes:

[1] When mountable curb is used on routes with a posted speed of 35 mph or lower, shoulder width is desirable; however, with justification, curb may be placed at the edge of traveled way.

[2] 1 ft for curbs with a height of 8 inches or less. 2 ft for curbs or barriers with a height between 8 and 24 inches.

[3] When the route has been identified as a local, state, or regional significant bike route, the minimum shoulder width is 4 ft. Where signed bike lanes are present, see Chapter 1520 for guidance.

[4] When bikes are not a consideration, width may be reduced to 2 ft with justification.

[5] Measured from the edge of traveled way to the face of curb.

Shoulder Width for Curbed Sections^[5] in Urban Areas
Exhibit 1140-3

The usable shoulder width is less than the constructed shoulder width when vertical features (such as traffic barrier or walls) are at the edge of the shoulder. This is because drivers tend to shy away from the vertical feature. For traffic barrier shy distance widening, see Chapter 1610.

Shoulders on the left between 4 feet and 8 feet wide are less desirable. A shoulder in this width range might appear to a driver to be wide enough to stop out of the through traffic, when it is not. To reduce the occurrence of this situation, when the shoulder width and any added clearance result in a width in this range, consider increasing the width to 8 feet.

Provide a minimum clearance to roadside objects to prevent shoulder narrowing. At existing bridge piers and abutments, a shoulder less than full width to a minimum of 2 feet is a design exception. For Design Clear Zone and safety treatment guidance, see Chapter 1600.

For routes identified as local, state, or regional significant bicycle routes, provide a minimum 4-foot shoulder. Maintain system continuity for the bicycle route, regardless of jurisdiction and functional class. For additional information on bicycle facilities, see Chapter 1520.

Shoulder widths greater than 10 feet may encourage use as a travel lane. Therefore, use shoulders wider than this only to meet one of the listed functions (see Exhibit 1140-2).

When walls are placed adjacent to shoulders, see Chapter 730 for barrier guidance.

1140.10 Medians

Medians are either restrictive or nonrestrictive. Restrictive medians limit left turns, physically or legally, to defined locations. Nonrestrictive medians allow left turns at any point along the route. Consider restrictive medians on multilane limited access highways and multilane managed access highways when the design hourly volume (DHV) is over 2000.

The primary functions of a median are to:

- Separate opposing traffic.
- Provide for recovery of out-of-control vehicles.
- Reduce head-on collisions.
- Provide an area for emergency parking.
- Allow space for left-turn lanes.
- Minimize headlight glare.
- Allow for future widening.
- Control access.

Medians may be depressed, raised, or flush with the through lanes. For maximum efficiency, make medians highly visible both night and day.

The width of a median is measured from edge of traveled way to edge of traveled way and includes the shoulders. The desirable median width is given in Exhibit 1140-4. The minimum width is the width required for shoulders and barrier (including shy distance) or ditch.

When selecting a median width, consider future needs such as wider left shoulders when widening from four to six lanes. A median width of 22 feet is desirable on a four-lane highway when additional lanes are anticipated. The minimum width to provide additional lanes in the median, without widening to the outside, is 46 feet. On freeways or expressways requiring less than eight lanes within the 20-year design period, provide sufficient median or lateral clearance and right of way to permit the addition of a lane in each direction.

A two-way left-turn lane (TWLTL) may be used as a nonrestrictive median for an undivided managed access highway (see Exhibit 1140-9). The desirable width of a TWLTL is 13 feet, with a minimum width of 11 feet. For more information on traffic volume limits for TWLTLs on managed access highways, see Chapter 540. For additional information on TWLTL design, see Chapter 1310.

A common form of restrictive median on urban managed access highways is the raised median. The width of a raised median can be minimized by using a dual-faced cement concrete traffic curb, a precast traffic curb, or an extruded curb. For more information on traffic volume limits for restrictive medians on managed access highways, see Chapter 540.

Median Usage	Desirable Width (ft) ^[1]
Separate opposing traffic on freeways and expressways	
Rural	60 ^[2]
Urban – 4-lane	18
Urban – 6 or more lanes	22
Allow for future widening	46 ^[4]
Left-turn lanes ^[3]	13 ^[2]
Control access on divided multilane urban managed access highways	
Design speed 45 mph or lower with raised medians	3 ^{[5][6]}
Design speed greater than 45 mph or barrier separated	10 ^[6]
Notes:	
[1] The minimum width is the width required for shoulders and barrier (including shy distance) or ditch. For barrier requirements, see Chapter 1610.	
[2] Provide additional width at rural expressway intersections for storage of vehicles crossing expressway or entering expressway with a left turn.	
[3] For additional information, see Chapter 1310.	
[4] Narrower width will require widening to the outside for future lanes.	
[5] Using a Dual-Faced Cement Concrete Traffic Curb 1 ft face of curb to face of curb.	
[6] 12 ft desirable to allow for left-turn lanes.	

Median Width
Exhibit 1140-4

1140.12 Parking

In urban design areas and rural communities, land use might make parking along the highway desirable. In general, on-street parking decreases capacity, increases collisions, and impedes traffic flow; therefore, it is desirable to prohibit parking.

Although design data for parking lanes are included in Exhibits 1140-6 through 1140-9, consider them only in cooperation with the municipality involved. The lane widths given are the minimum for parking; provide wider widths when feasible.

Angle parking is not permitted on any state route without WSDOT approval (RCW 46.61.575). This approval is delegated to the State Traffic Engineer. Angle parking approval is to be requested through the Headquarters (HQ) Design Office. Provide an engineering study, approved by the region Traffic Engineer, with the request documenting that the parking will not unduly reduce safety and that the roadway is of sufficient width that parking will not interfere with the normal movement of traffic.

1140.13 Pavement Type

The pavement types given in Exhibits 1140-5 through 1140-8 are those recommended for each design class. (See Chapter 620 for information on pavement type selection.) When a roadway is to be widened and the existing pavement will remain, the new pavement type may be the same as the existing without a pavement type determination.

1140.14 Structure Width

Provide a clear width between curbs or barrier on a structure not less than the approach roadway width (lanes plus shoulders). The structure widths given in Exhibits 1140-5 through 1140-9 are the minimum structure widths for each design class.

Additional width for shy to barriers is not normally added to the roadway width on structures. When a structure is in a run of roadside barrier with the added width, consider adding the width on shorter structures to keep a constant roadway width.

1140.15 Right of Way Width

Provide right of way width sufficient to accommodate roadway elements and appurtenances for the current design and known future improvements. To allow for construction and maintenance activities, provide 10 feet desirable, 5 feet minimum, wider than the slope stake for fill and slope treatment for cut. For slope treatment information, see Chapter 1230 and the *Standard Plans*.

For new alignment requiring purchase of new right of way, refer to Exhibits 1140-5 through 1140-8. For additional information on right of way acquisition, see Chapter 510.

1140.16 Grades

Grades can have a pronounced effect on the operating characteristics of the vehicles negotiating them. Generally, passenger cars can readily negotiate grades as steep as 5% without appreciable loss of speed from that maintained on level highways. Trucks, however, travel at the average speed of passenger cars on the level roadway, but they display up to a 5% increase in speed on downgrades and a 7% or greater decrease in speed on upgrades (depending on length and steepness of grade as well as weight-to-horsepower ratio).

The maximum grades for the various functional classes and terrain conditions are shown in Exhibits 1140-5 through 1140-8. For the effects of these grades on the design of a roadway, see Chapters 1220, 1260, 1270, 1310, and 1360.

1140.17 Fencing

Remove rigid top rails and brace rails from existing fencing and retrofit with a tension wire design. For information on fencing, see Chapter 560.

1140.18 Traffic Signal Control, Illumination, and Intelligent Transportation Systems (ITS)

For information on intelligent transportation systems (ITS), see Chapter 1050. ITS installation is determined by the mobility, traveler information, safety, maintenance, and other operational needs of the highway system. Consult with the region Traffic Engineer and review the WSDOT ITS plan to determine the full design level requirements for ITS: www.wsdot.wa.gov/MaintOps/traffic/pdf/ITSPlan32409.pdf

1140.19 Documentation

For the list of documents required to be preserved in the Design Documentation Package and the Project File, see the Design Documentation Checklist:

www.wsdot.wa.gov/design/projectdev/

(2) Minimum Length of Vertical Curves

The minimum length of a vertical curve is controlled by design speed, stopping sight distance, and the change in grade. Make the length of a vertical curve, in feet, not less than three times the design speed, in miles per hour. (See Chapter 1260 to design vertical curves to meet stopping sight distance criteria.) For aesthetics, the desirable length of a vertical curve is two to three times the length to provide stopping sight distance.

Sag vertical curves may have a length less than required for stopping sight distance when all three of the following are provided:

- An evaluate upgrade to justify the length reduction.
- Continuous illumination.
- Design for the comfort of the vehicle occupants. For comfort, use:

$$L = \frac{AV^2}{46.5}$$

Where:

- L = Curve length (ft)
 A = Change in grade (%)
 V = Design speed (mph)

The sag vertical curve lengths designed for comfort are about 50% of those for sight distance.

(3) Maximum Grades

Analyze grades for their effect on traffic operation because they may result in undesirable truck speeds. Maximum grades are controlled by functional class of the highway, terrain type, and design speed (see Chapters 1140 and 1360).

(4) Minimum Grades

Minimum grades are used to meet drainage requirements. Avoid selecting a “roller coaster” or “hidden dip” profile merely to accommodate drainage.

Minimum ditch gradients of 0.3% on paved materials and 0.5% on earth can be obtained independently of roadway grade. Medians, long sag vertical curves, and relatively flat terrain are examples of areas where independent ditch design may be justified. A closed drainage system may be needed as part of an independent ditch design.

(5) Length of Grade

The desirable maximum length of grade is the maximum length on an upgrade at which a loaded truck will operate without a 10 mph reduction. Exhibit 1220-1 gives the desirable maximum length for a given percent of grade. When grades longer than the desirable maximum are unavoidable, consider an auxiliary climbing lane (see Chapter 1270). For grades that are not at a constant percent, use the average.

When long, steep downgrades are unavoidable, consider an emergency escape ramp (see Chapter 1270).

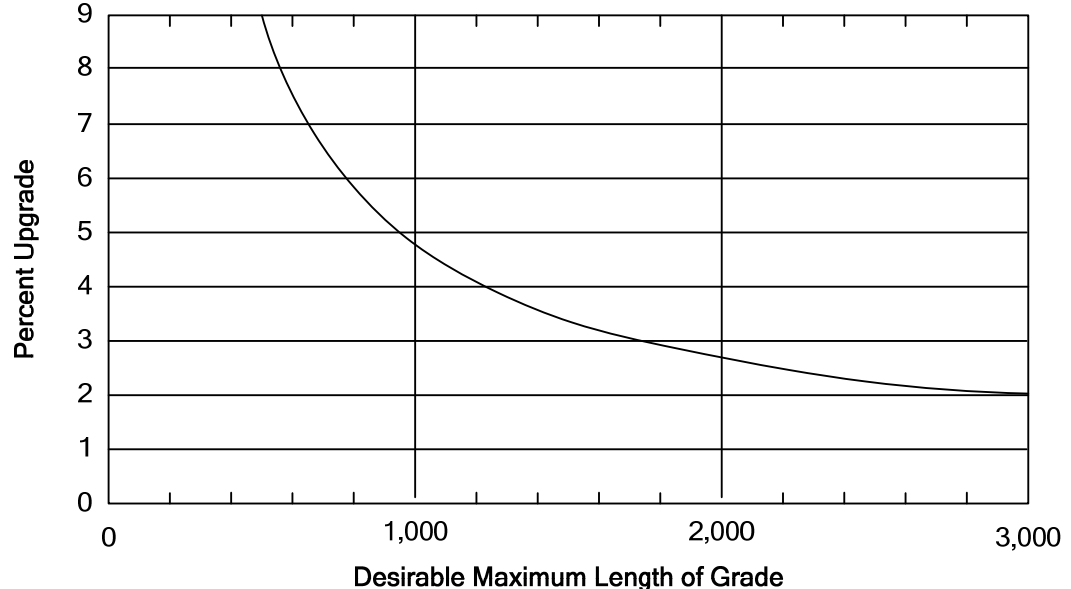

For grades longer than indicated, consider an auxiliary climbing lane (see Chapter 1270).

Grade Length
Exhibit 1220-1

(6) Alignment on Structures

Where practicable, avoid high skew, vertical curvature, horizontal curvature, and superelevation on structures, but do not sacrifice safe roadway alignment to achieve this.

1220.04 Coordination of Vertical and Horizontal Alignments

Do not design horizontal and vertical alignments independently. Coordinate them to obtain uniform speed, pleasing appearance, and efficient traffic operation. Coordination can be achieved by plotting the location of the horizontal curves on the working profile to help visualize the highway in three dimensions. Perspective plots will also give a view of the proposed alignment. Exhibits 1220-2a and 2b show sketches of desirable and undesirable coordination of horizontal and vertical alignment.

Guides for the coordination of the vertical and horizontal alignment are as follows:

- Balance curvature and grades. Using steep grades to achieve long tangents and flat curves or excessive curvature to achieve flat grades are both poor designs.
- Vertical curvature superimposed on horizontal curvature generally results in a more pleasing facility. Successive changes in profile not in combination with horizontal curvature may result in a series of dips not visible to the driver.
- Do not begin or end a horizontal curve at or near the top of a crest vertical curve. A driver may not recognize the beginning or ending of the horizontal curve, especially at night. An alignment where the horizontal curve leads the vertical curve and is longer than the vertical curve in both directions is desirable.
- To maintain drainage, design vertical and horizontal curves so that the flat profile of a vertical curve is not be located near the flat cross slope of the superelevation transition.
- Do not introduce a sharp horizontal curve at or near the low point of a pronounced sag vertical curve. The road ahead is foreshortened and any horizontal curve that is not flat assumes an undesirably distorted appearance. Further, vehicular speeds, particularly of trucks, often are high at the bottom of grades and erratic operation may result, especially at night.
- On two-lane roads, the need for passing sections (at frequent intervals and for an appreciable percentage of the length of the roadway) often supersedes the general desirability for the combination of horizontal and vertical alignment. Work toward long tangent sections to secure sufficient passing sight distance.
- On divided highways, consider variation in the width of medians and the use of independent alignments to derive the design and operational advantages of one-way roadways.
- Make the horizontal curvature and profile as flat as practicable at intersections where sight distance along both roads is important and vehicles may have to slow or stop.
- In residential areas, design the alignment to minimize nuisance factors to the neighborhood. Generally, a depressed facility makes a highway less visible and less noisy to adjacent residents. Minor horizontal adjustments can sometimes be made to increase the buffer zone between the highway and clusters of homes.
- Design the alignment to enhance attractive scenic views of the natural and constructed environment, such as rivers, rock formations, parks, and outstanding buildings.

When superelevation transitions fall within the limits of a vertical curve, plot profiles of the edges of pavement and check for smooth transitions.

1220.05 Airport Clearance

Contact the airport authorities early for proposed highway construction or alteration in the vicinity of a public or military airport, so that advance planning and design work can proceed within the required Federal Aviation Administration (FAA) regulations (see Chapter 230).

1220.06 Railroad Crossings

When a highway crosses a railroad at grade, design the highway grade to prevent low-hung vehicles from damaging the rails or getting hung up on the tracks. Exhibit 1220-3 gives guidance on designing highway grades at railroad crossings. For more information on railroad-highway crossings, see Chapter 1350.

1220.07 Procedures

When the project modifies the vertical alignment, develop vertical alignment plans for inclusion in the Plans, Specifications, and Estimates (PS&E) to a scale suitable for showing vertical alignment for all proposed roadways, including ground line, grades, vertical curves, and superelevation. (See the *Plans Preparation Manual* for guidance.)

When justifying any modification to the vertical alignment, include the reasons for the change, alternatives addressed (if any) and why the selected alternative was chosen. When the profile is a result of new horizontal alignment, develop vertical and horizontal alignments together, and include the profile with the horizontal alignment justification.

1220.08 Documentation

For the list of documents required to be preserved in the Design Documentation Package and the Project File, see the Design Documentation Checklist:

🔗 www.wsdot.wa.gov/design/projectdev/

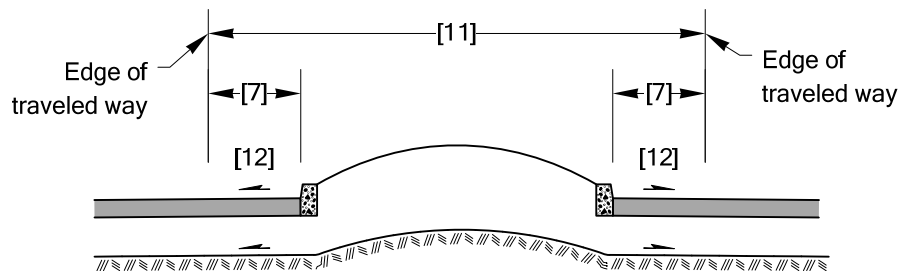

Design F: Raised Median^[13]

Notes:

- [1] For minimum median width, see Chapters 1130 and 1140.
- [2] Consider vertical clearances, drainage, and aesthetics when locating the pivot point.
- [3] Generally, slope pavement away from the median. Where appropriate, a crowned roadway section may be used in conjunction with the depressed median. (See Exhibit 1230-1 for additional crown information.)
- [4] Design B may be used uniformly on both tangents and horizontal curves. Use Alternate Design 1 or Alternate Design 2 when the "rollover" between the shoulder and the inside lane on the high side of a superelevated curve exceeds 8%. Provide suitable transitions at each end of the curve for the various conditions encountered in applying the alternate to the basic median design.
- [5] Method of drainage pickup to be determined by the designer.
- [6] Median shoulders normally slope in the same direction and rate as the adjacent through lane. (See 1230.04(3) for examples and additional information for locations where it may be desirable to have a shoulder cross slope different than the adjacent lane.)
- [7] For minimum shoulder width, see Chapters 1130 and 1140.
- [8] Future lane. (See Chapter 1140 for minimum width.)
- [9] Widen and round foreslopes steeper than 4H:1V, as shown in Exhibit 1230-5b.
- [10] Designs C, D, and E are rural median designs. (See Chapter 1140 for minimum rural median widths.) Rural median designs may be used in urban areas when minimum rural median widths can be achieved.
- [11] For minimum median width, see Chapter 1140. Raised medians may be paved or landscaped. For clear zone and barrier guidelines when fixed objects or trees are in the median, see Chapter 1600.
- [12] Lane and shoulders normally slope away from raised medians. When they slope toward the median, provide for drainage.
- [13] The desirable maximum design speed for a raised median is 45 mph. When the design speed is above 45 mph, Design A or Design B is desirable.

Divided Highway Median Sections
Exhibit 1230-6c

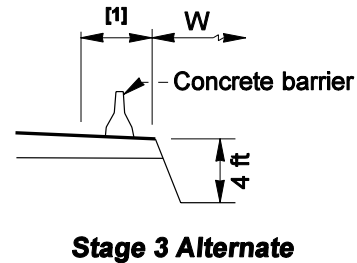
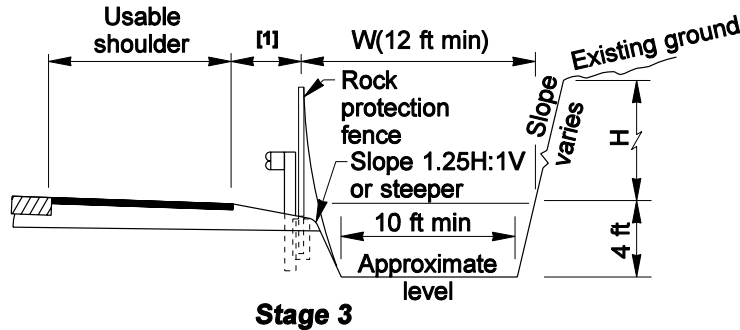
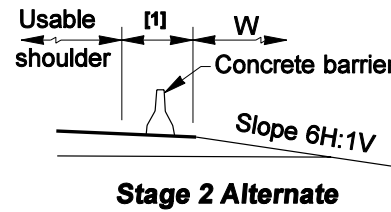
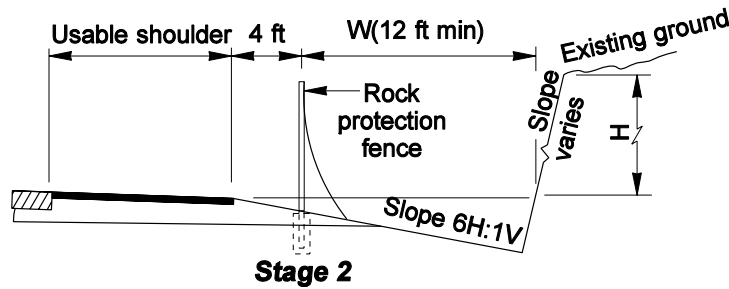
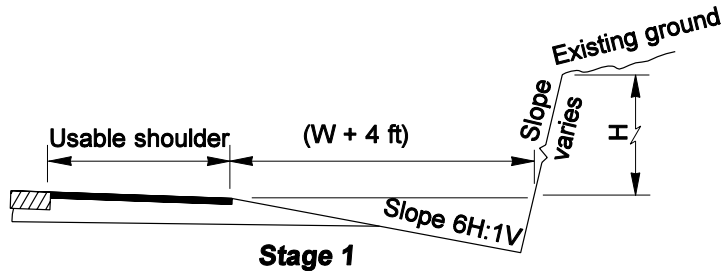

Rock Slope	H (ft)	W (ft)
Near Vertical	20 – 30	12
	30 – 60	15
	> 60	20
0.25H:1V through 0.50H:1V	20 – 30	12
	30 – 60	15
	60 – 100	20
	>100	25

Notes:

[1] For widening for guardrail and concrete barrier, see Chapter 1610.

General:

- Treat cut heights less than 20 feet as a normal roadway unless otherwise determined by the Region Materials Engineer.
- Stage 2 and Stage 3 Alternates may be used when site conditions dictate.
- Fence may be used in conjunction with the Stage 3 Alternate. (See Chapter 1600 for clear zone guidelines.)

Roadway Sections in Rock Cuts: Design A
Exhibit 1230-7a

(3) One-Lane Roadways

Exhibit 1240-3a shows the traveled way width (W) for one-lane turning roadways, including one-lane ramps. For values of R between those given, interpolate W and round up to the next foot.

Minimum width (W), based on the delta angle of the curve for one-lane roadways, may be used. Exhibit 1240-3b gives W using the radius to the outer edge of the traveled way. Exhibit 1240-3c gives W using the radius on the inner edge of the traveled way. Document the reasons for using the minimum width. Round W to the nearest foot.

Build shoulder pavements at full depth for one-lane roadways. To keep widths to a minimum, traveled way widths were calculated using the WB-40 design vehicle, which may force larger vehicles to encroach on the shoulders. This also helps to maintain the integrity of the roadway structure during partial roadway closures.

(4) Other Roadways

For roadways where the traveled way is more than two lanes in any direction, for each lane in addition to two, add the lane width for the highway functional class from Chapter 1140 to the width from 1240.04(2).

For three-lane ramps with HOV lanes, see Chapter 1410.

(5) Total Roadway Width

Full design shoulder widths for the highway functional class or ramp are added to the traveled way width to determine the total roadway width.

Small amounts of widening add to the cost with little added benefit. When the traveled way width for turning roadways results in widening less than 0.5 foot per lane or a total widening of less than 2 feet on existing roadways that are to remain in place, it may be disregarded.

When widening the traveled way:

- Widening may be constructed on the inside of the traveled way or divided equally between the inside and outside. Do not construct widening only on the outside of a curve.
- Place final marked lane lines, and any longitudinal joints, at equal spacing between the edges of the widened traveled way.
- Provide widening throughout the curve length.
- For widening on the inside, make transitions on a tangent where possible.
- For widening on the outside, develop the widening by extending the tangent. This avoids the appearance of a reverse curve that a taper would create.
- For widening of 6 feet or less, use a 1:25 taper. For widths greater than 6 feet, use a 1:15 taper.

1240.05 Documentation

For the list of documents required to be preserved in the Design Documentation Package and the Project File, see the Design Documentation Checklist:

☞ www.wsdot.wa.gov/design/projectdev/

Radius on Centerline of Traveled Way, R (ft)	Design Traveled Way Width, W (ft) ^[1]
3,000 to tangent	24
2,999	25
2,000	26
1,000	27
800	28
600	29
500	30
400	31
350	32
300	33
250	35
200	37
150	41

Note:

[1] Width (W) is based on:

- WB-67 design vehicle.
- 3-ft clearance per lane (12-ft lanes).

When 11-ft lanes are called for, width may be reduced by 2 ft.

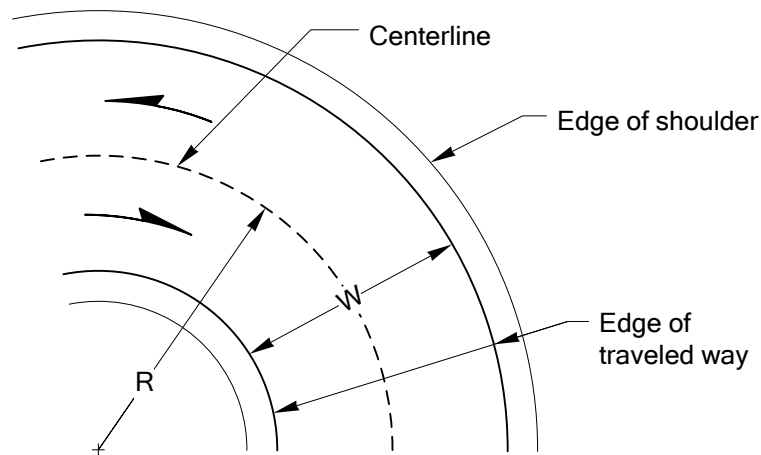

Traveled Way Width for Two-Lane Two-Way Turning Roadways
Exhibit 1240-1a

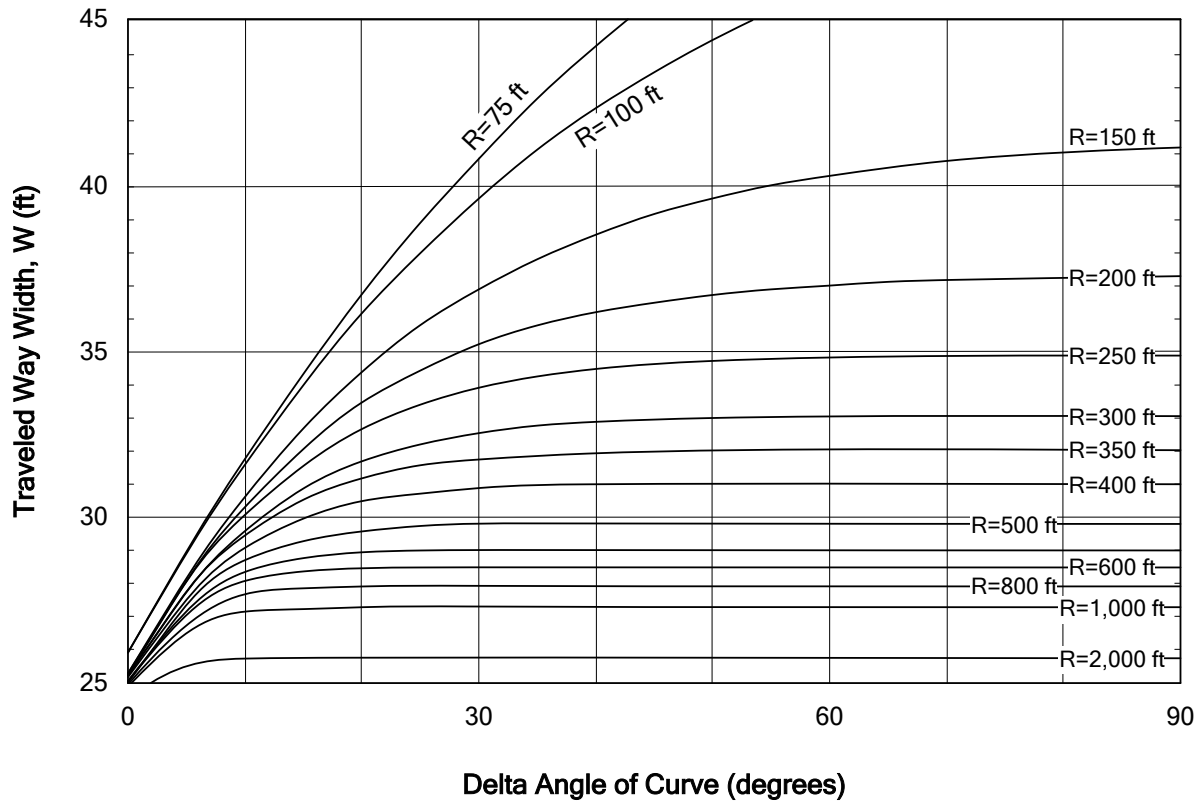

Note:

Width (W) is based on:

- WB-67 design vehicle.
- 3-ft clearance per lane (12-ft lanes).

When 11-ft lanes are called for, width may be reduced by 2 ft.

**Traveled Way Width for Two-Lane Two-Way Turning Roadways:
Based on the Delta Angle**
Exhibit 1240-1b

Radius on Centerline of Traveled Way, R (ft)	Design Traveled Way Width, W (ft) ^[1]
3,000 to tangent	24
1,000 to 2,999	25
999	26
600	26
500	27
400	27
300	28
250	29
200	29
150	31
100	34

Note:

[1] Width (W) is based on:

- WB-40 design vehicle.
- 3-ft clearance per lane (12-ft lanes).

When 11-ft lanes are called for, width may be reduced by 2 ft.

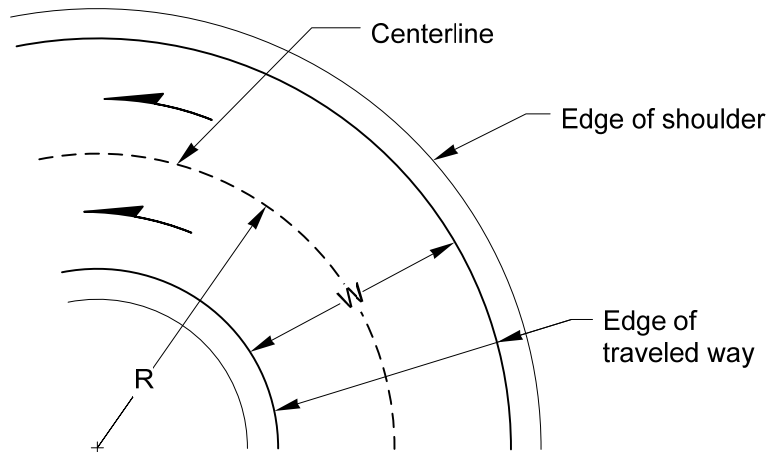

Traveled Way Width for Two-Lane One-Way Turning Roadways
Exhibit 1240-2a

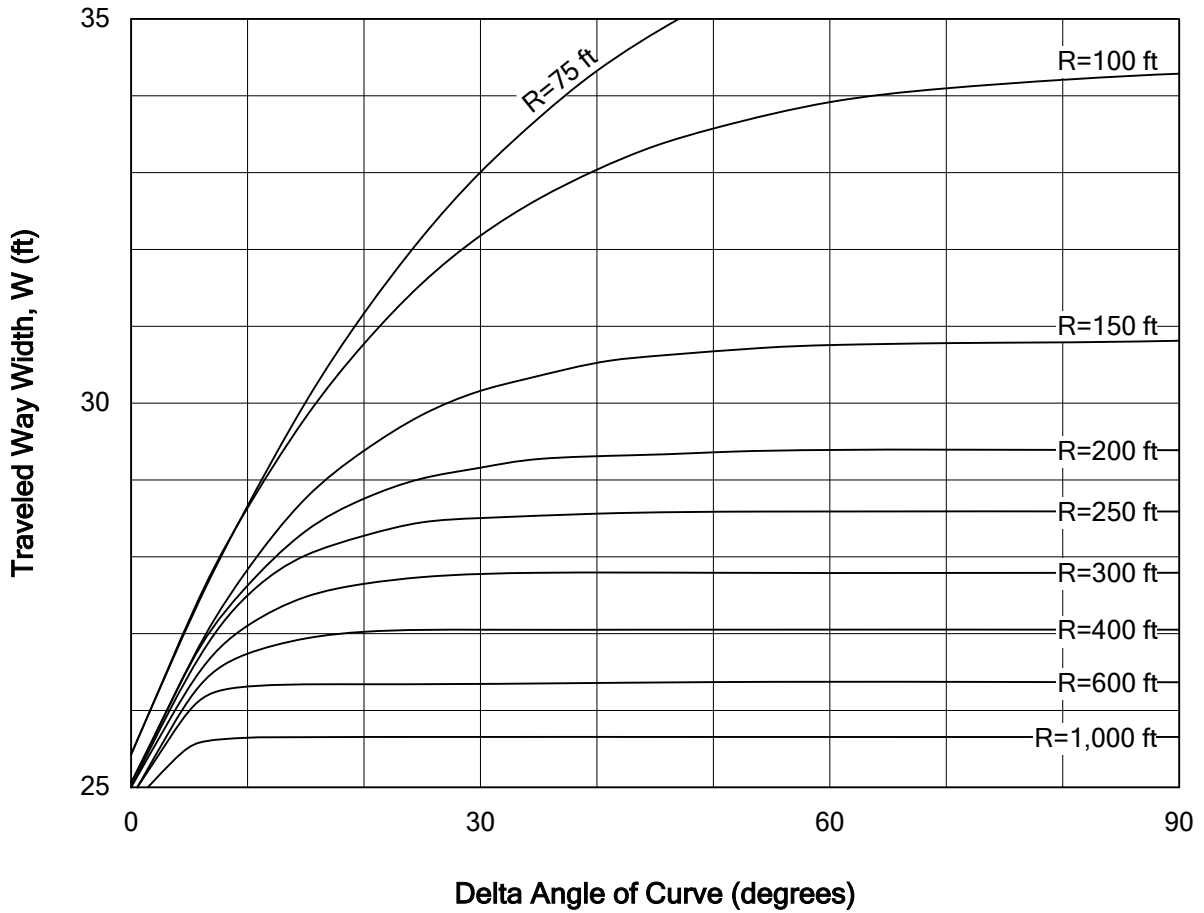

Note:

Width (W) is based on:

- WB-40 design vehicle.
- 3-ft clearance per lane (12-ft lanes).

When 11-ft lanes are called for, width may be reduced by 2 ft.

**Traveled Way Width for Two-Lane One-Way Turning Roadways:
Based on the Delta Angle
Exhibit 1240-2b**

Radius, R (ft)	Design Traveled Way Width, W (ft)	
	Radius on Outside Edge of Traveled Way	Radius on Inside Edge of Traveled Way
7,500 to tangent	13 ^[1]	13 ^[1]
1,600	14	14
300	15	15
250	16	16
200	17	17
150	17	17
100	19	18
75	21	19
50	26	22

Note:

[1] On tangents, the minimum lane width may be reduced to 12 ft.

Width (W) is based on:

- WB-40 design vehicle.
- 4-ft clearance.

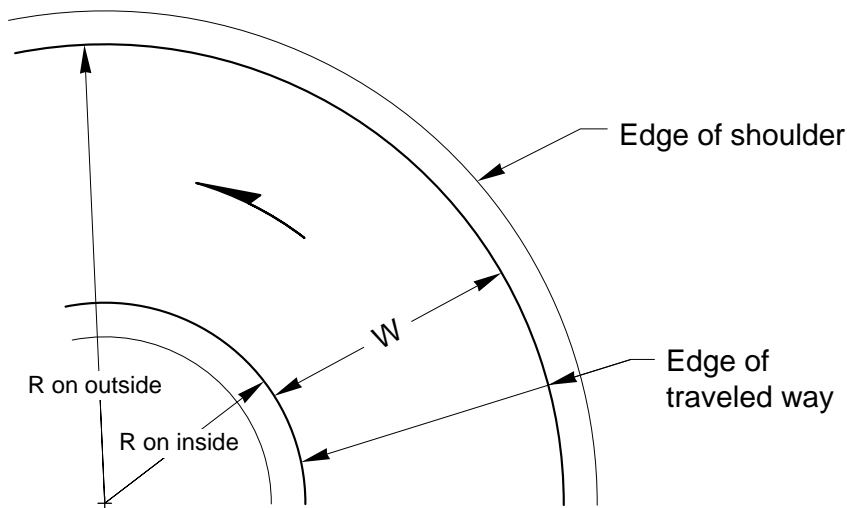

Traveled Way Width for One-Lane Turning Roadways

Exhibit 1240-3a

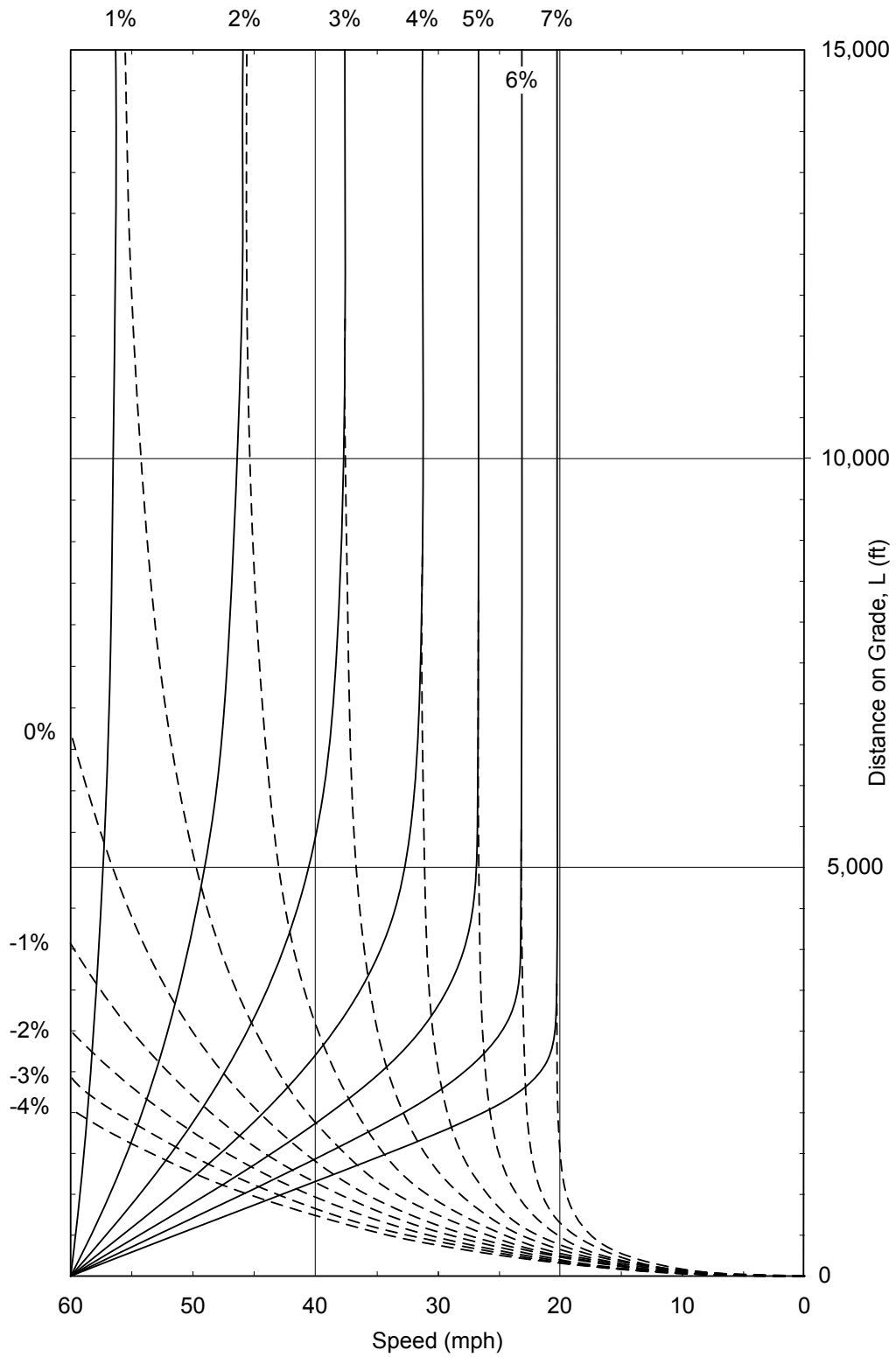

Speed Reduction Warrant: Performance for Trucks
Exhibit 1270-2a

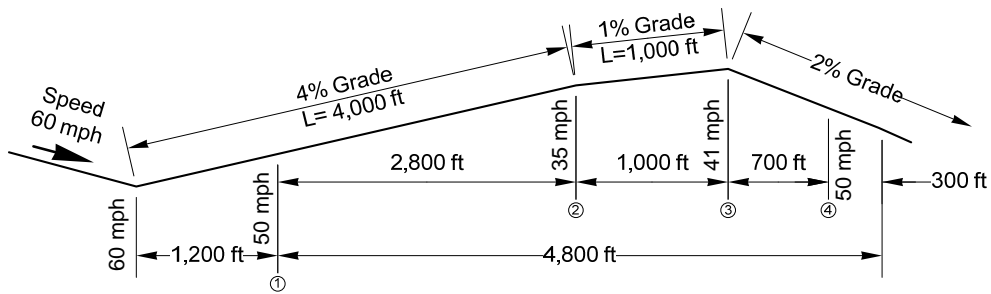
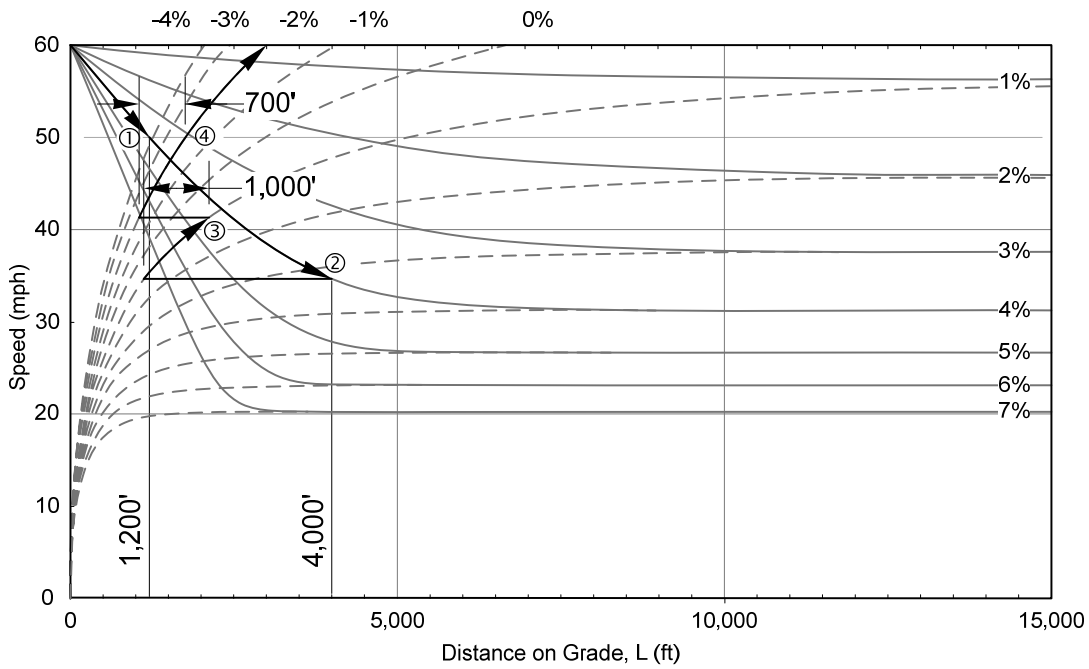

Given:

A two-lane highway meeting the level of service warrant, with the above profile, and a 60 mph posted speed.

Determine:

Is the climbing lane warranted? If so, what is its length?

Solution:

1. Follow the 4% grade deceleration curve from a speed of 60 mph to a speed of 50 mph at 1,200 ft. The speed reduction warrant is met and a climbing lane is needed.
2. Continue on the 4% grade deceleration curve to 4,000 ft. Note that the speed at the end of the 4% grade is 35 mph.
3. Follow the 1% grade acceleration curve from a speed of 35 mph for 1,000 ft. Note that the speed at the end of the 1% grade is 41 mph.
4. Follow the -2% grade acceleration curve from a speed of 41 mph to a speed of 50 mph, ending the speed reduction warrant. Note that the distance is 700 ft.
5. The total auxiliary lane length is $(4,000-1,200)+1,000+700+300=4,800$ feet. 300 ft is added to the speed reduction warrant for a two-lane highway (see 1270.04(3) and Exhibit 1270-3).

Speed Reduction Warrant Example

Exhibit 1270-2b

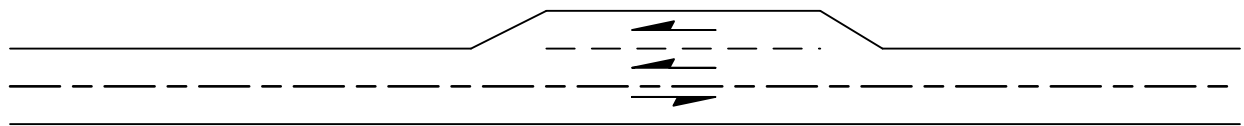

(a) Isolated Passing Lane

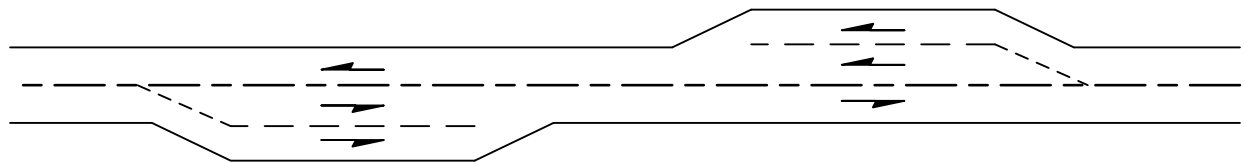

(b) Intermittent Passing Lane

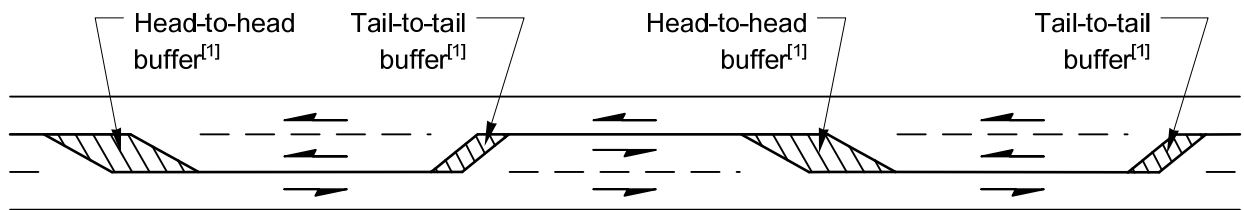

(c) Continuous Three-Lane Section

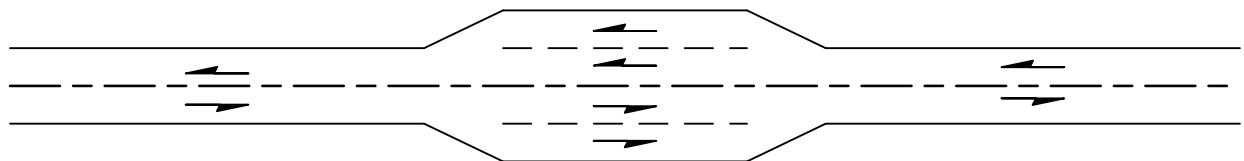

(d) Short Four-Lane Section

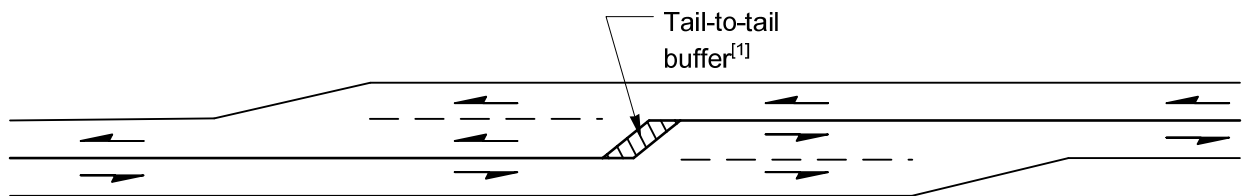

(e) Intermittent Three-Lane Passing Lanes

Notes:

[1] See Exhibit 1270-7 for buffer design.

Passing Lane Configurations

Exhibit 1270-6

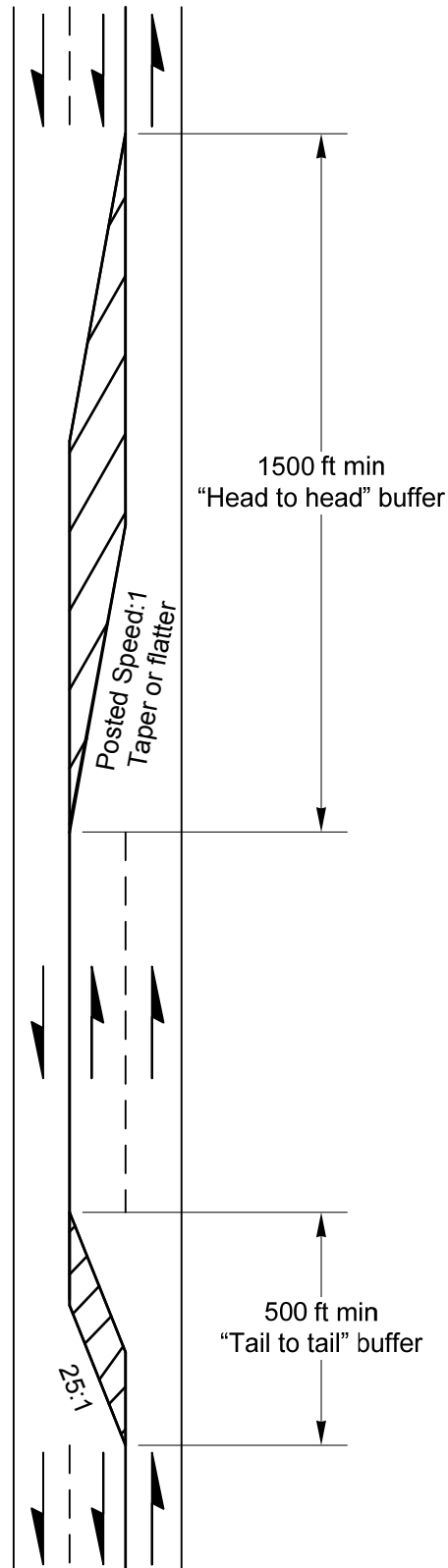

Buffer Between Opposing Passing Lanes

Exhibit 1270-7

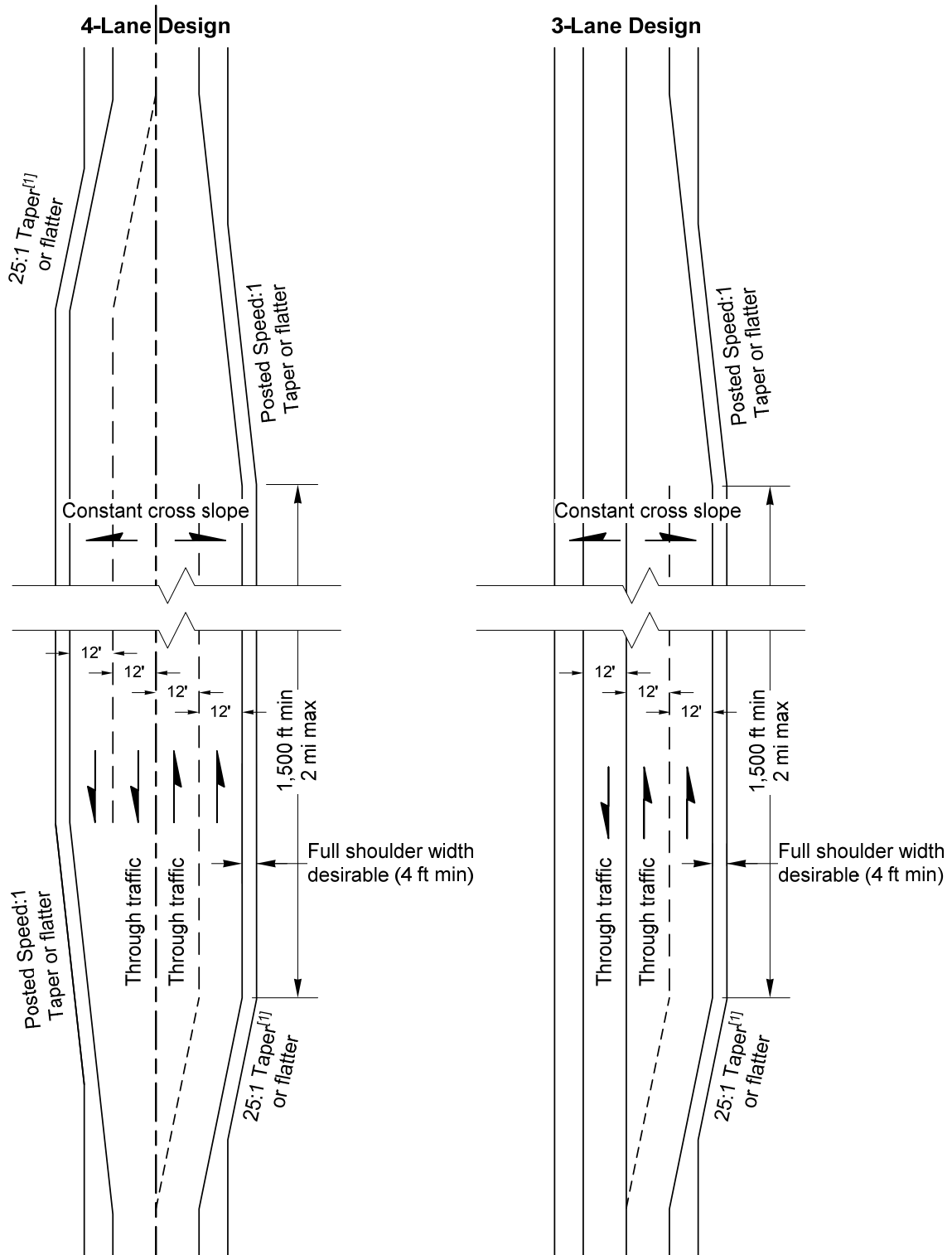

Note:

[1] Provide a posted speed:1 taper when all traffic is directed to the right lane at the beginning of the passing lane.

Auxiliary Passing Lane
Exhibit 1270-8

1270.06 Slow-Moving Vehicle Turnouts

(1) General

RCW 46.61.427 states:

On a two-lane highway where passing is unsafe ... a slow-moving vehicle, behind which five or more vehicles are formed in a line, shall turn off the roadway wherever sufficient area for a safe turn-out exists, in order to permit the vehicles following to proceed...

A slow-moving vehicle turnout is not an auxiliary lane. Its purpose is to provide sufficient room for a slow-moving vehicle to pull out of through traffic and stop if necessary, allow vehicles to pass, and then return to the through lane. Generally, a slow-moving vehicle turnout is provided on existing roadways where passing opportunities are limited, where slow-moving vehicles such as trucks and recreational vehicles are predominant, and where the cost to provide a full auxiliary lane would be prohibitive.

(2) Design

Base the design of a slow-moving vehicle turnout primarily on sound engineering judgment and Exhibit 1270-9. Designs may vary from one location to another. Provide a *minimum* length of 100 feet. The *maximum* length is ¼ mile, including tapers. Surface turnouts with a stable, unyielding material (such as BST or HMA) with adequate structural strength to support the heavier traffic.

To improve the ability of a vehicle to safely reenter through traffic, locate slow-moving vehicle turnouts where decision sight distance (see Chapter 1260) is available. With justification, slow-vehicle turnouts may be located where at least design stopping sight distance is available.

Sign slow-moving vehicle turnouts to identify their presence. For guidance, see the *Standard Plans*, the *Traffic Manual*, and the MUTCD.

When a slow-moving vehicle turnout is to be built, document the need for the turnout, the location of the turnout, and why it was selected over a passing or climbing lane.

1270.07 Shoulder Driving for Slow Vehicles

(1) General

For projects where climbing or passing lanes are justified, but are not within the scope of the project, or where meeting the warrants for these lanes is borderline, the use of a shoulder driving section is an alternative.

Review the following when considering a shoulder driving section:

- Horizontal and vertical alignment
- Character of traffic
- Presence of bicycles
- Road approaches and intersections
- Clear zone (see Chapter 1600)

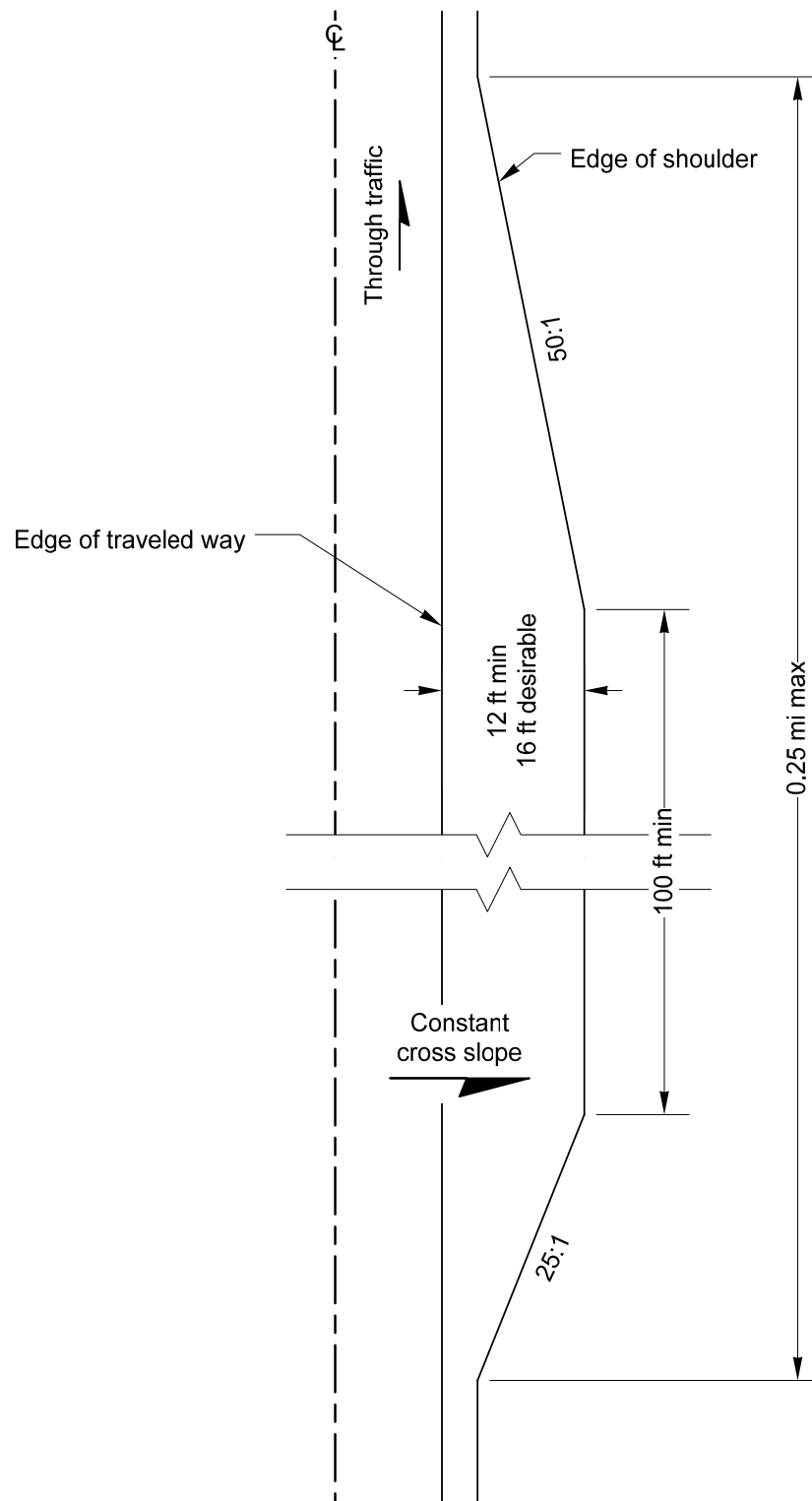

Slow-Moving Vehicle Turnout
Exhibit 1270-9

(2) Design

When designing a shoulder for shoulder driving, locate where full design stopping sight distance (speed/path/direction decision sight distance is desirable) and a minimum length of 600 feet are available. Where practicable, avoid sharp horizontal curves. When barriers or other roadside objects are present, the minimum width is 12 feet. The shoulder width depends on the vehicles that will be using the shoulder. Where trucks will be the primary vehicle using the shoulder, use a 12-foot width; when passenger cars are the primary vehicle, a 10-foot width may be used.

Shoulder driving and bicycles are not compatible. When the route has been identified as a local, state, or regional significant bike route, shoulder driving for slow vehicles is undesirable. Reconstruct the shoulders to provide adequate structural strength for the anticipated traffic. Select locations where the sideslope meets the criteria of Chapter 1230 for new construction and Chapter 1130 for existing roadways. When providing a transition at the end of a shoulder driving section, use a 50:1 taper.

Signing for shoulder driving is required (see the *Standard Plans*, the *Traffic Manual*, and the *MUTCD*). Install guideposts when shoulder driving is to be permitted at night.

Document the need for shoulder driving and why a lane is not being built.

1270.08 Emergency Escape Ramps



Emergency Escape Ramp Example
Exhibit 1270-10

(1) General

Consider an emergency escape ramp (see [Exhibit 1270-10](#)) whenever a long, steep downgrade is encountered. In this situation, the possibility exists of a truck losing its brakes and going out of control at a high speed. Consult local maintenance personnel and check traffic accident records to determine whether or not an escape ramp is justified.

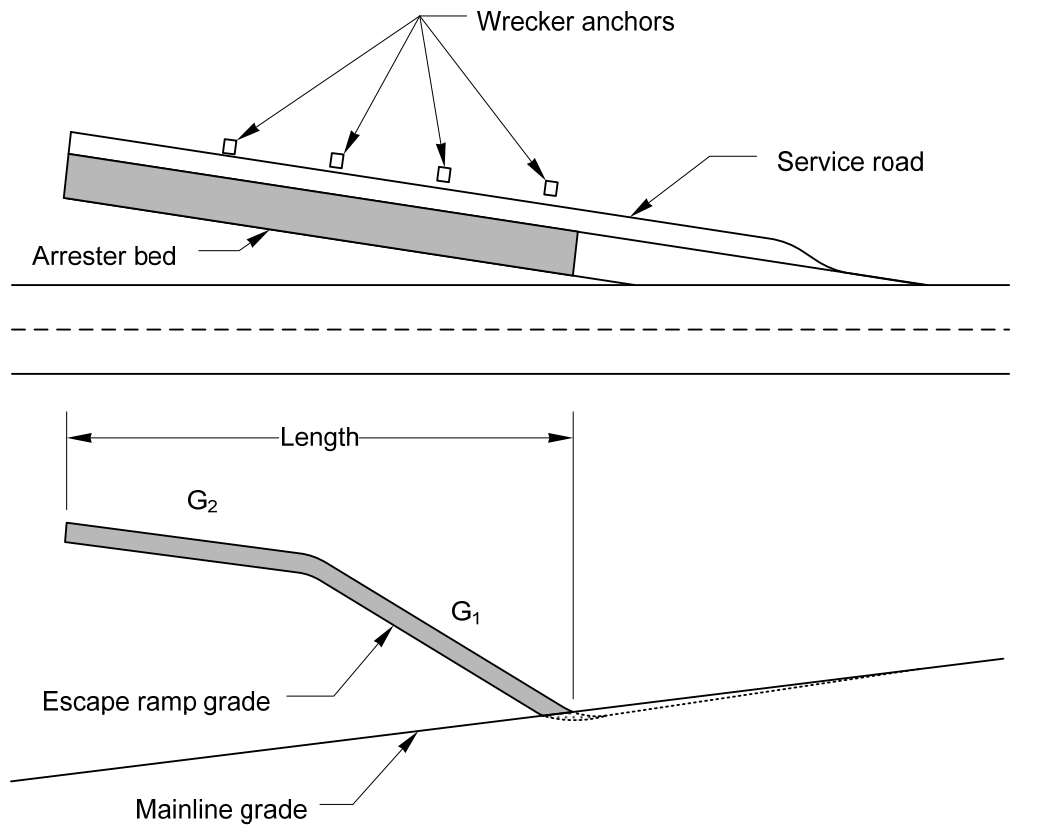

Typical Emergency Escape Ramp

Exhibit 1270-13

1270.09 Chain-Up and Chain-Off Areas

Provide chain-up areas to allow chains to be put on vehicles out of the through lanes at locations where traffic enters chain enforcement areas. Provide chain-off areas to remove chains out of the through lanes for traffic leaving chain enforcement areas.

Chain-up or chain-off areas are widened shoulders, designed as shown in Exhibit 1270-14. Locate chain-up and chain-off areas where the grade is 6% or less and desirably on a tangent section.

Consider illumination for chain-up and chain-off areas on multilane highways. When deciding whether or not to install illumination, consider traffic volumes during the hours of darkness and the availability of power.

The wide shoulders at chain-up and chain-off areas may encourage parking. When parking is undesirable, consider parking restrictions.

1270.10 Documentation

For the list of documents required to be preserved in the Design Documentation Package and the Project File, see the Design Documentation Checklist:

☞ www.wsdot.wa.gov/design/projectdev/

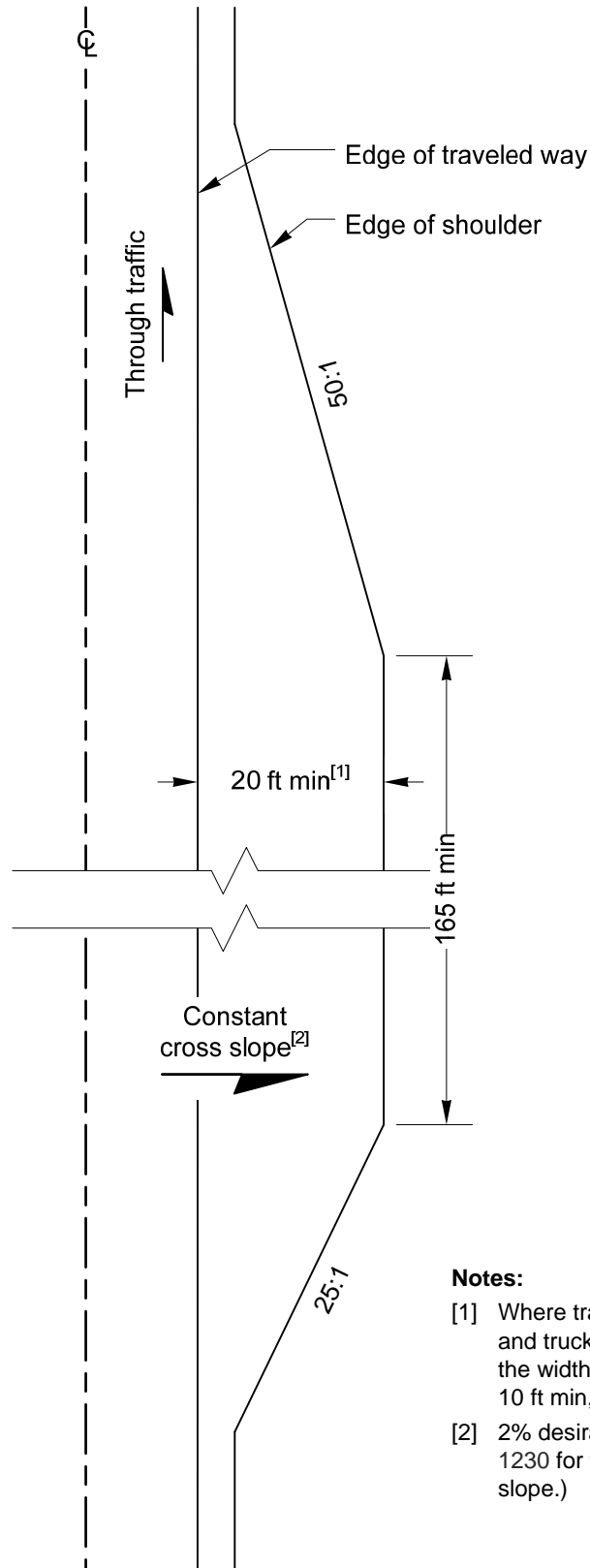

Notes:

- [1] Where traffic volumes are low and trucks are not a concern, the width may be reduced to 10 ft min, with 15 ft desirable.
- [2] 2% desirable. (See Chapter 1230 for traveled way cross slope.)

Chain Up/Chain Off Area
Exhibit 1270-14

design vehicle A vehicle used to establish the intersection geometry.

intersection angle The angle between any two intersecting legs at the point the centerlines intersect.

intersection area The area of the intersecting roadways bounded by the edge of traveled ways and the area of the adjacent roadways to the farthest point: (a) the end of the corner radii, (b) through any marked crosswalks adjacent to the intersection, (c) to the stop bar, or (d) 10 feet from the edge of shoulder of the intersecting roadway (see Exhibit 1310-1).

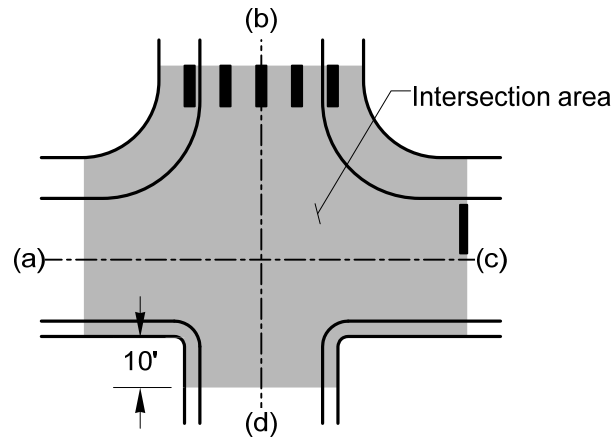

Intersection Area
Exhibit 1310-1

intersection at grade The general area where a roadway or ramp terminal is met or crossed at a common grade or elevation by another roadway.

four-leg intersection An intersection formed by two crossing roadways.

split tee A four-leg intersection with the crossroad intersecting the through roadway at two tee intersections offset by at least the width of the roadway.

tee (T) intersection An intersection formed by two roadways where one roadway terminates at the point it meets a through roadway.

wye (Y) intersection An intersection formed by three legs in the general form of a "Y" where the angle between two legs is less than 60°.

intersection leg Any one of the roadways radiating from and forming part of an intersection.

entrance leg The lanes of an intersection leg for traffic entering the intersection.

exit leg The lanes of an intersection leg for traffic leaving the intersection.

Note: Whether an intersection leg is an entrance leg or an exit leg depends on which movement is being analyzed. For two-way roadways, each leg is an entrance leg for some movements and an exit leg for other movements.

intersection sight distance The length of roadway visible to the driver of a vehicle entering an intersection.

island A defined area within an intersection, between traffic lanes, for the separation of vehicle movements or for pedestrian refuge.

roundabout A circular intersection at grade (see Chapter 1320).

rural intersection An intersection in a rural design area (see Chapter 1140).

slip ramp A connection between legs of an intersection that allows right-turning vehicles to bypass the intersection or a connection between an expressway and a parallel frontage road. These are often separated by an island.

two-way left-turn lane (TWLTL) A lane located between opposing lanes of traffic to be used by vehicles making left turns from either direction, from or onto the roadway.

urban intersection An intersection in an urban design area (see Chapter 1140).

1310.04 Intersection Configurations

At-grade intersection configurations in their simplest forms are three-leg, four-leg, and multileg. More complex designs are variations or combinations selected to accommodate the constraints and traffic presented by the location. Intersection configurations are determined by the number of intersecting legs; the topography; the character of the intersecting roadways; the traffic volumes, patterns, and speeds; and the desired type of operation.

(1) Roundabouts

Modern roundabouts are circular intersections. When well designed, they are an efficient form of intersection control. They have fewer conflict points, lower speeds, easier decision making, and need less maintenance.

When properly designed and located, roundabouts have been found to reduce injury collisions, traffic delays, fuel consumption, and air pollution. They also permit U-turns.

Include roundabouts as an alternative at intersections where:

- Stop signs result in unacceptable delays for the crossroad traffic.
- There is a high left-turn percentage.
- There are more than four legs.
- A disproportionately high number of collisions involve crossing or turning traffic.
- The major traffic movement makes a turn.
- Traffic growth is expected to be high and future traffic patterns are uncertain.
- It is not desirable to give priority to either roadway.

Other tradeoffs with roundabouts include:

- Roundabouts give equal priority to all legs.
- The design forces the entering traffic to reduce speed.

Refer to Chapter 1320 for information and criteria for the design and documentation of roundabouts.

1310.06 Design Vehicle Selection

When selecting a design vehicle for an intersection, consider the needs of all users and the costs. The primary use of the design vehicle is to determine radii for each leg of the intersection. It is possible for each leg to have a different design vehicle. Exhibit 1310-11 shows commonly used design vehicle types.

Evaluate the existing and anticipated future traffic to select a design vehicle that is the largest vehicle that normally uses the intersection. Exhibit 1310-12 shows the minimum design vehicles. Justify the decision to use a smaller vehicle; include a traffic analysis showing that the proposed vehicle is appropriate.

To minimize the disruption to other traffic, design the intersection to allow the design vehicles to make each turning movement without encroaching on curbs, opposing lanes, or same-direction lanes at the entrance leg. Use turning path templates (Exhibits 1310-13a through 13c, other published templates, or computer-generated templates) to verify that the design vehicle can make the turning movements.

Encroachment on the same-direction lanes of the exit leg and the shoulder might be necessary to minimize crosswalk distances; however, this might negatively impact vehicular operations. Justify the operational tradeoffs associated with this encroachment. When encroachment on the shoulder is required, increase the pavement structure to support the anticipated traffic.

Vehicle Type	Design Symbol
Passenger car, including light delivery trucks	P
Single-unit bus	BUS
Articulated bus	A-BUS
Single-unit truck	SU
Semitrailer truck, overall wheelbase of 40 ft	WB-40
Semitrailer truck, overall wheelbase of 50 ft	WB-50
Semitrailer truck, overall wheelbase of 67 ft	WB-67
Motor home	MH
Passenger car pulling a camper trailer	P/T
Motor home pulling a boat trailer	MH/B

Design Vehicle Types
Exhibit 1310-11

Intersection Type	Minimum Design Vehicle
Junction of Major Truck Routes	WB-67
Junction of State Routes	WB-50 ^[1]
Ramp Terminals	WB-50 ^[1]
Other Rural	WB-50
Industrial	WB-40
Commercial	SU ^{[2][3]}
Residential	SU ^{[2][3]}
Notes:	
[1] WB-67 is desirable.	
[2] To accommodate pedestrians, the P vehicle may be used as the design vehicle <u>when justified in</u> a traffic analysis.	
[3] When the intersection is on a transit or school bus route, use the BUS design vehicle as a minimum. (See Chapter 1430 for additional guidance on transit facilities.)	

Minimum Intersection Design Vehicle

Exhibit 1310-12

In addition to the design vehicle, design intersections to accommodate the occasional larger vehicle. When vehicles larger than the design vehicle are allowed and are anticipated to occasionally use the intersection, make certain they can make the turn without leaving the paved shoulders or encroaching on a sidewalk. The amount of encroachment allowed is dependent on the frequency of vehicle usage and the resulting disruption to other traffic. Use the WB-67 as the largest vehicle at state route-to-state route junctions. Consider oversized vehicles for intersections that are commonly used to route oversized loads. Justify any required encroachment into other lanes and any degradation of intersection operation in an evaluate upgrade.

1310.07 Design Elements

When designing an intersection, identify and address the needs of all intersection users.

When pedestrian issues are a primary concern, the design objective becomes one of reducing the potential for vehicle/pedestrian conflicts. This is done by minimizing pedestrian crossing distances and controlling the speeds of turning vehicles. This normally leads to right-corner designs with smaller turning radii. The negative impacts include possible capacity reductions and greater speed differences between turning vehicles and through vehicles.

Pedestrian refuge islands can be beneficial. They minimize the pedestrian crossing distance, reduce the conflict area, and minimize the impacts on vehicular traffic. When designing islands, speeds can be reduced by designing the turning roadway with a taper or large radius curve at the beginning of the turn and a small radius curve at the end. This allows larger islands while forcing the turning traffic to slow down.

Channelization, the separation or regulation of traffic movements into delineated paths of travel, can facilitate the orderly movement of vehicles, bicycles, and pedestrians. Channelization includes left-turn lanes, right-turn lanes, speed change lanes (both acceleration and deceleration lanes), and islands.

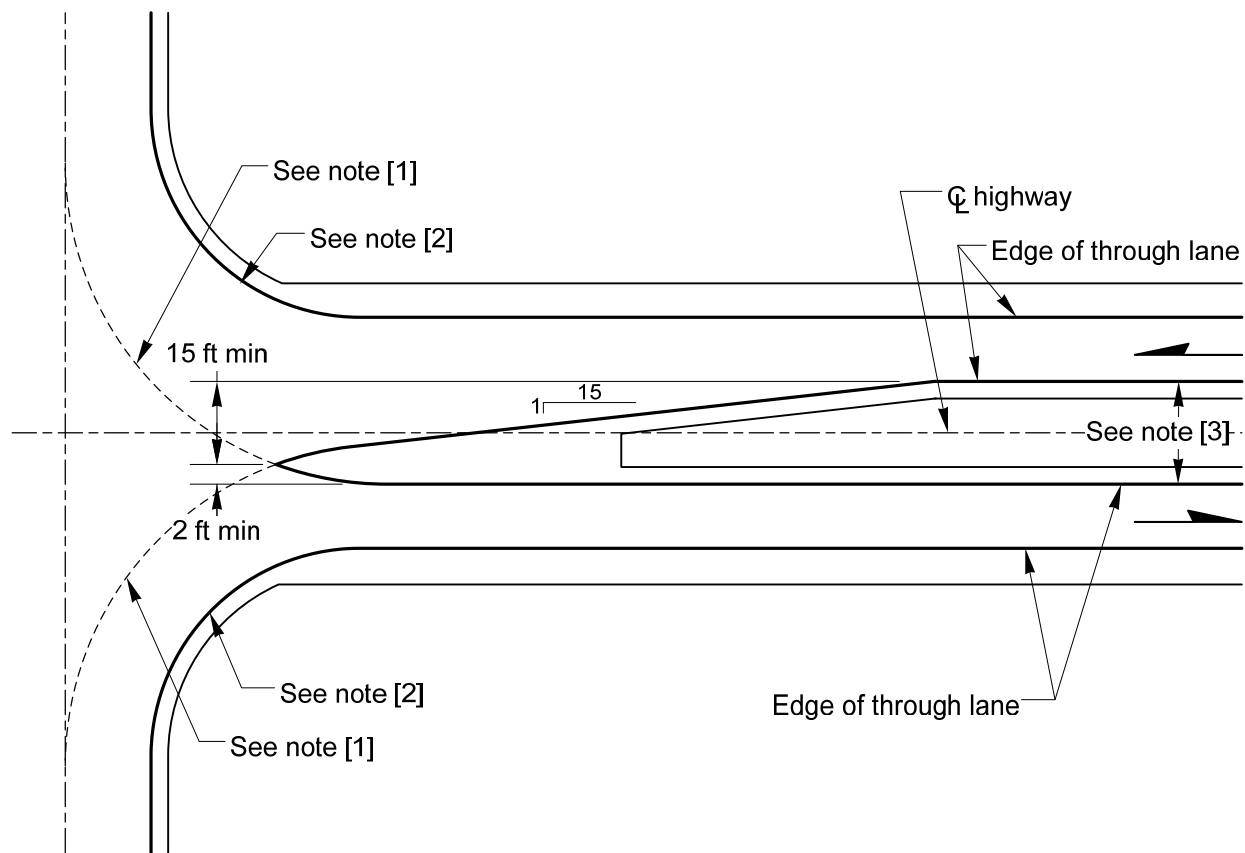
**Notes:**

- [1] Desirable radius not less than 50 ft. Use templates to verify that the design vehicle can make the turn.
 [2] For right-turn corner design, see Exhibit 1310-14.
 [3] For median width 17 ft or more. For median width less than 17 ft, widen to 17 ft or use Exhibit 1310-18b.

General:

For pavement marking details, see the *Standard Plans* and the MUTCD.

Median Channelization: Minimum Protected Storage

Exhibit 1310-18e

(b) Two-Way Left-Turn Lanes (TWLTL)

Two-way left-turn lanes are located between opposing lanes of traffic. They are used by vehicles making left turns from either direction, from or onto the roadway.

Use TWLTLs only on managed access highways where there are no more than two through lanes in each direction. Evaluate installation of TWLTLs where:

- A collision study indicates reduced crashes with a TWLTL.
- There are existing closely spaced access points or minor street intersections.
- There are unacceptable through traffic delays or capacity reductions because of left-turning vehicles.

TWLTLs can reduce delays to through traffic, reduce rear-end collisions, and provide separation between opposing lanes of traffic. However, they do not provide refuge for pedestrians and can encourage strip development with additional closely spaced access points. Evaluate other alternatives (such as prohibiting midblock left turns and providing for U-turns) before using a TWLTL. (See Chapters 1140 and 540 for additional restrictions on the use of TWLTLs.)

The basic design for a TWLTL is illustrated in Exhibit 1310-18f. Additional criteria are as follows:

- The desirable length of a TWLTL is not less than 250 feet.
- Provide illumination in accordance with the guidelines in Chapter 1040.
- Pavement markings, signs, and other traffic control devices must be in accordance with the MUTCD and the *Standard Plans*.
- Provide clear channelization when changing from TWLTLs to one-way left-turn lanes at an intersection.

(3) Right-Turn Lanes

Right-turn movements influence intersection capacity even though there is no conflict between right-turning vehicles and opposing traffic. Right-turn lanes might be needed to maintain efficient intersection operation. Use the following to determine when to provide right-turn lanes at unsignalized intersections:

- For two-lane roadways and for multilane roadways with a posted speed of 45 mph or above, when recommended by Exhibit 1310-19.
- A collision study indicates an overall crash reduction with a right-turn lane.
- The presence of pedestrians requires right-turning vehicles to stop.
- Restrictive geometrics require right-turning vehicles to slow greatly below the speed of the through traffic.
- There is less than decision sight distance for traffic approaching the intersection.

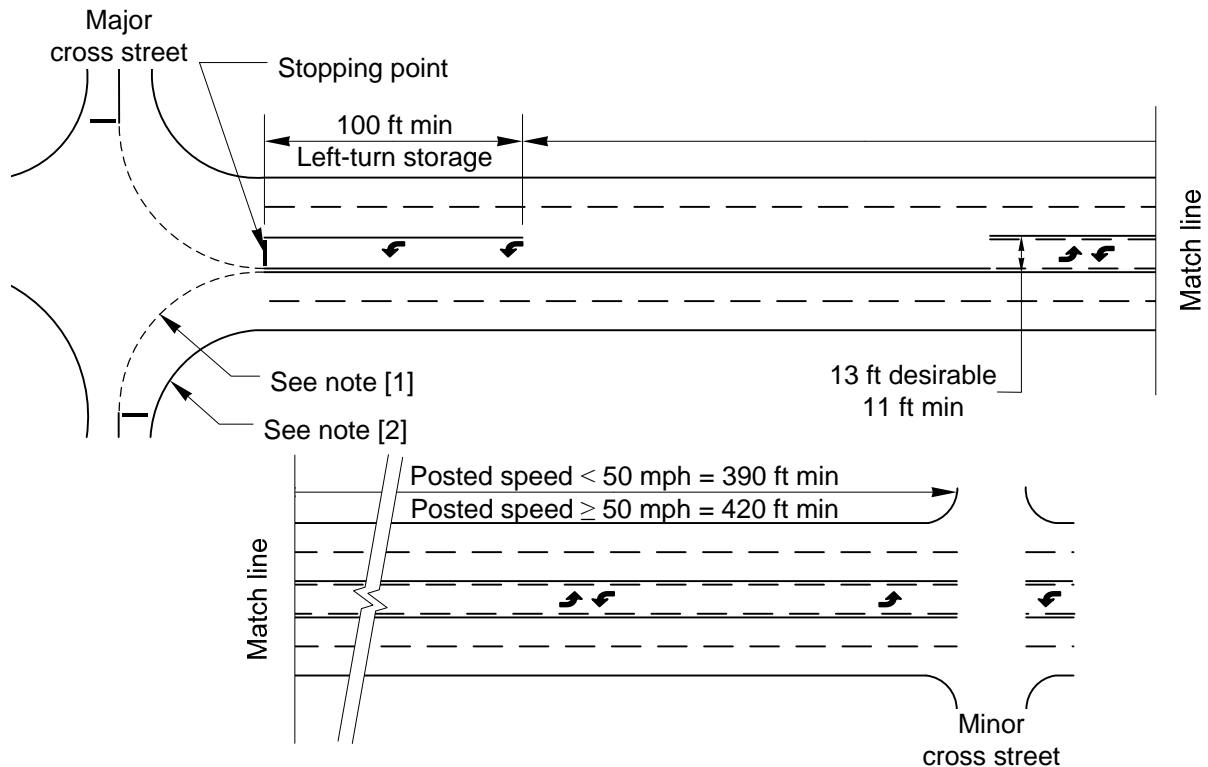
**Notes:**

- [1] Desirable radius not less than 50 ft. Use templates to verify that the design vehicle can make the turn.
 [2] For right-turn corner design, see Exhibit 1310-14.

General:

For pavement marking details and signing criteria, see the *Standard Plans* and the MUTCD.

Median Channelization: Two-Way Left-Turn Lane*Exhibit 1310-18f*

For unsignalized intersections, see 1310.07(4) for guidance on right-turn lane lengths. For signalized intersections, use a traffic signal analysis to determine whether a right-turn lane is needed and what the length is (see Chapter 1330).

A capacity analysis may be used to determine whether right-turn lanes are needed to maintain the desired level of service.

Where adequate right of way exists, providing right-turn lanes is relatively inexpensive and can provide increased operational efficiency.

The right-turn pocket or the right-turn taper (see Exhibit 1310-20) may be used at any minor intersection where a right-turn lane is not provided. These designs reduce interference and delay to the through movement by offering an earlier exit to right-turning vehicles.

If the right-turn pocket is used, Exhibit 1310-20 shows taper lengths for various posted speeds.

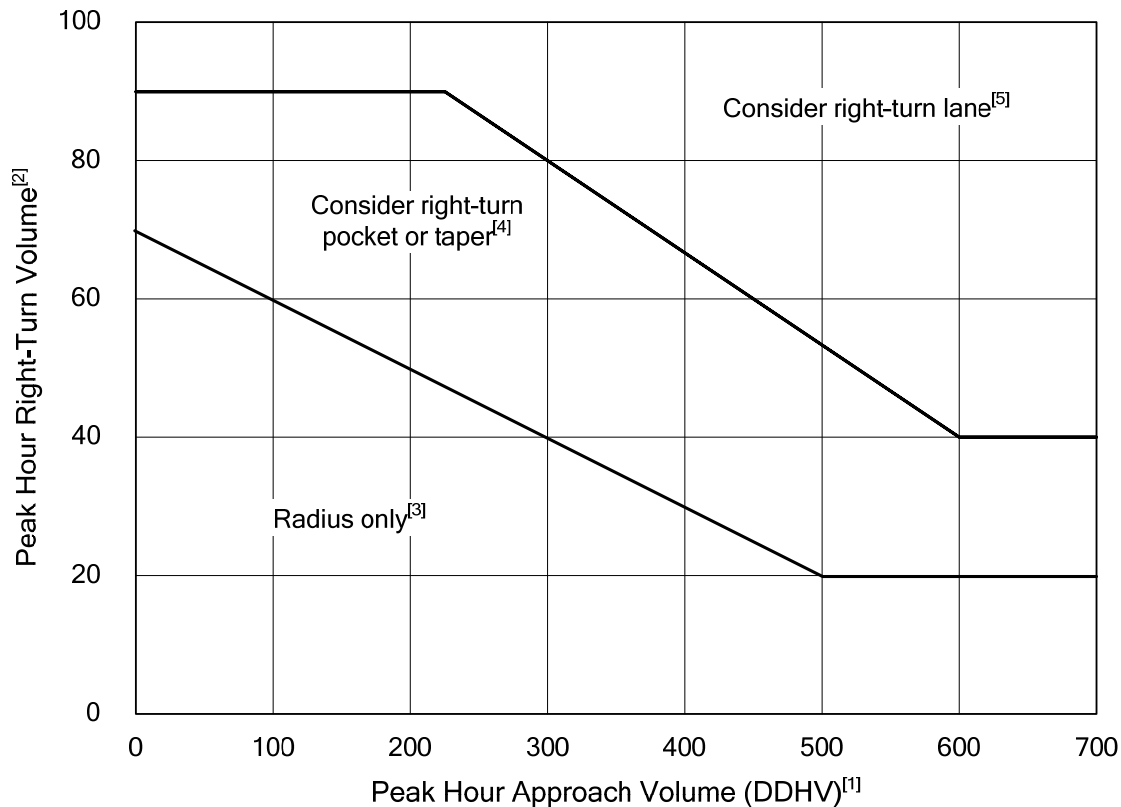
**Notes:**

- [1] For two-lane highways, use the peak hour DDHV (through + right-turn).
For multilane, high-speed highways (posted speed 45 mph or above), use the right-lane peak hour approach volume (through + right-turn).
- [2] When all three of the following conditions are met, reduce the right-turn DDHV by 20:
- The posted speed is 45 mph or below
 - The right-turn volume is greater than 40 VPH
 - The peak hour approach volume (DDHV) is less than 300 VPH
- [3] For right-turn corner design, see Exhibit 1310-14.
- [4] For right-turn pocket or taper design, see Exhibit 1310-20.
- [5] For right-turn lane design, see Exhibit 1310-21.

General:

For additional guidance, see 1310.07(3).

Right-Turn Lane Guidelines^[6]

Exhibit 1310-19

(4) Speed Change Lanes

A speed change lane is an auxiliary lane primarily for the acceleration or deceleration of vehicles entering or leaving the through traveled way. Speed change lanes are normally provided for at-grade intersections on multilane divided highways with access control. Where roadside conditions and right of way allow, speed change lanes may be provided on other through roadways. Justification for a speed change lane depends on many factors, including speed; traffic volumes; capacity; type of highway; design and frequency of intersections; and collision history.

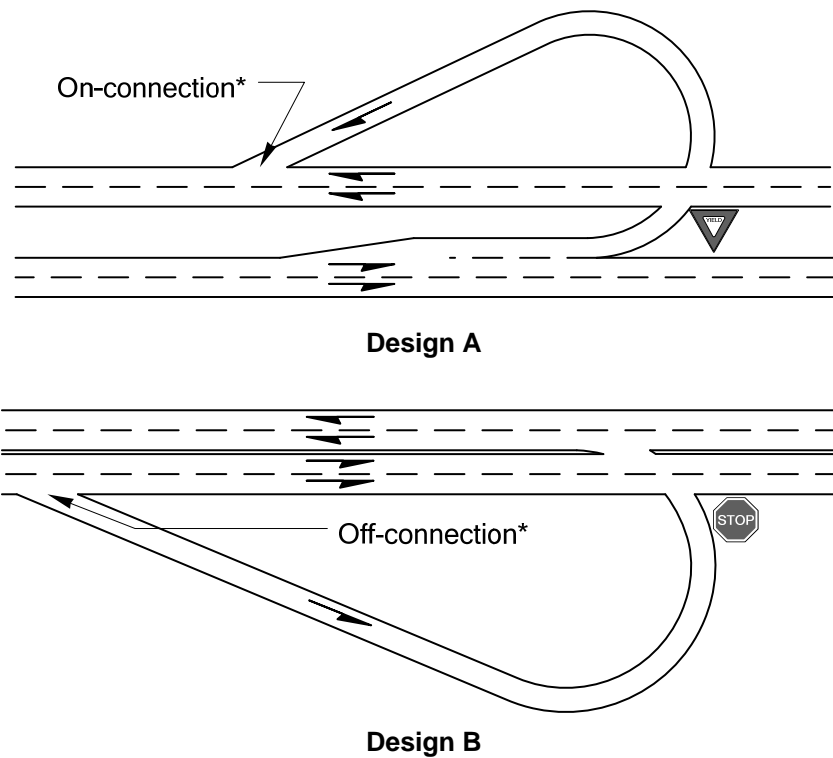

*Design on- and off-connections in accordance with Chapter 1360.

U-Turn Roadway Exhibit 1310-25

Document the need for U-turn locations, the spacing used, and the selected design vehicle. If the design vehicle is smaller than the largest vehicle using the facility, provide an alternate route.

U-turns at signal-controlled intersections do not need the acceleration lanes shown in Exhibit 1310-26. For new U-turn locations at signal-controlled intersections, evaluate conflicts between right-turning vehicles from side streets and U-turning vehicles. Warning signs on the cross street might be appropriate.

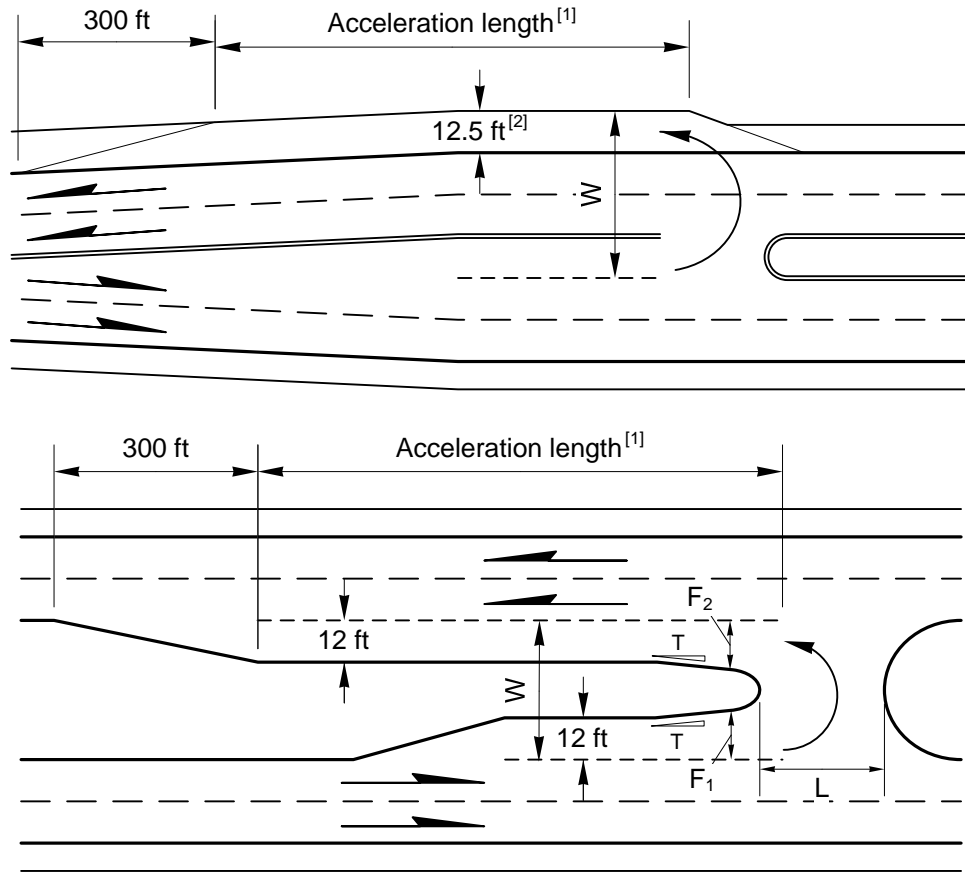

Vehicle	W	R	L	F ₁	F ₂	T
P	52	14	14	12	12	—
SU	87	30	20	13	15	10:1
BUS	87	28	23	14	18	10:1
WB-40	84	25	27	15	20	6:1
WB-50	94	26	31	16	25	6:1
WB-67	94	22	49	15	35	6:1
MH	84	27	20	15	16	10:1
P/T	52	11	13	12	18	6:1
MH/B	103	36	22	15	16	10:1
U-Turn Design Dimensions						

Notes:

- [1] The minimum length of the acceleration lane is shown in Exhibit 1310-22. Acceleration lane may be eliminated at signal-controlled intersections.
- [2] When U-turn uses the shoulder, provide 12.5-ft shoulder width and shoulder pavement designed to the same depth as the through lanes for the acceleration length and taper.

General:

All dimensions are in feet.

U-Turn Median Openings

Exhibit 1310-26

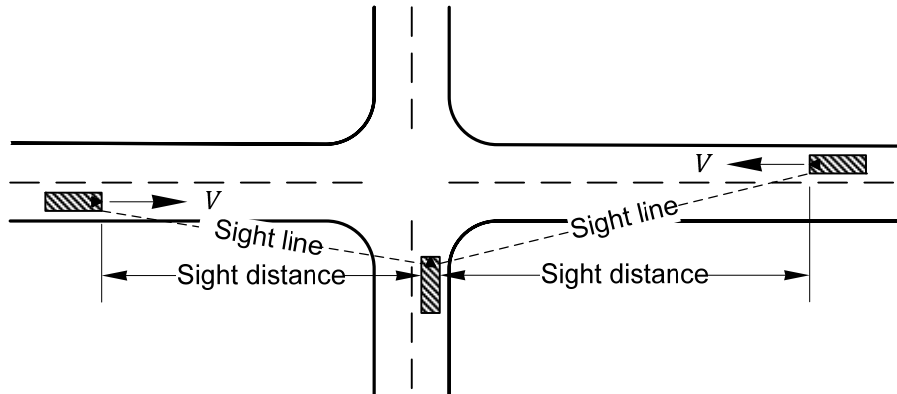

$S_i = 1.47Vt_g$
Where: S_i = Intersection sight distance (ft) V = Design speed of the through roadway (mph) t_g = Time gap for the minor roadway traffic to enter or cross the through roadway (sec)

Intersection Sight Distance Equation
 Table 1

Design Vehicle	Time Gap (t_g) in Sec
Passenger car (P)	7.5
Single-unit trucks and buses (SU & BUS)	9.5
Combination trucks (WB-40, WB-50, & WB-67)	11.5
Note: Values are for a stopped vehicle to turn left onto a two-lane two-way roadway with no median and grades 3% or less.	

Intersection Sight Distance Gap Times (t_g)
 Table 2

Adjust the t_g values listed in Table 2 as follows:

Crossing or right-turn maneuvers:

All vehicles subtract 1.0 sec

Multilane roadways:

Left turns, for each lane in excess of one to be crossed, and for medians wider than 4 ft:

Passenger cars add 0.5 sec
 All trucks and buses add 0.7 sec

Crossing maneuvers, for each lane in excess of two to be crossed, and for medians wider than 4 ft:

Passenger cars add 0.5 sec
 All trucks and buses add 0.7 sec

Note: Where medians are wide enough to store the design vehicle, determine the sight distance as two maneuvers.

Crossroad grade greater than 3%:

All movements upgrade for each percent that exceeds 3%:

All vehicles add 0.2 sec

Sight Distance at Intersections
 Exhibit 1310-27a

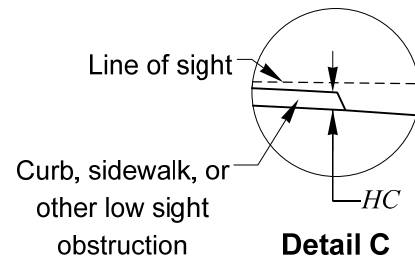
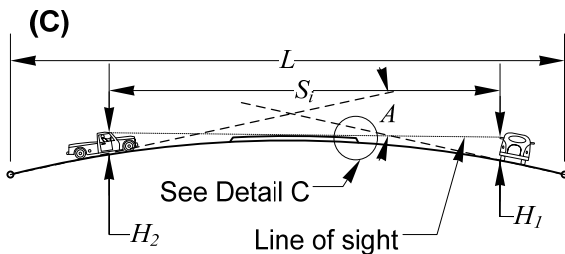
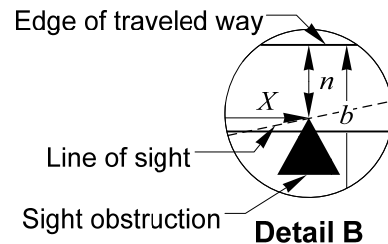
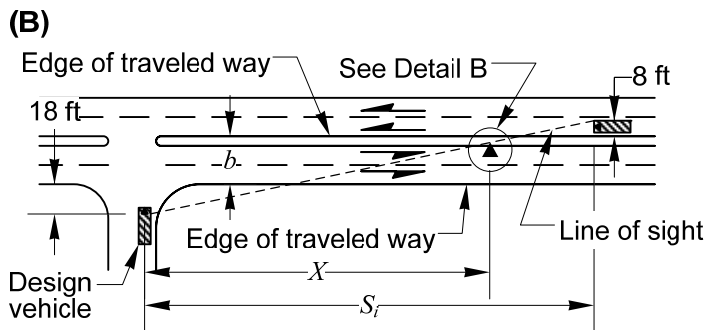
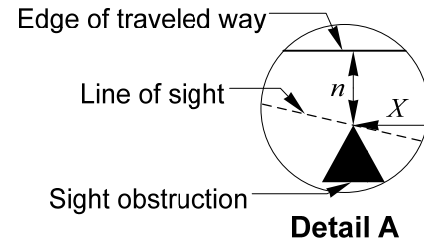
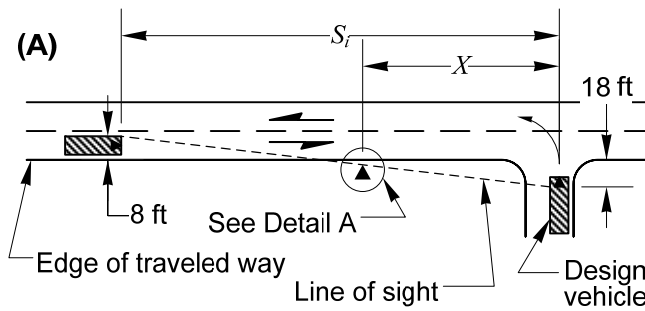

For sight obstruction driver cannot see over:

$$S_i = \frac{(26+b)(X)}{(18+b-n)}$$

Where:

- S_i = Available intersection sight distance (ft)
- n = Offset from sight obstruction to edge of lane (ft)
- b = Distance from near edge of traveled way to near edge of lane approaching from right (ft) ($b=0$ for sight distance to the left)
- X = Distance from centerline of lane to sight obstruction (ft)

For crest vertical curve over a low sight obstruction when $S < L$:

$$S_i = \sqrt{\frac{100L[\sqrt{2(H_1 - HC)} + \sqrt{2(H_2 - HC)}]^2}{A}}$$

$$L = \frac{AS_i^2}{100[\sqrt{2(H_1 - HC)} + \sqrt{2(H_2 - HC)}]^2}$$

Where:

- S_i = Available sight distance (ft)
- H_1 = Eye height (3.5 ft for passenger cars; 6 ft for all trucks)
- H_2 = Object height (3.5 ft)
- HC = Sight obstruction height (ft)
- L = Vertical curve length (ft).
- A = Algebraic difference in grades (%)

Sight Distance at Intersections

Exhibit 1310-27b

1310.10 Traffic Control at Intersections

Intersection traffic control is the process of moving traffic through areas of potential conflict where two or more roadways meet. Signs, signals, channelization, and physical layout are the major tools used to establish intersection control.

(1) Intersection Traffic Control Objectives

There are three objectives to intersection traffic control that can greatly improve intersection operations.

(a) Maximize Intersection Capacity

Since two or more traffic streams cross, converge, or diverge at intersections, the capacity of an intersection is normally less than the roadway between intersections. It is usually necessary to assign right of way through the use of traffic control devices to maximize capacity for all users of the intersection. Turn prohibitions may be used to increase intersection capacity.

(b) Reduce Conflict Points

The crossing, converging, and diverging of traffic creates conflicts that increase the potential for collisions. Establishing appropriate controls can reduce the possibility of two cars attempting to occupy the same space at the same time. Pedestrian collision potential can also be reduced by appropriate controls.

(c) Prioritize Major Street Traffic

Traffic on major routes is normally given the right of way over traffic on minor streets to increase intersection operational efficiency. If a signal is being considered or exists at an intersection that is to be modified, provide a preliminary signal plan (see Chapter 1330). If a new signal permit is required, obtain approval before the design is approved.

(2) Analysis of Alternatives

Prior to proceeding with the design, provide an analysis of alternatives for a proposal to install a traffic signal or a roundabout on a state route, either NHS or Non-NHS, with a posted speed limit of 45 mph or higher, approved by the region Traffic Engineer, with review and comment by the HQ Design Office. Include the following alternatives in the analysis:

- Channelization: deceleration lanes, storage, and acceleration lanes for left- and right-turning traffic.
- Right-off/right-on with U-turn opportunities.
- Grade separation.
- Roundabouts.
- Traffic control signals.

Include a copy of the analysis with the preliminary signal plan or roundabout justification.

1310.11 **Signing and Delineation**

Use the MUTCD and the *Standard Plans* for signing and delineation criteria. Provide a route confirmation sign on all state routes shortly after major intersections. (See Chapter 1020 for additional information on signing.)

Painted or plastic pavement markings are normally used to delineate travel paths. For pavement marking details, see the MUTCD, Chapter 1030, and the *Standard Plans*.

Contact the region or HQ Traffic Office for additional information when designing signing and pavement markings.

1310.12 **Procedures**

Document design decisions and conclusions in accordance with Chapter 300. For highways with limited access control, see Chapter 530.

(1) Approval

An intersection is approved in accordance with Chapter 300. Complete the following items, as needed, before intersection approval:

- Traffic analysis
- Deviations approved in accordance with Chapter 300
- Approved Traffic Signal Permit (DOT Form 242-014 EF) (see Chapter 1330)

(2) Intersection Plans

Provide intersection plans for any increases in capacity (turn lanes) at an intersection, modification of channelization, or change of intersection geometrics. Support the need for intersection or channelization modifications with history; school bus and mail route studies; hazardous materials route studies; pedestrian use; public meeting comments; and so forth.

For information to be included on the intersection plan for approval, see the Intersection/Channelization Plan for Approval Checklist on the following website:

www.wsdot.wa.gov/design/projectdev/

(3) Local Agency or Developer-Initiated Intersections

There is a separate procedure for local agency or developer-initiated projects at intersections with state routes. The project initiator submits an intersection plan and the documentation of design decisions that led to the plan to the region for approval. For those plans requiring a design variance, the deviation or evaluate upgrade must be approved in accordance with Chapter 300 prior to approval of the plan. After the plan approval, the region prepares a construction agreement with the project initiator (see the *Utilities Manual*).

1310.13 **Documentation**

For the list of documents required to be preserved in the Design Documentation Package and the Project File, see the Design Documentation Checklist:

www.wsdot.wa.gov/design/projectdev/

- 1320.01 General
- 1320.02 References
- 1320.03 Definitions
- 1320.04 Roundabout Types
- 1320.05 Capacity Analysis
- 1320.06 Geometric Design
- 1320.07 Pedestrians
- 1320.08 Bicycles
- 1320.09 Signing and Pavement Marking
- 1320.10 Illumination
- 1320.11 Access, Parking, and Transit Facilities
- 1320.12 Design Procedures
- 1320.13 Documentation

1320.01 General

Modern roundabouts are circular intersections at grade. They are an effective intersection type with fewer conflict points and lower speeds, and they provide for easier decision making than conventional intersections. They also require less maintenance than traffic signals. Well-designed roundabouts have been found to reduce crashes (especially fatal and severe injury collisions), traffic delays, fuel consumption, and air pollution. They also have a traffic-calming effect. For additional information and details on roundabouts, see *Roundabouts: An Informational Guide*.

Selection of a roundabout is based on an analysis of traffic volumes, traffic patterns, space needs, and right of way availability.

Modern roundabouts differ from older circular intersections in three ways: they have splitter islands that provide entry deflection to slow down entering vehicles; they have yield-at-entry, which requires entering vehicles to yield to vehicles in the roundabout to allow free flow of circulating traffic; and they have a smaller diameter that constrains circulating speeds.

1320.02 References

(1) *Federal/State Laws and Codes*

Americans with Disabilities Act of 1990 (ADA)

Revised Code of Washington (RCW) 47.05.021, Functional classification of highways

Washington Administrative Code (WAC) 468-58-080, Guides for control of access on crossroads and interchange ramps

(2) Design Guidance

ADA Accessibility Guidelines for Buildings and Facilities (ADAAG), U.S. Access Board [∞ www.access-board.gov/adaag/html/adaag.htm](http://www.access-board.gov/adaag/html/adaag.htm)

ADA Standards for Accessible Design, U.S. Department of Justice
[∞ www.usdoj.gov/crt/ada/adahom1.htm](http://www.usdoj.gov/crt/ada/adahom1.htm)

Local Agency Guidelines (LAG), M 36-63, WSDOT

Manual on Uniform Traffic Control Devices for Streets and Highways, USDOT, FHWA, as adopted and modified by Chapter 468-95 WAC “Manual on uniform traffic control devices for streets and highways” (MUTCD)

Standard Plans for Road, Bridge, and Municipal Construction (Standard Plans), M 21-01, WSDOT

Standard Specifications for Road, Bridge, and Municipal Construction (Standard Specifications), M 41-10, WSDOT

(3) Supporting Information

A Policy on Geometric Design of Highways and Streets (Green Book), AASHTO, 2004

“Crash Reductions Following Installation of Roundabouts in the United States,” Insurance Institute for Highway Safety, March 2000

[∞ www.nysdot.gov/portal/page/portal/main/roundabouts/files/insurance_report.pdf](http://www.nysdot.gov/portal/page/portal/main/roundabouts/files/insurance_report.pdf)

Guide to Traffic Engineering Practice, Part 6 – Roundabouts (Austroad Guide), Sydney, Australia: Austroad, 1993

Highway Capacity Manual (HCM), Special Report 209, Transportation Research Board, National Research Council

Modern Roundabout Practice in the United States, NCHRP Synthesis 264, Transportation Research Board, 1998

[∞ onlinepubs.trb.org/onlinepubs/nchrp/nchrp_syn_264.pdf](http://onlinepubs.trb.org/onlinepubs/nchrp/nchrp_syn_264.pdf)

Roundabouts: An Informational Guide, FHWA-RD-00-067, USDOT, FHWA

[∞ www.tfhrc.gov/safety/00068.htm](http://www.tfhrc.gov/safety/00068.htm)

Roundabout Design Guidelines, Ourston & Doctors, Santa Barbara, California, 1995

The Traffic Capacity of Roundabouts, TRRL Laboratory Report 942, Kimber, R.M., Crowthorne, England: Transport and Road Research Laboratory, 1980

“Use of Roundabouts,” ITE Technical Council Committee 5B-17, Feb. 1992

[∞ www.ite.org/traffic/documents/JBA92A42.pdf](http://www.ite.org/traffic/documents/JBA92A42.pdf)

The Design of Roundabouts: State of the Art Review, Brown, Mike, Transportation Research Laboratory, Department of Transport. London, HMSO, 1995

Understanding Flexibility in Transportation Design – Washington, WSDOT, 2005

[∞ www.wsdot.wa.gov/eesc/design/Urban/](http://www.wsdot.wa.gov/eesc/design/Urban/)

1320.11 Access, Parking, and Transit Facilities

No road approach connections to the circulating roadway are allowed at roundabouts unless they are designed as legs to the roundabout. It is desirable that road approaches not be located on the approach or departure legs within the length of the splitter island. The minimum distance from the circulating roadway to a road approach is controlled by corner clearance using the outside edge of the circulating roadway as the crossroad (see Chapter 540). If minimum corner clearance cannot be met, provide justification. (For additional information on limited access highways, see Chapter 530.)

If the parcel adjoins two legs of the roundabout, it is acceptable to provide a right-in/right-out driveway within the length of the splitter islands on both legs. This provides for all movements; design both driveways to accommodate their design vehicles (see Exhibit 1320-33a).

Roadways between roundabouts may have restrictive medians with left-turn access provided with U-turns at the roundabouts (see Exhibit 1320-33b).

Parking is not allowed in the circulating roadway or on the entry or exit roadway within the length of the splitter island.

Transit stops are not allowed in the circulating roadway, in the approach lanes within the length of the splitter island, or in the exit lanes prior to the crosswalk. Locate transit stops on the roadway before or after the roundabout, in a pullout or where the pavement is wide enough that a stopped bus does not block the through movement of traffic or impede sight distance.

1320.12 Design Procedures

Document roundabout design decisions and conclusions in accordance with Chapter 300. |

(1) Conceptual Design

Early coordination between the design team, region Traffic and Project Development offices, and HQ Traffic and Design offices is essential for a roundabout design layout.

(a) Conceptual Meeting

Conduct a Conceptual Meeting with the region Traffic Office, the region Project Development Engineer or Engineering Manager, and the HQ Traffic and Design offices after the traffic analysis has been completed. The intent of this meeting is to review, discuss, and evaluate alternative layouts for a roundabout before too much time and resources have been expended. The outcome of the meeting will provide sufficient information that a designer can proceed with finalizing the geometric design.

As a minimum, consider, discuss, and document the following items for the Conceptual Meeting:

1. **Project Overview**
2. **Traffic Analysis Recommendations and Conclusions**

In addition to Chapter 320, Traffic Analysis, the following items need to be documented:

- Use 20 years after the year construction is scheduled to begin as the design year of the analysis.
- Identify the approximate year a single-lane roundabout intersection level of service (LOS) will operate below the selected design LOS or require expansion.
- Identify growth rate(s) used for the design year analysis.
- Provide peak hour (both a.m. and p.m.) turning movement volumes for each leg for the existing and design year.
- Input an environmental factor of 1.1 if required by the analysis software.
- Provide pertinent reports generated (such as level of service, queue length, delay, percent stopped, and degree of saturation) from the analysis software used. (Contact the region or HQ Traffic Office for currently approved capacity analysis software. Using older software versions is not acceptable).
- Provide explanation of the impacts to traffic operations upstream and downstream of the intersection in situations where V/C exceeds 0.92.

3. **Preliminary Layout**

Provide an existing plan sheet, base map, or aerial photo (non-CADD-generated is encouraged) with the preliminary roundabout sketched at the intersection for use in evaluating current or new concepts to the roundabout layout. The intent is for the designer to quickly develop the roundabout footprint for the intersection without expending a lot of time or resources drafting PS&E-quality plans to show the design of the roundabout. Typically, revisions are needed based upon the feedback received at the Conceptual Meeting.

Use an existing plan sheet, base map, or aerial photo of sufficient scale to show existing roadway alignment and features, surrounding topographic information (may include aboveground and belowground utility elements), rights of way (existing), surrounding buildings, environmental constraints (such as wetlands), drainage, and other constraints that may impact the design of the roundabout.

4. **Design Vehicle**

Identify the design vehicle for each leg of the intersection. Include the truck types and sizes (oversized vehicles) that travel through the area (currently and in the future) and whether the roundabout is on an existing or planned truck route.

1330.03 Definitions

The various types of traffic control signals are defined below. Warning beacons, pedestrian flashing beacons, emergency signals, and ramp meter signals are energized only at specific times of the day or upon detecting a user. All other signals remain in operation at all times.

accessible pedestrian signal A device that communicates information about the “WALK” phase in audible and vibrotactile (vibrating surface that communicates information through touch, located on the accessible pedestrian signal button) formats.

conventional traffic signal A permanent or temporary installation providing alternating right of way assignments for conflicting traffic movements. At least two identical displays are required for the predominant movement on each approach.

emergency vehicle signal A special adaptation of a conventional traffic signal installed to allow for the safe movement of authorized emergency vehicles. Usually, this type of signal is installed on the highway at the entrance into a fire station or other emergency facility. The signal ensures protected entrance onto the highway for the emergency vehicle. When not providing for this movement, the signal either operates continuously (consistent with the requirements for a conventional traffic signal) or displays continuous green, which is allowed at nonintersection locations only. At least two identical displays are required per approach.

flasher warning assembly Flashing beacons that are used only to supplement an appropriate warning or regulatory sign or marker. The displays consist of two alternating flashing yellow indications.

high-speed roadway A roadway with a posted speed of 45 mph or higher.

intersection control beacon (also flashing beacon) A secondary control device, generally suspended over the center of an intersection, that supplements intersection warning signs and stop signs. One display per approach may be used; however, two displays per approach are desirable. Intersection control beacons are installed only at intersections that control two or more directions of travel.

lane control signal (reversible lanes) A special overhead signal that permits, prohibits, or warns of impending prohibition of lane use.

low-speed roadway A roadway with a posted speed of lower than 45 mph.

metering signal A signal used to control the predominant flow rate of traffic at an at-grade facility.

movable bridge signal (also drawbridge signal) A signal installed to notify traffic to stop when the bridge is opened for waterborne traffic. Movable bridge signals display continuous green when the roadway is open to vehicular traffic.

multilane approach An approach that has two or more lanes, regardless of the lane use designation.

overlapped displays Overlapped displays allow a traffic movement to operate with one or more nonconflicting phases. Most commonly, a minor street’s exclusive right-turn phase is overlapped with the nonconflicting major street’s left-turn phase. An overlapped display can be terminated after the parent phase (the main phase the overlap is associated with) terminates. An overlapped display programmed for two or more parent phases continues to display until all of the parent phases have

terminated. An overlap is made up of two or more phases—not one phase controlling two movements.

pedestrian signal An adaptation of a conventional traffic signal installed at established pedestrian crossings. It is used to provide a protected phase for pedestrians by terminating the conflicting vehicular movements to allow for pedestrian crossings.

portable traffic signal A type of conventional traffic signal used in work zones to control traffic. This signal is most commonly used on two-way two-lane highways where one lane has been closed for roadwork. This signal is most commonly operated in pairs, with one signal at each end of the work zone. This eliminates the need for 24-hour flagger control. The traffic signal provides alternating right of way assignments for conflicting traffic movements. The signal has an adjustable vertical support with two three-section signal displays and is mounted on a mobile trailer with its own power source.

ramp meter signal A signal used to control the flow rate of traffic entering a freeway or similar facility. A minimum of two displays is required for each approach. On single-lane ramps, a Type RM signal pole with two three-section signal heads is normally installed. On double-lane ramps, a Type II signal pole with two three-section signal heads is normally installed. When not in use, ramp meter signals are not energized.

speed limit sign beacon A beacon installed with a fixed or variable speed limit sign. The preferred display is two flashing yellow indications.

stop sign beacon A beacon installed above a stop sign. The display is a flashing red indication.

temporary traffic signal A conventional traffic signal used during construction to control traffic at an intersection while a permanent signal system is being constructed. A temporary traffic signal is typically an inexpensive span-wire installation using timber strain poles.

queue cutter traffic signal A traffic signal used at highway-rail grade crossings where the queue from a downstream traffic signal is expected to extend within the Minimum Track Clearance Distance. It is used to keep vehicles from an adjacent signalized intersection from queuing on the railroad tracks.

warning beacon A beacon that supplements a warning or regulatory sign or marking. The display is a flashing yellow indication. These beacons are not used with STOP, YIELD, or DO NOT ENTER signs or at intersections that control two or more lanes of travel. A warning identification beacon is energized only during those times when the warning or regulation is in effect.

1330.04 Procedures

(1) Permit

State statutes (RCWs) require Washington State Department of Transportation (WSDOT) approval for the design and location of all conventional traffic signals and some types of beacons located on city streets forming parts of state highways. Approval by WSDOT for the design, location, installation, and operation of all other traffic control signals installed on state highways is required by department policy.

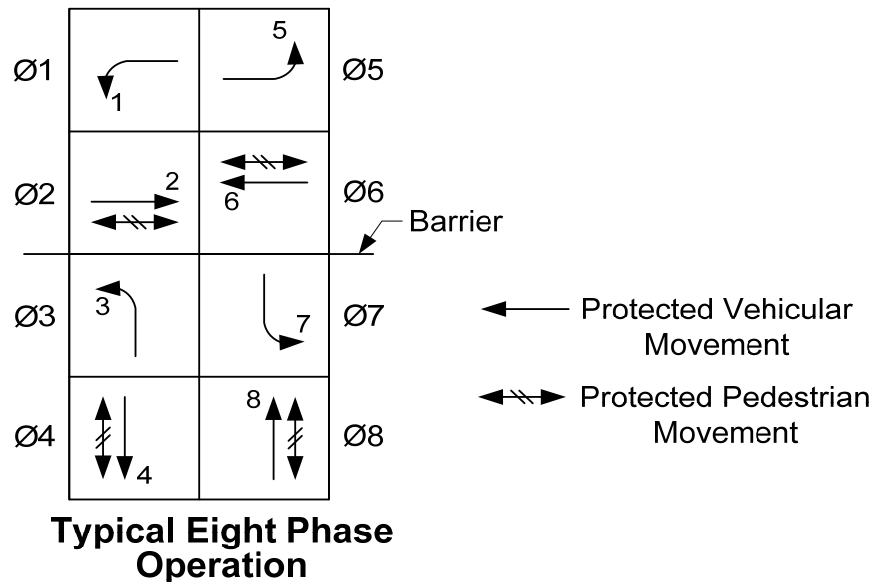
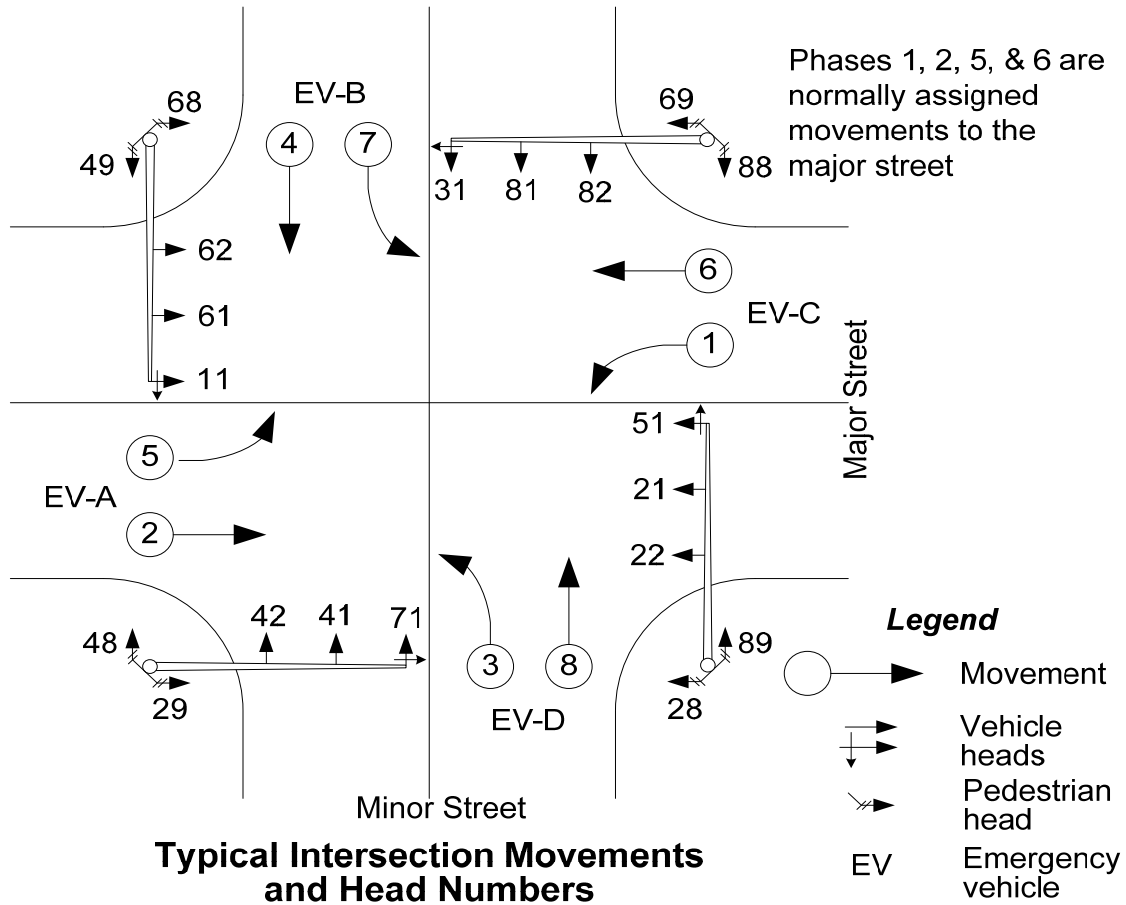

Standard Intersection Movements and Head Numbers
 Exhibit 1330-2

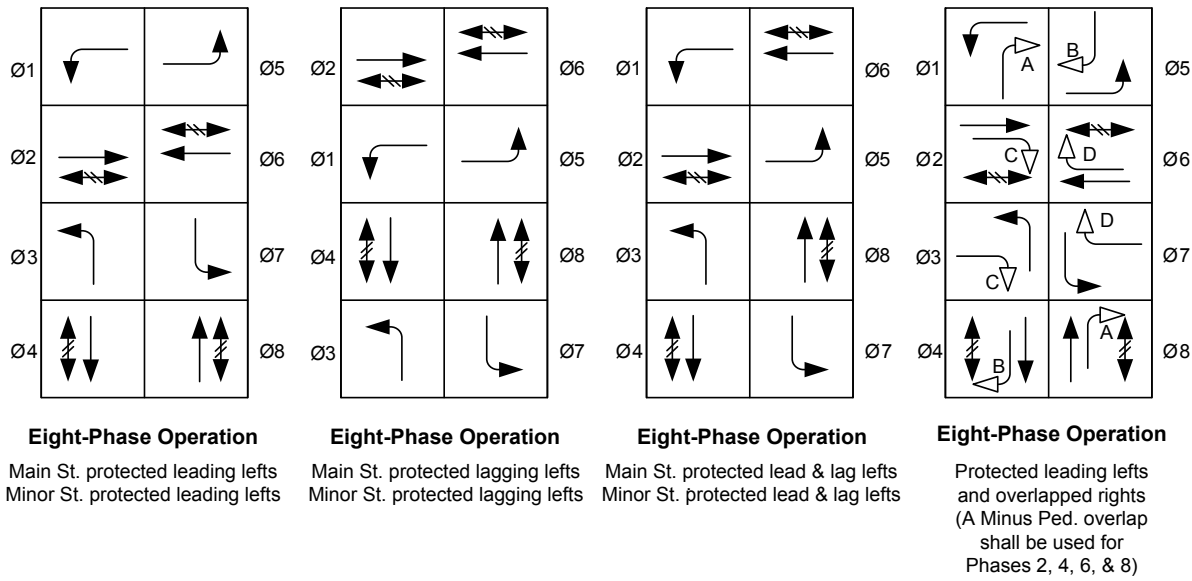
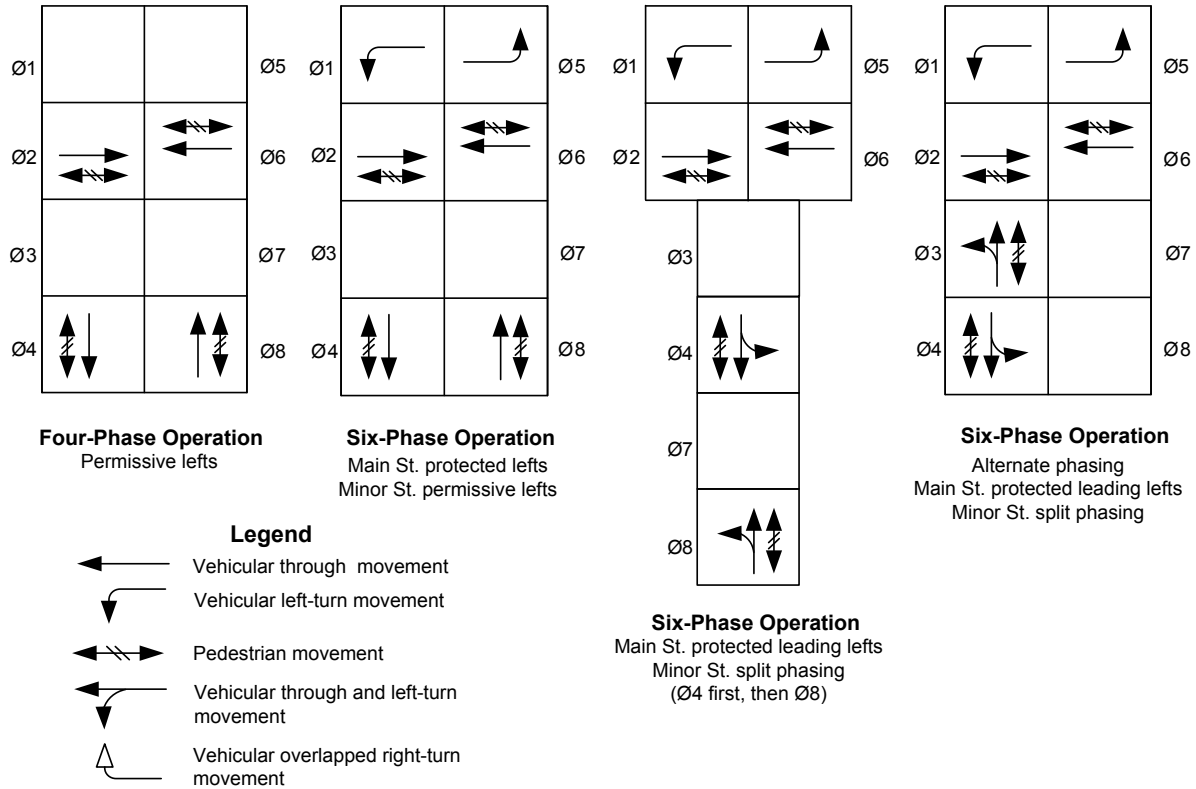

Phase Diagrams: Four-Way Intersections
Exhibit 1330-3

(3) Intersection Design Considerations

Intersection design can have a considerable effect on how a traffic signal will operate, and careful consideration is to be given to this aspect of the design. (See Chapter 1310 for further guidance.)

Left-turning traffic can be better accommodated when the opposing left-turn lanes are directly opposite each other. When a left-turn lane is offset into the path of the approaching through lane, the left-turning driver might assume the approaching vehicles are also in a left-turn lane and fail to yield. To prevent this occurrence, less efficient split phasing may be necessary. (See Chapter 1310 for guidance on opposing left-turn clearance.)

Where a railroad crossing is within 88 feet of a signalized intersection, consider installing turn pockets for the movements leading to the leg of the intersection with the railroad crossing. This greatly improves the efficiency of the signal during railroad preemption when turns are restricted. Also consider providing a left-turn pocket for the minor leg opposing the railroad crossing. This will allow limited service during long periods of railroad preemption.

Consider providing an unrestricted through lane on the major street of a T intersection. This design allows for one traffic movement to flow without restriction. At high-speed intersections where this is used, the through lane is to be separated by a physical barrier or the through movement must also be signalized.

Skewed intersections, because of their geometry, are challenging to signalize and delineate. Where feasible, modify the skew angle to provide more normal approaches and exits. In many cases, the large paved areas for curb return radii at skewed intersections can be reduced when the skew angle is reduced. (See Chapter 1310 for requirements and design options.)

If roadway approaches and driveways are located too close to an intersection, the traffic from these facilities can affect signal operations. Consider eliminating the accesses or restricting them to “right in/right out.” This should be determined early so it can be considered and addressed in the design. (See Chapters 530 and 540 for further guidance.) Consider shifting the location of the advance loops upstream to clear an access point so that vehicles entering from the access point will not affect the loops.

Transit stop and pullout locations can affect signal operation. (See Chapter 1430 for transit stop and pullout designs.) When feasible, locate these stops and pullouts on the far side of the intersection to:

- Minimize overall intersection conflict, particularly the right-turn conflict.
- Minimize impact to the signal operation when buses use preemption to pull out at a traffic signal with transit preemption.
- Provide extra pavement area where U-turn maneuvers are allowed.
- Eliminate sight distance obstructions for drivers attempting to turn right on red.
- Eliminate conflict with right-turn pockets.

Large right-turn curb radii at intersections sometimes have impacts on traffic signal operation. Larger radii allow faster turning speeds and might move the pedestrian entrance point farther away from the intersection area. Pedestrian crossing times are increased because of the longer crossing, thereby reducing the amount of time available for vehicular traffic. (See Chapter 1310 for guidance on determining these radii.)

At intersections with large right-turn radii, consider locating signal standards on raised traffic islands to reduce mast arm lengths. These islands are primarily designed as pedestrian refuge areas. (See Chapter 1510 for pedestrian refuge islands and traffic island designs.) Locating signal standards on islands may decrease the required pedestrian clearance intervals; however, large radii and raised traffic islands may make it difficult for pedestrians to navigate the intersection. Place stop bars so they are out of the path of conflicting left turns. Check the geometric layout by using the turning path templates in Chapter 1310 or a computerized vehicle turning path program to determine whether the proposed layout and phasing can accommodate the design vehicles. Also, check the turning paths of opposing left-turn movements. In many cases, the phase analysis might recommend allowing opposing left turns to run concurrently, but the intersection geometrics are such that this operation cannot occur.

Coordinate with all stakeholders (Maintenance, Signal Operations, Civil Design Engineer, Drainage Engineer, and so on) in the placement of signal equipment to avoid any possible conflicts. Arrange field reviews with the appropriate stakeholders as necessary.

(4) Crosswalks and Pedestrians

When designing pedestrian signals, consider the needs of all pedestrians, including older pedestrians and pedestrians with disabilities who might walk at a significantly slower pace than the average pedestrian. Determine whether there are pedestrian generators in the project vicinity that might attract older people and pedestrians with disabilities, and adjust signal timing accordingly. Include accessible pedestrian pushbuttons and countdown pedestrian displays at all locations and crossings unless a specific crossing is prohibited. Consult with region and city maintenance personnel regarding maintenance requirements for these devices. (See Chapter 1510 for more information on accessible pedestrian routes.)

- Locate pedestrian push buttons in accordance with the most current edition of the *Public Rights-of-Way Accessibility Guidelines* (PROWAG) and the MUTCD.
- Clearly identify which crossing is controlled by the push button.
- Provide a level clear space (maximum 2% slope in any direction, 48 inches minimum by 30 inches minimum) within reach range at each push button for wheelchair users. The level clear space must be connected to the crosswalk it serves by a pedestrian access route.
- Mount push button at a maximum height of 3 feet 6 inches and a maximum horizontal distance of 2 feet from the level clear space surface.

(a) Accessible Pedestrian Signals (APS)

At all locations where pedestrian signals are newly installed, replaced, or significantly modified, the installation of accessible pedestrian signals (APS) and countdown pedestrian displays is required. (Note: Simply moving existing pedestrian push buttons to satellite poles to improve accessibility is not by itself considered a significant modification of the pedestrian signal.) When APS and countdown pedestrian display improvements are made, they shall be made for all locations associated with the system being improved. APS includes audible and vibrotactile indications of the WALK interval. Installation of these devices may

require improvements to existing sidewalks and curb ramps to ensure ADA compliance.

Refer to the MUTCD and the most current edition of the PROWAG for design requirements. Also, consult with HQ Traffic Operations, the HQ Design Office, and region and city maintenance personnel for current equipment specifications and additional design and maintenance requirements.

Crosswalks, whether marked or not, exist at all intersections. If a pedestrian movement will be prohibited at an intersection, provide signing and a physical barrier for this prohibition. Exhibit 1330-5 shows an example of a closed pedestrian crossing. The signing and barriers are positioned on both the near side and far side of the street to be visible to pedestrians. When positioning these signs and barriers for visibility, consider the location of the stop bar where this crossing will be prohibited. Vehicles stopped at the stop bar might obstruct the view of the signing and barrier. There are normally three crosswalks at a “T” intersection and four crosswalks at a “four-leg” intersection. For pedestrian route continuity, the minimum number of crosswalks is two at T intersections and three at four-leg intersections. For Diamond interchanges with heavy left-turn movements from the off-ramp approach, consider deleting the crosswalk on the left side of the off-ramp approach. This will eliminate a conflict between pedestrians and left-turning vehicles from the off-ramp and increase traffic signal efficiency. There are situations where reducing the minimum number of crosswalks mentioned above is needed; however, approval from the region Traffic Engineer is required. Prohibiting a pedestrian movement requires an Engineering Study documenting the reasons for prohibiting the crossing, as well as region Traffic Engineer approval and inclusion in the DDP. Evaluate pedestrian exposure for all alternatives considered.

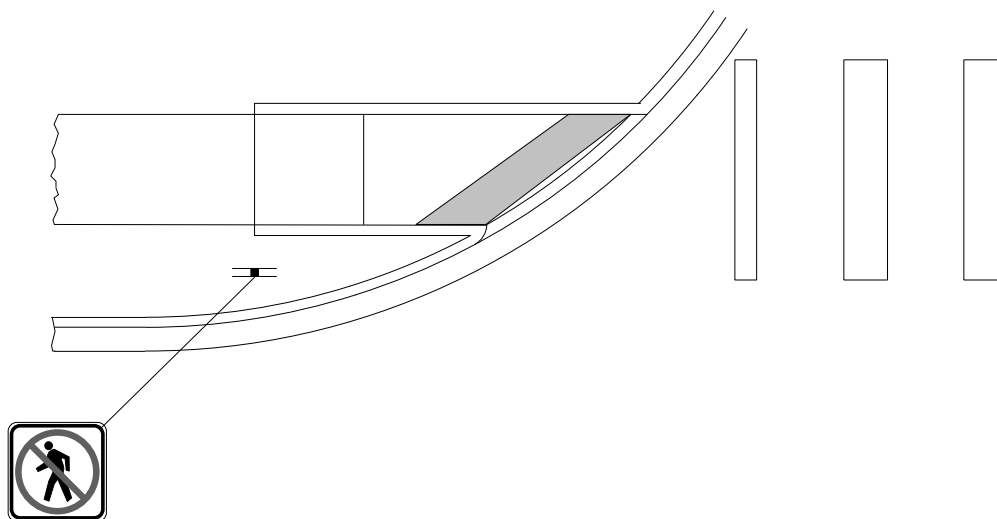

Example of Closed Pedestrian Crossing

Exhibit 1330-5

If a crosswalk is installed across the leg where right-turning or left-turning traffic enters, the vehicle display cannot have a green turn arrow indication during the pedestrian WALK phase. If this cannot be accomplished through a negative ped overlap, provide a separate pedestrian or vehicle turn phase. Use of exclusive pedestrian phases should be avoided because of the negative effect they can have on efficient traffic signal operations.

(5) Control Equipment

Controller assemblies can be Type 170, Type 2070, or National Electrical Manufacturers Association (NEMA) controllers with dual ring, eight vehicle phases, four pedestrian phases, four overlaps, emergency vehicle preemption, railroad preemption, transit preemption, and start and end daylight savings time dates operational capabilities. From a design perspective, identical operation can be obtained from each controller. Specify Type 2070 unless region policy is to use 170 or NEMA controllers. The local controller software can impact the brand and model of the control equipment installed. Contact the region Signal Operations Engineer for software and controller specifications. The designer needs to specify the type of controller and the operating software to be installed. Include documentation of selected control equipment in the Project File.

Intersections within ½ mile of each other on low-speed state highways should be interconnected. Intersections within 1 mile of each other on high-speed state highways should be interconnected. The preferred method for interconnection is fiber optic cable, but other methods such as IP over copper or wireless interconnect may be considered after discussion with the region Signal Operations Engineer and approval by the region Traffic Engineer. Add a construction note in the plans stating to coil additional cable in the adjacent junction box, not the controller cabinet. Consider using a separate vault or junction box for coiling the fiber optic interconnect cable to allow for the large-bend radii. This will save on space in the controller cabinet and also allow additional cable in case the cabinet is hit by an errant vehicle. In situations where it is necessary to coordinate the traffic movements with another agency, it is important that the agencies work together.

Vacant

Exhibit 1330-6a

Vacant

Exhibit 1330-6b

at the 85th percentile speed and position the advance loops at this distance in advance of the stop bar.

- When the posted speed is at or above 35 mph, provide advance detection based on the “decision zone detection design.” When stop bar detection is installed, it should extend from the stop bar to a point 30 to 40 feet in advance of that location. Stop bar detection is required on minor streets. Stop bar detection is usually assigned to detection input “call” channels, and advance detection is usually assigned to detection input “extension/call” channels. Coordinate with the Signal Operations Engineer on detection assignments.

A decision zone is a location along the intersection approach where a motorist is forced to make a decision between two alternatives. As applied to vehicle detection design, this situation can occur when two vehicles are approaching a traffic signal and the signal indication turns yellow. The motorist in each vehicle must decide whether to continue through the intersection or stop prior to the intersection. If the lead vehicle decides to brake and the following vehicle does not, there may be a rear-end collision. Decision zone detection design has been developed to reduce the chances of this occurrence. This design increases the opportunity for a range of vehicles from the 90th percentile speed vehicle to the 10th percentile speed vehicle to either clear the intersection safely or decelerate to a complete stop before reaching the intersection. The method of calculating the decision zone and the required detection loops is shown in Exhibit 1330-7. Include the calculations in the Project File.

A study of the approach speeds at the intersection is necessary to design the decision zone detection. Speed study data is obtained at the approximate location or just upstream of the decision zone. Only the speed of the lead vehicle in each platoon is considered. Speed study data is gathered during off-peak hours in free-flow and favorable weather conditions. It is important that the person conducting the speed study remain inconspicuous so they do not influence drivers to slow down. Normal driving patterns are needed for proper speed studies. Prior speed-study information obtained at this location can be used if it is less than 18 months old and driving conditions have not changed significantly in the area.

When permissive left-turn phasing is installed on the major street with left-turn channelization, include provisions for switching the detector input for future protected left-turn phasing. Assign the detector a left-turn detector number and connect to the appropriate left-turn detector amplifier. Most controller software can do this internally. If the controller being specified cannot do this internally, then specify a jumper connector between that amplifier output and the extension input channel for the adjacent through movement detector. The jumper is removed when the left-turn phasing is changed to protected left-turn phasing in the future. Check with the Signal Operations Engineer to see whether this is available with the software being used.

Where:

V_{90} = 90th percentile speed in ft per second

V_{10} = 10th percentile speed in ft per second

UDZ₉₀ = Upstream end of decision zone for 90th percentile speed

DDZ₁₀ = Downstream end of decision zone for 10th percentile speed

LC₁ = V_{10} travel time to downstream DDZ₁₀

LC₂ = V_{10} travel time from 1st loop to 2nd loop

LC₃ = V_{10} travel time from 3rd loop to DDZ₁₀

G = Grade of roadway in decimal form
(include + or -) Example: -4% = -0.04

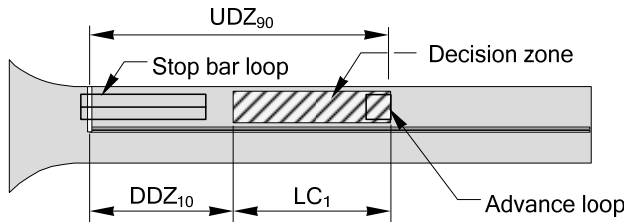

Single Advance Loop Design

Use when LC₁ is less than or equal to 3 seconds.

Use with grades less than +/- 4%:

$$UDZ_{90} = \frac{(V_{90})^2}{16} + V_{90}$$

$$DDZ_{10} = \frac{(V_{10})^2}{40} + V_{10}$$

$$LC_1 = \frac{UDZ_{90} - DDZ_{10}}{V_{10}}$$

Use with grades +/- 4% or steeper:

$$UDZ_{90} = \frac{(V_{90})^2}{2(8 + 32.2G)} + V_{90}$$

$$DDZ_{10} = \frac{(V_{10})^2}{2(20 + 32.2G)} + V_{10}$$

$$LC_1 = \frac{UDZ_{90} - DDZ_{10}}{V_{10}}$$

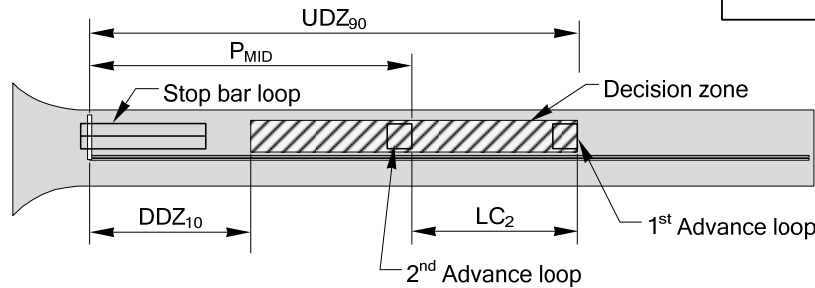

Double Advance Loop Design

Use when LC₂ is less than or equal to 3 seconds.

$$LC_2 = \frac{UDZ_{90} - P_{MID}}{V_{10}}$$

$$P_{MID} = \frac{UDZ_{90} + DDZ_{10}}{2}$$

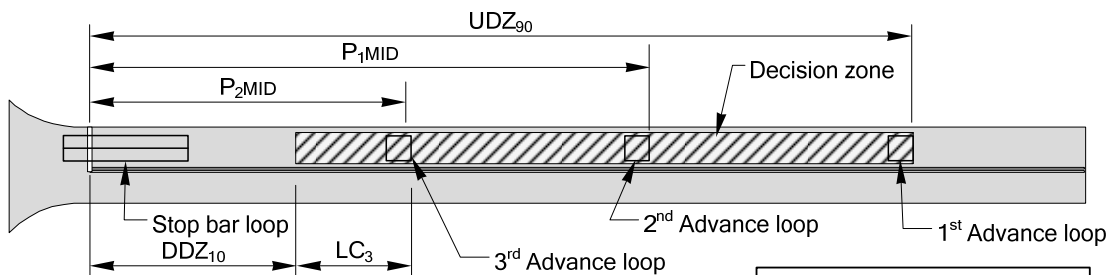

Triple Advance Loop Design

Use when LC₃ is less than or equal to 3 seconds.

$$LC_3 = \frac{UDZ_{90} - DDZ_{10}}{3V_{10}}$$

$$P_{1MID} = \frac{[2(UDZ_{90}) + DDZ_{10}]}{3}$$

$$P_{2MID} = \frac{[UDZ_{90} + 2(DDZ_{10})]}{3}$$

Decision Zone Loop Placement
Exhibit 1330-7

In most cases, electromagnetic induction loops provide the most reliable method of vehicle detection. Details of the construction of these loops are shown in the *Standard Plans*. Video detection should be used only for temporary or portable traffic signals or locations with undesirable pavement conditions unless approved for other usage by the region Traffic Engineer. Other types of vehicle detection, such as in-pavement wireless magnetometers, may be used with approval from the region Traffic Engineer. Consider video detection systems for projects at the following locations: projects that have extensive stage construction with numerous alignment changes; on a private leg of an intersection where an easement is not available; and on existing bridge deck where loops or other types of in-pavement detection cannot be placed into the bridge deck.

Video detection functions best when the detectors (cameras) are positioned high above the intersection. In this position, the maximum effective detection area can be about ten times the mounting height in advance of the camera. (Contact the appropriate video detection equipment manufacturer for specific installation requirements.) When video detection is proposed, installation of the cameras on the luminaire mast arms can often provide good detection coverage. However, high wind can adversely affect the video equipment by inducing vibration in the luminaire mast arms. Also, areas that experience frequent high winds are not always suitable for video detection. Snow, fog, and rain can also adversely affect the operation of video detection equipment.

Provide temporary decision zone detection on projects where the decision zone detection will be disconnected for more than 48 hours, unless the designer concurs with the Signal Operations Engineer that the temporary detection is not necessary. The designer needs to find out whether there is a speed reduction during construction and place the temporary decision zone detection accordingly.

For loop numbering, see Exhibit 1330-8.

(7) Preemption Systems

(a) Emergency Vehicle Preemption

Emergency vehicle preemption is required for all traffic signals unless approved otherwise by the region Traffic Engineer. WSDOT is responsible for the preemption equipment that is permanently installed at the intersection for new construction or rebuild projects. The emergency service agency is responsible for preemption emitters in all cases. If the emergency agency requests additional preemption equipment at an existing signal, that agency is responsible for all installation costs for equipment installed permanently at the intersection. The standard emergency vehicle system is optically activated to be compatible with all area emergency service agency emitters. Approval by the State Traffic Engineer is required for the installation of any other type of emergency vehicle preemption system. Include emergency service vehicle preemption system documentation in the Project File.

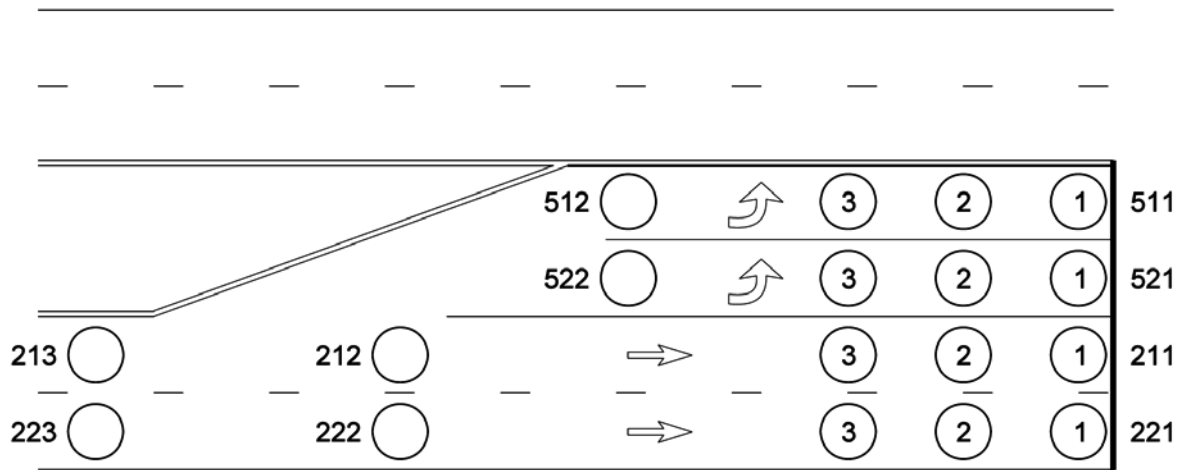

Round Loop Layout Example

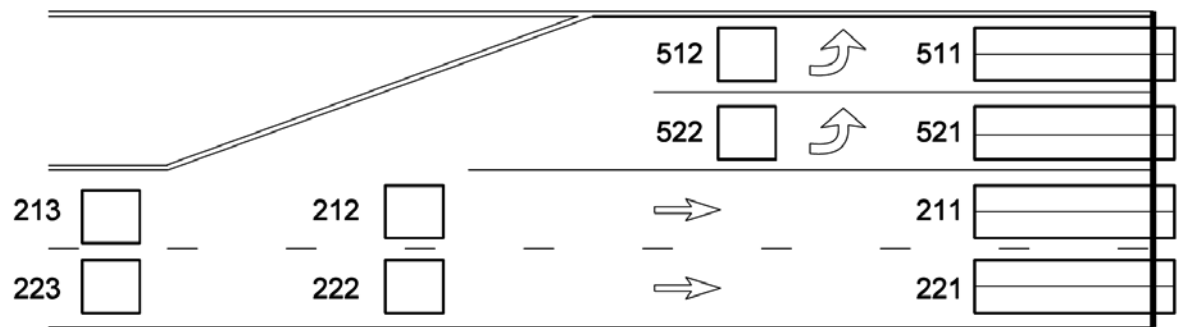

Square Loop Layout Example

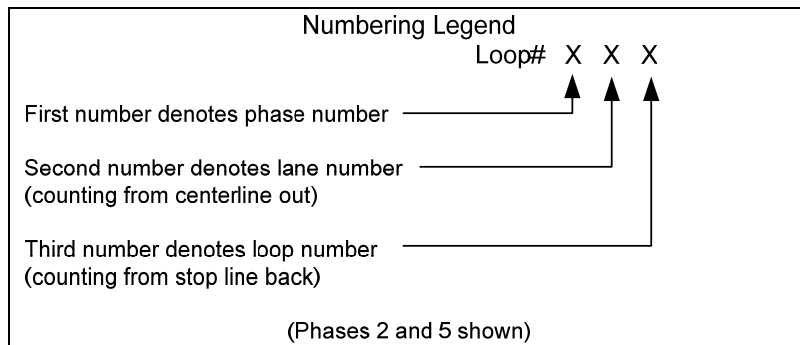

Loop Numbering Layout
Exhibit 1330-8

- The minimum size conduit for installations under a roadway at all other locations is 2 inches.

A 2-inch spare conduit is to be installed for all conduit crossings outside the core of the intersection. A 3-inch spare conduit is to be installed for all conduit crossings around the intersection perimeter. At least one 3-inch spare conduit is to be installed from the controller to the adjacent junction box to provide for future capacity. Size all conduits to provide 26% maximum conductor fill for new signal installations. A 40% fill area can be used when installing conductors in existing conduits. (See Exhibit 1330-13 for conduit and signal conductor sizes.)

Conduit Sizing Table			
Trade Size	Inside Diam. (inches)	Maximum Fill (inch ²)	
		26%	40%
1/2"	0.632	0.08	0.13
3/4"	0.836	0.14	0.22
1"	1.063	0.23	0.35
1 1/4"	1.394	0.40	0.61
1 1/2"	1.624	0.54	0.83
2"	2.083	0.89	1.36
2 1/2"	2.489	1.27	1.95
3"	3.09	1.95	3.00
3 1/2"	3.57	2.60	4.00
4"	4.05	3.35	5.15

Conductor Size Table			
Size (AWG)	Area (inch ²)	Size (AWG)	Area (inch ²)
# 14 USE	0.021	2cs (# 14)	0.090
# 12 USE	0.026	3cs (# 20)	0.070
# 10 USE	0.033	4cs (# 18)	0.060
# 8 USE	0.056	5c (# 14)	0.140
# 6 USE	0.073	7c (# 14)	0.170
# 4 USE	0.097	10c (# 14)	0.290
# 3 USE	0.113	6pcc (# 19)	0.320
# 2 USE	0.133		

Conduit and Conductor Sizes

Exhibit 1330-13

(d) **Electrical Service and Other Components**

Refer to Chapter 1040 for electrical service types, overcurrent protection, and descriptions and requirements for other components.

(e) **Roadway Conduit Crossings**

Minimize roadway crossings whenever possible; usually only three crossings are needed for a four-leg intersection and only two roadway crossings are needed for a T intersection. In most cases, the conduit should cross both the main line and side street from the corner where the controller is located. Directional boring is the method of choice when crossing the state route (main line). One main line crossing is usually sufficient; open cut trenching is acceptable on minor approaches. Open cut trenching to install conduits is allowed on existing roadways where substantial obstacles under the roadway will be encountered or where there is insufficient room for jacking or boring pits at the edges of the roadway. Open cut trenching is not permitted across limited access roadways unless the entire pavement surface is being replaced. Do not use sign or signal bridges for roadway crossings.

(12) Signal Design and Operation Near Railroad Crossings

If railroad tracks are within 500 feet of a signalized intersection, then a Railroad Crossing Evaluation Team is formed to determine the need (if any) for railroad preemption, interconnection, simultaneous preemption, advanced preemption, and so on. The Railroad Crossing Evaluation Team should consist of region and HQ Signal Design Engineers, region and HQ Signal Operations Engineers, HQ Railroad Liaison, region Utilities Engineer, region Traffic Design Engineer, region Maintenance Superintendent, and the affected railroad representative.

The Railroad Crossing Evaluation Team will determine what design considerations are needed at all signalized intersections near railroad crossings. A memo with each team member's concurrence with the PS&E documents is required for the DDP and is to be preserved as noted in 1330.07, Documentation. If railroad tracks are located within ¼ mile and are in excess of 500 feet from a signalized intersection, the same procedure will apply unless the region can demonstrate that 95% maximum queue lengths will not extend to within an area 200 feet from the tracks. Such demonstration is to be documented in the DDP and approved by the Railroad Crossing Evaluation Team.

The Railroad Crossing Evaluation Team has final review and approval authority for all PS&E documents for signal design and operation at all signalized intersections near railroad crossings.

Railroad preemption and interconnection are recommended when any of the following conditions occurs:

- The distance from the stop bar to the nearest rail is less than or equal to 200 feet.
- The 95% maximum queue lengths from the intersection stop bar are projected to cross the tracks. (Use a queue arrival/departure study or a traffic analysis "micro-simulation model" to determine 95% maximum queue lengths.)

- 1360.01 General
- 1360.02 References
- 1360.03 Definitions
- 1360.04 Interchange Design
- 1360.05 Ramps
- 1360.06 Interchange Connections
- 1360.07 Ramp Terminal Intersections at Crossroads
- 1360.08 Interchanges on Two-Lane Highways
- 1360.09 Interchange Plans for Approval
- 1360.10 Documentation

1360.01 General

The primary purpose of an interchange is to reduce conflicts caused by vehicle crossings and minimize conflicting left-turn movements. Provide interchanges on all Interstate highways and freeways, and at other locations where traffic cannot be controlled efficiently by intersections at grade.

For additional information, see the following chapters:

Chapter	Subject
520	Access control
530	Limited access
550	Interchange justification report
1230	Ramp sections
1240	Turning widths
1250	Superelevation
1310	Intersections
1410	HOV lanes
1420	HOV direct access connections

1360.02 References

(1) Design Guidance

Manual on Uniform Traffic Control Devices for Streets and Highways, USDOT, FHWA; as adopted and modified by Chapter 468-95 WAC “Manual on uniform traffic control devices for streets and highways” (MUTCD)

Plans Preparation Manual, M 22-31, WSDOT

Standard Plans for Road, Bridge, and Municipal Construction (Standard Plans), M 21-01, WSDOT

Standard Specifications for Road, Bridge, and Municipal Construction (Standard Specifications), M 41-10, WSDOT

(2) Supporting Information

A Policy on Geometric Design of Highways and Streets (Green Book), AASHTO, 2004

A Policy on Design Standards – Interstate System, AASHTO, 2005

Highway Capacity Manual (Special Report 209), Transportation Research Board

Procedure for Analysis and Design of Weaving Sections: A User's Guide, Jack E. Leisch, October 1985

1360.03 Definitions

Note: For definitions of *frontage road*, *design speed*, *divided multilane*, *expressway*, *highway*, *outer separation*, *roadway*, *rural design area*, *suburban area*, *traveled way*, *undivided multilane*, and *urban design area*, see Chapter 1140; for *basic number of lanes*, see Chapter 1210; for *lane*, *median*, and *shoulder*, see Chapter 1230; for *decision sight distance*, *sight distance*, and *stopping sight distance*, see Chapter 1260; for *auxiliary lane*, see Chapter 1270; and for *intersection at grade*, see Chapter 1310.

collector-distributor road (C-D road) A parallel roadway designed to remove weaving from the main line and reduce the number of main line entrances and exits.

gore The area downstream from the intersection of the shoulders of the main line and exit ramp. Although generally referring to the area between a main line and an exit ramp, the term may also be used to refer to the area between a main line and an entrance ramp.

gore nose At an exit ramp, the point at the end of the gore area where the paved shoulders of the main line and the ramp separate (see Exhibits 1360-11a and 11b) or the beginning of traffic barrier, not including any impact attenuator. Also, the similar point at an entrance ramp.

Interstate System A network of routes selected by the state and the Federal Highway Administration (FHWA) under terms of the federal-aid acts as being the most important to the development of a national transportation system. The Interstate System is part of the principal arterial system.

interchange A system of interconnecting roadways, in conjunction with one or more grade separations, providing for the exchange of traffic between two or more intersecting highways or roadways.

painted nose The point where the main line and ramp lanes separate.

physical nose The point, upstream of the gore, with a separation between the roadways of 16 to 22 feet (see Exhibits 1360-11a and 11b).

ramp A short roadway connecting a main lane of a freeway with another facility.

ramp connection The pavement at the end of a ramp that connects it to a main lane of a freeway.

ramp meter A traffic signal at a freeway entrance ramp that allows a measured or regulated amount of traffic to enter the freeway.

ramp terminal An intersection at the end of a ramp.

weaving section A length of highway over which one-way traffic streams cross by merging and diverging maneuvers.

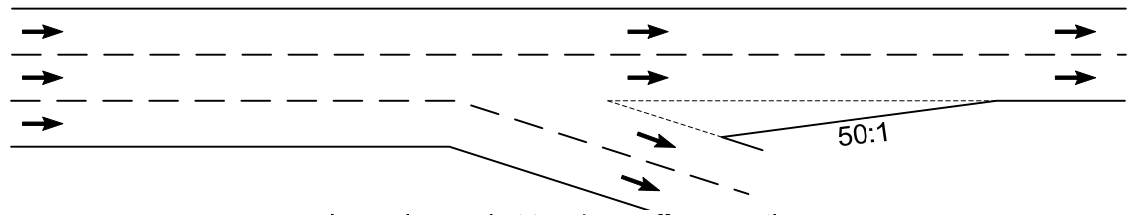

Lane dropped at two-lane off-connection

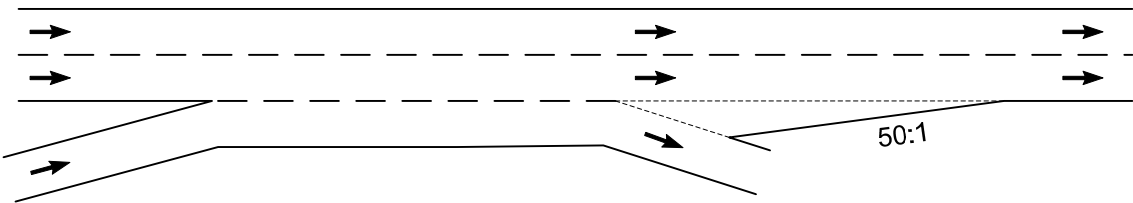

Lane between closely spaced ramps
dropped at single-lane off-connection
(lane imbalance for weaving)

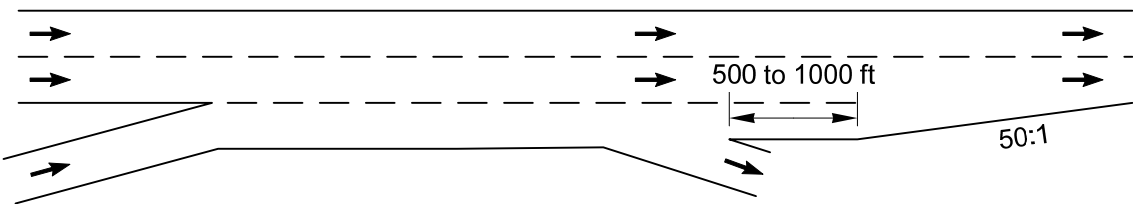

Lane between closely spaced ramps
dropped at single-lane off-connection
(lane balance for weaving)

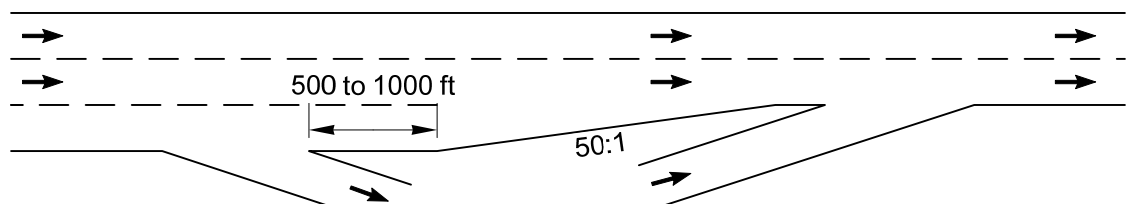

Lane dropped within intersection

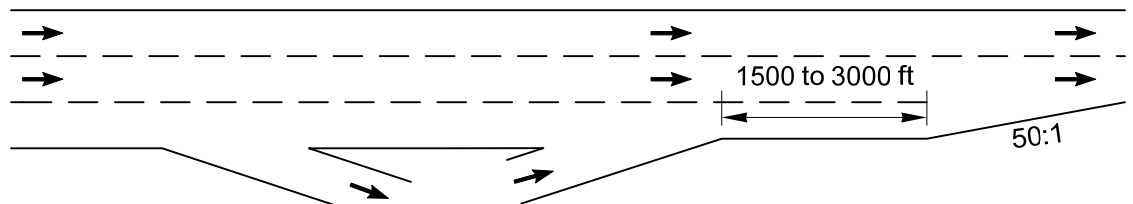

Lane dropped between interchanges

Main Line Lane Reduction Alternatives
Exhibit 1360-8

(4) On-Connections

On-connections are the paved areas at the end of on-ramps that connect them to the main lane of a freeway. They have two parts: an acceleration lane and a taper. The acceleration lane allows entering traffic to accelerate to the freeway speed and evaluate gaps in the freeway traffic. The taper is for the entering vehicle to maneuver into the through lane.

On-connections are either tapered or parallel. The tapered on-connection provides direct entry at a flat angle, reducing the steering control needed. The parallel on-connection adds a lane adjacent to the through lane for acceleration with a taper at the end. Vehicles merge with the through traffic with a reverse curve maneuver similar to a lane change. While less steering control is needed for the taper, the parallel is narrower at the end of the ramp and has a shorter taper at the end of the acceleration lane.

(a) Acceleration Lane

Provide the minimum acceleration lane length, given in Exhibit 1360-9, for each ramp design speed on all on-ramps. When the average grade of the acceleration lane is 3% or greater, multiply the distance from the Minimum Acceleration Lane Length table by the factor from the Adjustment Factor for Grades table.

For existing ramps that do not have significant collisions in the area of the connection with the freeway, the freeway posted speed may be used to calculate the acceleration lane length for Preservation projects. If corrective action is indicated, use the freeway design speed to determine the length of the acceleration lane.

Justify as a design exception the existing ramps that will remain in place and that have an acceleration lane length less than the design speed. Also, document in the Project File the ramp location, the acceleration length available, and the collision analysis that shows there are not significant collisions in the area of the connection.

The acceleration lane is measured from the last point designed at each ramp design speed (usually the PT of the last curve for each design speed) to the last point with a ramp width of 12 feet. Curves designed at higher design speeds may be included as part of the acceleration lane length.

(b) Gap Acceptance

For parallel on-connections, provide the minimum gap acceptance length (L_g) to allow entering motorists to evaluate gaps in the freeway traffic and position their vehicles to use the gap. The length is measured beginning at the point that the left edge of traveled way for the ramp intersects the right edge of traveled way of the main line to the ending of the acceleration lane (see Exhibits 1360-13b and 13c). The gap acceptance length and the acceleration length overlap, with the ending point controlled by the longer of the two.

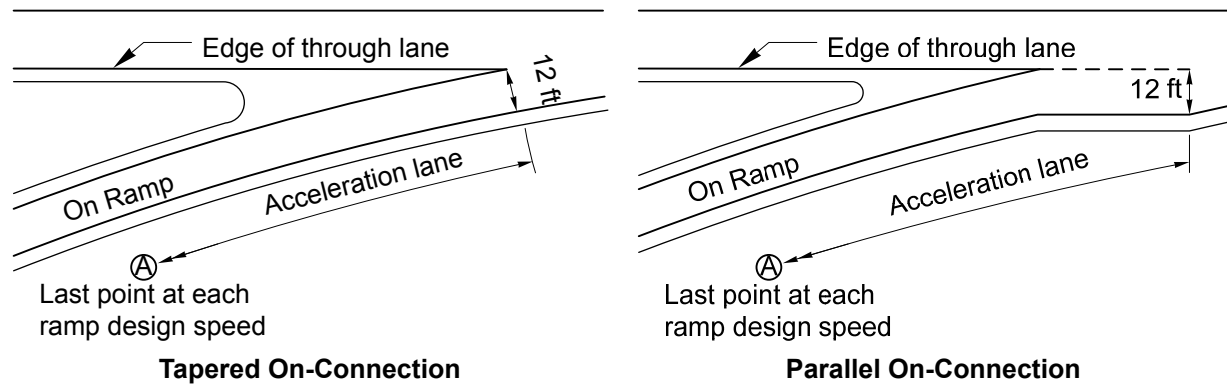

Highway Design Speed (mph)	Ramp Design Speed (mph)										
	0	15	20	25	30	35	40	45	50	60	70
30	180	140									
35	280	220	160								
40	360	300	270	210	120						
45	560	490	440	380	280	160					
50	720	660	610	550	450	350	130				
55	960	900	810	780	670	550	320	150			
60	1200	1140	1100	1020	910	800	550	420	180		
65	1410	1350	1310	1220	1120	1000	770	600	370		
70	1620	1560	1520	1420	1350	1230	1000	820	580	210	
80	2000	1950	1890	1830	1730	1610	1380	1200	970	590	210

Minimum Acceleration Lane Length (ft)

Highway Design Speed (mph)	Grade	Upgrade				Downgrade
		Ramp Design Speed				All Ramp Design Speeds
		20	30	40	50	
40	3% to less than 5%	1.3	1.3			0.70
45		1.3	1.35			0.675
50		1.3	1.4	1.4		0.65
55		1.35	1.45	1.45		0.625
60		1.4	1.5	1.5	1.6	0.60
70		1.5	1.6	1.7	1.8	0.60
40	5% or more	1.5	1.5			0.60
45		1.5	1.6			0.575
50		1.5	1.7	1.9		0.55
55		1.6	1.8	2.05		0.525
60		1.7	1.9	2.2	2.5	0.50
70		2.0	2.2	2.6	3.0	0.50

Adjustment Factors for Grades Greater Than 3%

Acceleration Lane Length

Exhibit 1360-9

(c) **Single-Lane On-Connections**

Single-lane on-connections may be either tapered or parallel. The tapered is desirable; however, the parallel may be used with justification. Design single-lane tapered on-connections as shown in Exhibit 1360-13a and single-lane parallel on-connections as shown in Exhibit 1360-13b.

(d) **Two-Lane On-Connections**

For two-lane on-connections, the parallel is desirable. Design two-lane parallel on-connections as shown in Exhibit 1360-13c. A capacity analysis will normally be the basis for determining whether a freeway lane or an auxiliary lane is to be provided.

Justify the use of a two-lane tapered on-connection. Design two-lane tapered on-connections in accordance with Exhibit 1360-13d.

(5) Off-Connections

Off-connections are the paved areas at the beginning of an off-ramp, connecting it to a main lane of a freeway. They have two parts: a taper for maneuvering out of the through traffic and a deceleration lane to slow to the speed of the first curve on the ramp. Deceleration is not assumed to take place in the taper.

Off-connections are either tapered or parallel. The tapered is desirable because it fits the normal path for most drivers. When a parallel connection is used, drivers tend to drive directly for the ramp and not use the parallel lane. However, when a ramp is on the outside of a curve, the parallel off-connection is desirable. An advantage of the parallel connection is that it is narrower at the beginning of the ramp.

(a) **Deceleration Lane**

Provide the minimum deceleration lane length given in Exhibit 1360-10 for each design speed for all off-ramps. Also, provide deceleration lane length to the end of the anticipated queue at the ramp terminal. When the average grade of the deceleration lane is 3% or greater, multiply the distance from the Minimum Deceleration Lane Length table by the factor from the Adjustment Factor for Grades table.

For existing ramps that do not have significant collisions in the area of the connection with the freeway, the freeway posted speed may be used to calculate the deceleration lane length for Preservation projects. If corrective action is indicated, use the freeway design speed to determine the length of the deceleration lane.

Justify as a design exception the existing ramps that will remain in place and that have a deceleration lane length less than the design speed. Also, document in the Project File the ramp location, the deceleration length available, and the collision analysis that shows there are not significant collisions in the area of the connection.

The deceleration lane is measured from the point where the taper reaches a width of 12 feet to the first point designed at each ramp design speed (usually the PC of the first curve for each design speed). Curves designed at higher design speeds may be included as part of the deceleration lane length.

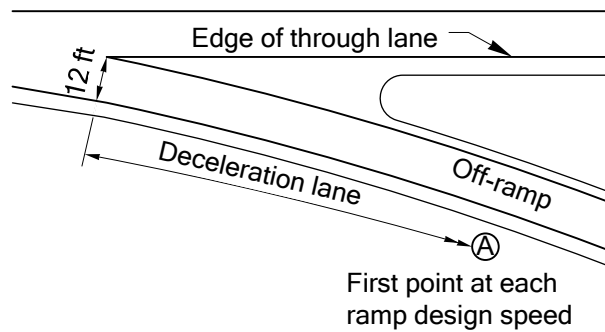

Tapered Off-Connection

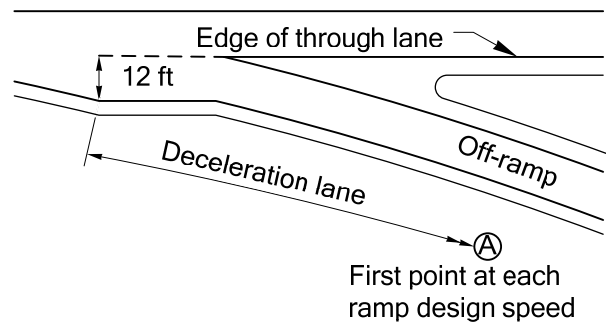

Parallel Off-Connection

Highway Design Speed (mph)	Ramp Design Speed (mph)										
	0	15	20	25	30	35	40	45	50	60	70
30	235	200	170	140							
35	280	250	210	185	150						
40	320	295	265	235	185	155					
45	385	350	325	295	250	220	155				
50	435	405	385	355	315	285	225	175			
55	480	455	440	410	380	350	285	235	180		
60	530	500	480	460	430	405	350	300	240		
65	570	540	520	500	470	440	390	340	280	185	
70	615	590	570	550	520	490	440	390	340	240	
80	735	710	690	670	640	610	555	510	465	360	265

Minimum Deceleration Lane Length (ft)

Grade	Upgrade	Downgrade
3% to less than 5%	0.9	1.2
5% or more	0.8	1.35

Adjustment Factors for Grades Greater Than 3%

Deceleration Lane Length
Exhibit 1360-10

(b) Gores

Gores (see Exhibits 1360-11a and 11b) are decision points. Design them to be clearly seen and understood by approaching drivers. In a series of interchanges along a freeway, it is desirable that the gores be uniform in size, shape, and appearance.

The paved area between the physical nose and the gore nose is the reserve area. It is reserved for the installation of an impact attenuator. The minimum length of the reserve area is controlled by the design speed of the main line (see Exhibits 1360-11a and 11b).

In addition to striping, raised pavement marker rumble strips may be placed for additional warning and delineation at gores. (See the *Standard Plans* for striping and rumble strip details.)

Keep the unpaved area beyond the gore nose as free of obstructions as possible to provide a clear recovery area. Grade this unpaved area as nearly level with the roadways as possible. Avoid placing obstructions such as heavy sign supports, luminaire poles, and structure supports in the gore area.

When an obstruction is placed in a gore area, provide an impact attenuator (see Chapter 1620) and barrier (see Chapter 1610). Place the beginning of the attenuator as far back in the reserve area as possible, desirably after the gore nose.

(c) Single-Lane Off-Connections

For single-lane off-connections, the tapered is desirable. Use the design shown in Exhibit 1360-14a for tapered single-lane off-connections. Justify the use of a parallel single-lane off-connection, as shown in Exhibit 1360-14b.

(d) Single-Lane Off-Connection With One Lane Reduction

The single-lane off-connection with one lane reduction, shown in Exhibit 1360-14c, is used when the conditions from lane balance for a single-lane exit, one-lane reduction, are met.

(e) Tapered Two-Lane Off-Connection

The tapered two-lane off-connection design, shown in Exhibit 1360-14d, is desirable where the number of freeway lanes is reduced or where high-volume traffic operations will be improved by the provision of a parallel auxiliary lane and the number of freeway lanes is unchanged.

(f) Parallel Two-Lane Off-Connection

The parallel two-lane off-connection, shown in Exhibit 1360-14e, allows less operational flexibility than the taper, requiring more lane changes. Justify the use of a parallel two-lane off-connection.

1360.08 Interchanges on Two-Lane Highways

Occasionally, the first stage of a conventional interchange will be built with only one direction of the main roadway and operated as a two-lane two-way roadway until the ultimate roadway is constructed.

The design of interchanges on two-lane two-way highways may vary considerably from traditional concepts due to the following conditions:

- The potential for cross-centerline collisions due to merge conflicts or motorist confusion.
- The potential for wrong-way or U-turn movements.
- Future construction considerations.
- Traffic type and volume.
- The proximity to multilane highway sections that might influence a driver's impression that these roads are also multilane.

Provide the deceleration taper for all interchange exit ramps on two-lane highways. Design the entering connection with either the normal acceleration taper or a "button hook" configuration with a stop condition before entering the main line. Consider the following items:

- Design the stop condition connection in accordance with a tee (T) intersection as shown in Chapter 1310. Use this type of connection when an acceleration lane is not possible. Provide decision sight distance as described in Chapter 1260.
- Since designs may vary from project to project, analyze each project for the most efficient signing placement, such as one-way, two-way, no passing, do not enter, directional arrows, guideposts, and traffic buttons.
- Prohibit passing through the interchange area on two-lane highways by means of signing, pavement marking, or a combination of both. The desirable treatment is a 4-foot median island, highlighted with raised pavement markers and diagonal stripes. When using a 4-foot median system, extend the island 500 feet beyond any merging ramp traffic acceleration taper. The width for the median can be provided by reducing each shoulder 2 feet through the interchange (see Exhibit 1360-17).
- Include signing and pavement markings to inform both the entering and through motorists of the two-lane two-way characteristic of the main line.
- Use as much of the ultimate roadway as possible. Where this is not possible, leave the area for future lanes and roadway ungraded.
- Design and construct temporary ramps as if they were permanent unless second-stage construction is planned to rapidly follow the first stage. Design the connection to meet the needs of the traffic.

1360.09 Interchange Plans for Approval

Exhibit 1360-18 is a sample showing the general format and data for interchange design plans.

Compass directions (W-S Ramp) or crossroad names (E-C Street) may be used for ramp designations.

Include the following, as applicable:

- Classes of highway and design speeds for main line and crossroads (see Chapter 1140).
- Curve data on main line, ramps, and crossroads.
- Numbers of lanes and widths of lanes and shoulders on main line, crossroads, and ramps.
- Superelevation diagrams for the main line, the crossroad, and all ramps; these may be submitted on separate sheets.
- Channelization (see Chapter 1310).
- Stationing of ramp connections and channelization.
- Proposed right of way and access control treatment (see Chapters 510, 520, and 530).
- Delineation of all crossroads, existing and realigned (see Chapter 1310).
- Traffic data for the proposed design; include all movements.
- For HOV direct access connections on the left, include the statement that the connection will be used solely by HOVs or will be closed.

Prepare a preliminary contour grading plan for each completed interchange. Show the desired contours of the completed interchange, including details of basic land formation, slopes, graded areas, or other special features. Coordinate the contour grading with the drainage design and the roadside development plan.

1360.10 Documentation

For the list of documents required to be preserved in the Design Documentation Package and the Project File, see the Design Documentation Checklist:

☞ www.wsdot.wa.gov/design/projectdev/

- 1370.01 General
- 1370.02 Analysis
- 1370.03 Design
- 1370.04 Plan Updates and Approvals
- 1370.05 Documentation

1370.01 General

This chapter provides guidance for locating and designing median crossovers.

Median crossovers are provided at locations on divided highways for crossing by maintenance, traffic service, emergency, and law enforcement vehicles. The use of all median crossovers is restricted to these users.

Crossovers may be provided:

- Where main line safety will not be compromised by providing a crossover.
- Where access through interchanges or intersections is not practical.
- As part of region maintenance operations.
- As necessary for law enforcement and emergency services functions.

For information about median openings to provide turning movements for public access to both sides of the roadway, see Chapter 1310, Intersections at Grade.

1370.02 Analysis

A list of existing median crossovers is available from the Headquarters (HQ) Access and Hearings Section. The Statewide Master Plan for Median Crossovers website is:
🔗 www.wsdot.wa.gov/design/accessandhearings/tracking.htm

The general categories of vehicles recognized as legitimate users of median crossovers are law enforcement, emergency services, traffic incident response, and maintenance vehicles.

In urban areas with a high-occupancy vehicle (HOV) lane adjacent to the median, crossovers may be considered for law enforcement (see Chapter 1410).

In areas where there are 3 or more miles between access points, providing an unobtrusive crossover can improve emergency services or improve efficiency for traffic services and maintenance forces.

Maintenance crossovers may be needed at one or both ends of an interchange for the purpose of winter maintenance operations and at other locations to facilitate maintenance operations. In general:

- Existing crossovers may remain at their current locations.

- New crossovers should not be located closer than 1,500 feet to the end of a ramp taper or to any structure. This distance may be decreased to improve winter maintenance efficiency based on an operational analysis. Include an operational analysis in the Design Documentation Package (DDP).
- Crossovers should be located only where stopping sight distance is provided and preferably should not be located on superelevated curves.

1370.03 Design

Use the following design criteria for all median crossovers, taking into consideration the intended vehicle usage. Some of these criteria may not apply to crossovers intended primarily for law enforcement.

- Adequate median width at the crossover location is required to allow the design vehicle to complete a U-turn maneuver without backing. Use of the shoulder area is allowed for the execution of the U-turn maneuver. Typical design vehicles for this determination are a passenger car and a single-unit truck.
- When median barrier is placed in the vicinity of a median crossover, position the barrier to minimize the potential for errant vehicles to cross through the median. (See the *Standard Plans* for typical barrier layout.)
- Consider the types of vehicles using the median crossover.
- The minimum recommended throat width is 30 feet.
- Use grades and radii that are suitable for all authorized user vehicles (see Chapter 1340).
- In most cases, 10-foot inside paved shoulders are adequate for deceleration and acceleration lanes. Consider full 10-foot shoulders for a distance of 450 feet upstream of the crossover area to accommodate deceleration, and extend downstream of the crossover area for a distance of 600 feet to allow acceleration prior to entering the travel lane. In cases where the median width is narrower than the design vehicle turning path, widening shoulders may not provide a benefit. Document decisions to provide inside shoulders of less than 10 feet.
- Provide adequate stopping sight distance for vehicles approaching the crossover area. This is due to the unexpected maneuvers associated with these inside access points and the higher operating speeds commonly experienced in the inside travel lanes (see Chapter 1260).
- Provide adequate intersection sight distance at crossover locations where authorized user vehicles must encroach on the travel lanes (see Chapter 1310).
- For the crossing, use sideslopes no steeper than 10H:1V. Grade for a relatively flat and gently contoured appearance that is inconspicuous to the public.
- Consider impacts to existing drainage.
- Do not use curbs or pavement markings.
- Flexible guideposts may be provided for night reference, as shown in the *Standard Plans*.

- Consider the terrain and locate the crossover to minimize visibility to the public.
- Use vegetation to minimize the visibility of the crossover. Low vegetation with a 3-foot year-round maximum height is recommended for this purpose (see Chapter 900).
- In locations where vegetation cannot be used to minimize visibility by the traveling public, and there is a high incidence of unauthorized use, use appropriate signing such as “No U-Turns” to discourage unauthorized use.
- A stabilized all-weather surface is required. Paving of crossings is determined on a case-by-case basis.

1370.04 Plan Updates and Approvals

All approved crossover locations will be designated on the Statewide Master Plan for Median Crossovers. Contact the HQ Access and Hearings Section for the following:

- Proposed new crossings
- Relocation of previously approved crossings
- Removal of crossings that are no longer required

Plan updates and approvals involve coordination between the Assistant Regional Administrator for Operations or Project Development, the Washington State Patrol (WSP), the HQ Access and Hearings Section, the appropriate Assistant State Design Engineer (ASDE), and the Federal Highway Administration (FHA) Area Engineer (or their designees).

Once locations are identified, the region will send a package to the HQ Access and Hearings Section, which should include: a strip map showing MP locations of, and spacing between, existing and/or planned crossovers and interchanges; a justification for the crossover(s); a copy of any requests for crossovers from the WSP, emergency services, or maintenance; and a red and green marked-up plan sheet showing locations. Approval will be given by the ASDE. Construction may not proceed prior to approval.

After notification of approval, the HQ Right of Way Plans Section sends the region a reproducible revised right of way or limited access plan that includes the approved crossover location.

1370.05 Documentation

For the list of documents required to be preserved in the Design Documentation Package and the Project File, see the Design Documentation Checklist:

☞ www.wsdot.wa.gov/design/projectdev/

1510.01	General	1510.10	Crosswalks
1510.02	References	1510.11	Raised Medians/Traffic Islands
1510.03	Definitions	1510.12	Pedestrian Push Buttons at Signals
1510.04	Policy	1510.13	At-Grade Railroad Crossings
1510.05	ADA Requirements by Project Type	1510.14	Pedestrian Grade Separations (Structures)
1510.06	Pedestrian Circulation Paths	1510.15	Other Pedestrian Facilities
1510.07	Pedestrian Access Routes	1510.16	Illumination and Signing
1510.08	Sidewalks	1510.17	Work Zone Pedestrian Accommodation
1510.09	Curb Ramps	1510.18	Documentation

1510.01 General

Pedestrian travel is a vital transportation mode. It is used at some point by nearly everyone and is a critical link to everyday life for many. Designers must be aware of the various physical needs and abilities of pedestrians in order to ensure facilities provide universal access.

Section 504 of the Rehabilitation Act and the Americans with Disabilities Act of 1990 (ADA) require pedestrian facilities to be designed and constructed so they are readily accessible to and usable by persons with disabilities. This chapter provides accessibility criteria for the design of pedestrian facilities that meet applicable state and federal standards.

The pedestrian facilities included in a project are determined during the planning phase based on: access control of the highway; local transportation plans; comprehensive plans and other plans (such as Walk Route Plans developed by schools and school districts); the roadside environment; pedestrian volumes; user age group(s); and the continuity of local walkways along or across the roadway.

When developing pedestrian facilities within a limited amount of right of way, designers can be faced with multiple challenges. It is important that designers become familiar with the ADA accessibility criteria in order to appropriately balance intersection design with the often competing needs of pedestrians and other roadway users.

Similar to the roadway infrastructure, pedestrian facilities (and elements) require periodic maintenance in order to prolong the life of the facility and provide continued usability. Title II of the ADA requires that all necessary features be accessible and maintained in operable working condition for use by individuals with disabilities.

1510.02 References

(1) Federal/State Laws and Codes

ADA (28 CFR Part 35, as revised September 15, 2010)

23 CFR Part 652, Pedestrians and Bicycle Accommodations and Projects

49 CFR Part 27, Nondiscrimination on the Basis of Disability in Programs or Activities Receiving Federal Financial Assistance (Section 504 of the Rehabilitation Act of 1973 implementing regulations)

RCW 35.68, Sidewalks, gutters, curbs and driveways – All cities and towns

RCW 35.68.075, Curb ramps for persons with disabilities – Required – Standards and Requirements

RCW 46.04.160, Crosswalk (definition)

RCW 46.61, Rules of the Road

RCW 47.24.020, City streets as part of state highways – Jurisdiction, control

(2) Design Guidance

Manual on Uniform Traffic Control Devices for Streets and Highways, USDOT, FHWA; as adopted and modified by Chapter 468-95 WAC “Manual on uniform traffic control devices for streets and highways” (MUTCD)

www.wsdot.wa.gov/publications/manuals/mutcd.htm

Revised Draft Guidelines for Accessible Public Rights-of-Way (PROWAG), November 23, 2005, U.S. Access Board. The current best practices for evaluation and design of pedestrian facilities in the public right of way per the following FHWA Memoranda:

<http://www.fhwa.dot.gov/environment/bikeped/prwaa.htm>

http://www.fhwa.dot.gov/civilrights/memos/ada_memo_clarificationa.htm

www.access-board.gov/prowac/draft.htm

Standard Plans for Road, Bridge, and Municipal Construction (Standard Plans), M 21-01, WSDOT

www.wsdot.wa.gov/publications/manuals/m21-01.htm

1991 ADA Standards for Accessible Design, U.S. Department of Justice (USDOJ); consists of 28 CFR parts 35 & 36 and the *ADA Accessibility Guidelines for Buildings and Facilities (ADAAG)*, July 1991, U.S. Access Board. (For buildings and on-site facilities; usable if construction or alteration occurs prior to March 15, 2012.)

<http://www.access-board.gov/ada/>

ADA Standards for Accessible Design, USDOJ, 2010; consists of 28 CFR parts 35 & 36 and the *ADA and Architectural Barriers Act (ABA) Accessibility Guidelines for Buildings and Facilities (ADA-ABAAG)*; also referred to as the 2004 ADAAG), July 23, 2004, U.S. Access Board. (For buildings and on-site facilities; *usable* if construction or alteration occurs after September 15, 2010, but *required* if construction or alteration occurs on or after March 15, 2012.)

<http://www.access-board.gov/ada/>

ADA Standards for Transportation Facilities, USDOT, 2006; consists of 49 CFR Parts 37 & 38 and the *ADA and ABA Accessibility Guidelines for Buildings and Facilities (ADA-ABAAG)*; also referred to as the 2004 ADAAG), July 23, 2004, U.S. Access Board. (For transit, light rail, and similar public transportation facilities.)

<http://www.access-board.gov/ada/>

(3) Supporting Information

A Policy on Geometric Design of Highways and Streets (Green Book), AASHTO, Current version adopted by FHWA.

Field Guide for Accessible Public Rights of Way, WSDOT, 2010

☞ http://www.wsdot.wa.gov/publications/fulltext/roadside/ada_field_guide.pdf

Guide for the Planning, Design, and Operation of Pedestrian Facilities, AASHTO, 2004. Provides guidance on the planning, design, and operation of pedestrian facilities along streets and highways. Specifically, the guide focuses on identifying effective measures for accommodating pedestrians on public rights of way. It can be purchased through the AASHTO website.

Highway Capacity Manual, Transportation Research Board (TRB), 2000

Pedestrian Facilities Guidebook: Incorporating Pedestrians Into Washington's Transportation System, OTAK, 1997

☞ www.wsdot.wa.gov/publications/manuals/fulltext/m0000/pedfacgb.pdf

Pedestrian Facilities Users Guide – Providing Safety and Mobility, FHWA, 2002. Provides useful information regarding walkable environments; pedestrian crashes and their countermeasures; and engineering improvements for pedestrians.

☞ http://drusilla.hsrc.unc.edu/cms/downloads/pedfacility_userguide2002.pdf

Roadside Manual, M 25-30, WSDOT

☞ www.wsdot.wa.gov/publications/manuals/m25-30.htm

“Special Report: Accessible Public Rights-of-Way – Planning & Designing for Alterations,” Public Rights-of-Way Access Advisory Committee, July 2007

☞ www.access-board.gov/prowac/alterations/guide.htm

Understanding Flexibility in Transportation Design – Washington, WSDOT, 2005

☞ www.wsdot.wa.gov/research/reports/600/638.1.htm

Washington State Bicycle Facilities and Pedestrian Walkways Plan

☞ www.wsdot.wa.gov/bike/bike_plan.htm

1510.03 Definitions

accessible Usable by persons with disabilities (ADA compliant).

accessible pedestrian signal (APS) A device that communicates information about the “WALK” phase in audible and vibrotactile (vibrating surface that communicates information through touch, located on the accessible pedestrian signal button) formats.

accessible route See *pedestrian access route*.

ADA An abbreviation for the Americans with Disabilities Act of 1990. The ADA is a civil rights law that identifies and prohibits discrimination based on disability. Title II of the ADA requires public entities to design new pedestrian facilities or alter existing pedestrian facilities to be accessible to and usable by people with disabilities.

alternate pedestrian access route A temporary accessible route to be used when the existing pedestrian access route is blocked by construction, alteration, maintenance, or other temporary condition(s).

alteration A change to a facility in the public right of way that affects or could affect access, circulation, or use.

Alterations include, but are not limited to, renovation; rehabilitation; reconstruction; historic restoration; resurfacing of circulation paths or vehicular ways; or changes or rearrangement of structural parts or elements of a facility.

Alterations *do not* include:

- Spot pavement repair
- Liquid-asphalt sealing, chip seal (bituminous surface treatment), or crack sealing
- Lane restriping that does not alter the usability of the shoulder

bituminous surface treatment (BST) Also known as a seal coat or chip seal, a BST is a thin, protective wearing surface that is applied to the pavement.

buffer A space measured from the back of the curb to the edge of the sidewalk that could be treated with plantings or alternate pavement, or be used for needs such as drainage treatment or utility placement.

clear width The unobstructed width within a pedestrian circulation path. The clear width within a pedestrian circulation path must meet the accessibility criteria for a pedestrian access route.

construction impact zone The area in which an alteration to an existing facility takes place (also known as the project footprint). For a paving project, this zone encompasses the paving limits and all curb ramps adjacent to the paving limits.

counter slope The slope of the gutter or roadway at the foot of a curb ramp or landing where it connects to the roadway, measured along the axis of the running slope extended (see Exhibits 1510-9 and 1510-11).

cross slope The slope measured perpendicular to the direction of travel.

crosswalk A marked or unmarked pedestrian crossing, typically at an intersection, that connects the pedestrian access routes on opposite sides of a roadway. A crosswalk must meet accessibility criteria.

A crosswalk is also defined as:

- "...the portion of the roadway between the intersection area and a prolongation or connection of the farthest sidewalk line or in the event there are no sidewalks then between the intersection area and a line ten feet therefrom, except as modified by a marked crosswalk" (RCW 46.04.160).
- "(a) That part of a roadway at an intersection included within the connections of the lateral lines of the sidewalks on opposite sides of the highway measured from the curbs or in the absence of curbs, from the edges of the traversable roadway, and in the absence of a sidewalk on one side of the roadway, the part of the roadway included within the extension of the lateral lines of the sidewalk at right angles to the center line; (b) any portion of a roadway at an intersection or elsewhere distinctly indicated as a pedestrian crossing by lines on the surface, which might be supplemented by contrasting pavement texture, style, or color" (MUTCD, 2003; *Guide for the Planning, Design, and Operation of Pedestrian Facilities*, AASHTO, 2004).

curb extension A curb and sidewalk bulge or extension out into the parking lane used to decrease the length of a pedestrian crossing and increase visibility for the pedestrian and driver.

curb ramp A combined ramp and landing to accomplish a change in level at a curb. This element provides street and sidewalk access to pedestrians with mobility impairments.

parallel curb ramp A curb ramp design where the sidewalk slopes down to a landing at road level with the running slope of the ramp in line with the direction of sidewalk travel. (See Exhibits 1510-10 and 1510-11.)

perpendicular curb ramp A curb ramp design where the ramp path is perpendicular to the curb and meets the gutter grade break at a right angle (see Exhibits 1510-8 and 1510-9).

detectable warning surface A tactile surface feature of truncated dome material built into or applied to the walking surface to alert persons with visual impairments of vehicular ways. Federal yellow is the color used on WSDOT projects to achieve visual contrast. Colors other than federal yellow that meet the light-on-dark/dark-on-light requirement may be used on projects where cities have jurisdiction. (Detectable warning surfaces are detailed in the *Standard Plans*.)

driveway A vehicular access point that provides access to or from a public roadway.

element An architectural or mechanical component or design feature of a space, site, or public right of way.

facility All or any portion of buildings, structures, improvements, elements, and pedestrian or vehicular routes located in a public right of way.

feature A component of a pedestrian access route, such as a curb ramp, driveway, crosswalk, or sidewalk.

flangeway gap The gap for the train wheel at a railroad crossing. The space between the inner edge of a rail and the pedestrian crossing surface.

grade break The intersection of two adjacent surface planes of different grade.

landing A level paved area, within or at the top and bottom of a stair or ramp, designed to provide turning and maneuvering space for wheelchair users and as a resting place for pedestrians.

maximum extent feasible From the U.S. Department of Justice, 28 CFR Part 36.402, Alterations. The phrase “to the maximum extent feasible” applies to “the occasional case where the nature of an existing facility makes it virtually impossible to comply fully with applicable accessibility standards through a planned alteration.”

This phrase also refers to a stand-alone piece of design documentation that WSDOT uses to record its reasons for not being able to achieve full ADA compliance in alteration projects (called a Maximum Extent Feasible document).

midblock pedestrian crossing A marked pedestrian crossing located between intersections.

passenger loading zone An area provided for pedestrians to board/disembark a vehicle.

pedestrian Any person afoot or using a wheelchair (manual or motorized) or means of conveyance (other than a bicycle) propelled by human power, such as skates or a skateboard.

pedestrian access route (PAR) (synonymous with **accessible route**) A continuous, unobstructed walkway within a pedestrian circulation path that provides accessibility. Pedestrian access routes consist of one or more of the following pedestrian facilities: walkways/sidewalks, curb ramps (excluding flares), landings, crosswalks, pedestrian overpasses/underpasses, access ramps, elevators, and platform lifts.

Note: Not all transportation facilities need to accommodate pedestrians. However, those that do accommodate pedestrians need to have an accessible route.

pedestrian circulation path A prepared exterior or interior way of passage provided for pedestrian travel. Includes independent walkways, shared-use paths, sidewalks, and other types of pedestrian facilities. All pedestrian circulation paths are required to contain a continuous pedestrian access route that connects to all adjacent pedestrian facilities, elements, and spaces that are required to be accessible.

pedestrian facilities Walkways such as sidewalks, walking and hiking trails, shared-use paths, pedestrian grade separations, crosswalks, and other improvements provided for the benefit of pedestrian travel. Pedestrian facilities are intended to be accessible routes.

pedestrian overpass or underpass A grade-separated pedestrian facility, typically a bridge or tunnel structure over or under a major highway or railroad that allows pedestrians to cross.

pedestrian refuge island An island in the roadway that physically separates the directional flow of traffic, provides pedestrians with a place of refuge, and reduces the crossing distance. Note: Islands with cut-through paths are more accessible to persons with disabilities than are raised islands with curb ramps.

person with disability An individual who has an impairment, including a mobility, sensory, or cognitive impairment, that results in a functional limitation in access to and use of a building or facility.

railroad track crossings Locations where a pedestrian access route intersects and crosses a railroad track.

raised median A raised island in the center of a road used to restrict vehicle left turns and side street access. Note: Islands with cut-through paths are more accessible to persons with disabilities than are raised islands with curb ramps.

ramp A walking surface with a running slope steeper than 20H:1V (5%).

roadway See Chapter 1140.

running slope A slope measured in the direction of travel, normally expressed as a percent.

sidewalk A walkway along a highway, road, or street that is intended for use by pedestrians.

sidewalk ramp See *curb ramp*.

site A parcel of land bounded by a property line or a designated portion of a public right of way.

street furniture Sidewalk equipment or furnishings, including garbage cans, benches, parking meters, and telephone booths.

traffic calming Design techniques that have been shown to reduce traffic speeds and unsafe maneuvers. These techniques can be stand-alone or used in combination, and they include lane narrowing, curb extensions, surface variations, and visual clues in the vertical plane.

transitional segments Segments of a pedestrian circulation path that blend between existing undisturbed pedestrian facilities and newly altered pedestrian facilities. Use of transitional segments may permit the work of the alteration to more nearly meet the new construction standards. At a later time, when other segments of the pedestrian circulation path are altered, the noncomplying transitional segments can be removed and replaced with pedestrian facilities that meet the accessibility criteria.

traveled way A route provided for vehicular traffic. The portion of the roadway intended for the movement of vehicles, exclusive of shoulders and lanes for parking, turning, and storage for turning.

truncated domes Small raised protrusions of a detectible warning surface that are readily detected and understood by a person with a vision-impairment who uses the sense of touch for guidance. The *Standard Plans* shows the appropriate pattern and dimensions.

universal access Access for all persons regardless of ability or stature.

walk interval That phase of a traffic signal cycle during which the pedestrian is to begin crossing, typically indicated by a WALK message or the walking person symbol and its audible equivalent.

walkway The continuous portion of the pedestrian access route that is connected to street crossings by curb ramps.

1510.04 Policy

(1) General

It is WSDOT policy to provide appropriate pedestrian facilities along and across sections of state routes and city streets as an integral part of the transportation system. Federal Highway Administration (FHWA) and WSDOT policy is that bicycle and pedestrian facilities be given full consideration in the planning and design of new construction and reconstruction highway projects, except where bicycle and pedestrian use is prohibited. The WSDOT planning process determines *what* facilities or services will be provided *where* in accordance with applicable federal and state laws and codes.

(2) Jurisdiction

Proposed projects in public rights of way must address ADA compliance as described in this chapter. (See 1510.05 for ADA requirements by project type.) Regardless of which public agency has jurisdiction within the right of way, the public agency that is

sponsoring the project is responsible for ensuring that ADA compliance is addressed on their project. When project work occurs inside an incorporated city that has jurisdiction beyond the curbs (RCW 47.24.020), pedestrian facilities may be designed using the city design standards adopted in accordance with RCW 35.78.030 and the most current ADA requirements. Document the coordination with the city in the Design Documentation Package (DDP). Refer to Chapter 300 for discussion about the DDP.

When city streets form a part of the state highway system within the corporate limits of cities and towns, the city has full responsibility for and control over any facilities beyond the curbs and, if no curb is installed, beyond that portion of the highway used for highway purposes (RCW 47.24.020). The title to limited access facilities within incorporated cities and towns remains with the state. If a turnback agreement has not been completed, the state maintains full jurisdiction within these areas (see Chapters 510, 520, and 530).

(3) Maintenance

As noted in 1510.01, Title II of the ADA requires that a public entity maintain in operable working condition those features of facilities and equipment that are required to be readily accessible to and usable by persons with disabilities.

1510.05 ADA Requirements by Project Type

Wherever pedestrian facilities are intended to be a part of the transportation facility, federal regulations (28 CFR Part 35) require that those pedestrian facilities meet ADA guidelines. All new construction or alteration of existing transportation facilities must be designed and constructed to be accessible to and usable by persons with disabilities. FHWA is one of the federal agencies designated by the Department of Justice to ensure compliance with the ADA for transportation projects.

(1) New Construction Projects

New construction projects address the construction of a new roadway, interchange, or other transportation facility where none existed before. For these projects, pedestrians' needs are assessed and included in the project. All pedestrian facilities included in these projects must meet the accessibility criteria when built.

(2) Alteration Projects

Any project that has the potential to affect pedestrian access, circulation, or use of a pedestrian facility is classified as an alteration project. Alteration projects include, but are not limited to, renovation; rehabilitation; reconstruction; historic restoration; resurfacing of circulation paths or vehicular ways; or changes or rearrangement of structural parts or elements of a facility. Where existing elements or spaces are altered, each altered element or space within the limits of the project shall comply with the applicable requirements for new construction to the maximum extent feasible.

The following are some examples of project types that are classified as alteration projects and can potentially trigger ADA requirements:

- HMA overlay or inlay
- Traffic signal installation or retrofit
- Roadway widening

- Realignment of a roadway (vertical or horizontal)
- Sidewalk improvements
- PCCP panel repair/replacement
- Bridge replacement
- Raised channelization

The following are not considered alterations:

- Spot pavement repair
- Liquid-asphalt sealing, chip seal (BST), or crack sealing
- Lane restriping that does not alter the usability of the shoulder

If there is uncertainty as to whether a project meets the definition of an alteration project, consult with the Regional ADA Coordinator.

The following apply to alteration projects:

- All new pedestrian facilities included in an alteration project that are put in place within an existing developed right of way must meet new construction requirements to the maximum extent feasible. All new pedestrian facilities included in an alteration project must meet new construction requirements to the maximum extent feasible.
- All existing pedestrian facilities disturbed by construction of an alteration project must be replaced. The replacement facilities must meet new construction requirements to the maximum extent feasible.
- An alteration project shall not decrease or have the effect of decreasing the accessibility of a pedestrian facility or an accessible connection to an adjacent building or site below the ADA accessibility requirements in effect at the time of the alteration.
- Within the construction impact zone of an alteration project, any existing connection from a pedestrian access route to a crosswalk (marked or unmarked) that is missing a required curb ramp must have a curb ramp installed that meets new construction requirements to the maximum extent feasible. (See 1510.09(2) for curb ramp accessibility criteria.)
- A crosswalk served by a curb ramp must also have an existing curb ramp in place on the receiving end unless there is no curb or sidewalk on that end of the crosswalk (RCW 35.68.075). If there is no existing curb ramp in place on the receiving end, an accessible curb ramp must be provided. This requirement must be met regardless of whether the receiving end of the crosswalk is located within the project's limits.
- Within the construction impact zone of an alteration project, evaluate all existing curb ramps to determine whether curb ramp design elements meet the accessibility criteria. (See 1510.09(2) for curb ramp accessibility criteria.) Modify existing curb ramps that do not meet the accessibility criteria to meet new construction requirements to the maximum extent feasible. This may also trigger modification of other adjacent pedestrian facilities to incorporate transitional segments in order to ensure specific elements of a curb ramp will meet the accessibility criteria.
- Within the construction impact zone of an alteration project that includes HMA overlay (or inlay) of an existing roadway and *does not* include reconstruction, realignment, nor widening of the roadway, evaluate all existing marked and

unmarked crosswalks. (See 1510.10(2) for crosswalk accessibility criteria.)
If it is not possible to meet the new construction requirements for crosswalks, document this in the DDP.

- Within the construction impact zone of an alteration project that includes reconstruction, realignment, or widening of the roadway, evaluate all existing crosswalks (marked or unmarked) to determine whether crosswalk design elements meet the accessibility criteria. (See 1510.10(2) for crosswalk accessibility criteria.) Modify crosswalk slopes to meet new construction requirements to the maximum extent feasible.
- It may not always be possible to fully meet the new construction standards during alterations of existing facilities. If such a situation is encountered, consult with the Regional ADA Coordinator to develop a workable solution to meet the accessibility requirements to the maximum extent feasible. If it is determined to be virtually impossible to meet the accessibility criteria, document the decision via a Maximum Extent Feasible (MEF) document. Cost is not to be used as a justification for not meeting the accessibility criteria. Physical terrain or site conditions that would require structural impacts, environmental impacts, or unacceptable impacts to the community in order to achieve full compliance with the accessibility criteria are some of the factors that can be used to determine that the maximum extent feasible is achieved. The MEF document will be reviewed by the appropriate Assistant State Design Engineer (ASDE) and the HQ ADA Compliance Manager. If acceptable, the MEF document will be approved and included in the DDP. Depending on the scale and extent of the MEF document, documentation may be approved in the region with HQ ADA Compliance Manager and ASDE concurrence.

1510.06 Pedestrian Circulation Paths

Pedestrian circulation paths are prepared exterior or interior ways of passage provided for pedestrian travel. They include independent walkways, sidewalks, shared-use paths, and other types of pedestrian facilities. Pedestrian circulation paths can either be immediately adjacent to streets and highways or separated from them by a buffer. Examples of pedestrian circulation paths are shown in Exhibit 1510-1.

When the pedestrian circulation path is located behind guardrail, address protruding bolts. Installation of a rub rail or a “W-beam” guardrail on the pedestrian side of the posts are options to mitigate potential snagging that also serve as a guide for sight-impaired pedestrians.

Provide a smooth finish to vertical surfaces adjacent to a pedestrian circulation path to mitigate potential snagging or abrasive injuries from accidental contact with the surface. Where adjacent walkway segments diverge, such as can occur if a parallel curb ramp does not occupy the entire width of a pedestrian circulation path, any resulting drop-offs must be protected to prevent trips or falls.

When relocation of utility poles and other fixtures is necessary for a project, determine the impact of their new location on all pedestrian circulation paths. Look for opportunities to relocate obstructions, such as existing utility objects, from the pedestrian circulation path.



Pedestrian Circulation Paths

Exhibit 1510-1

Highway shoulders are an extension of the roadway and are not typically considered pedestrian facilities. Pedestrians are allowed to use many state highways. Although pedestrians are allowed to travel along the shoulder in these cases, its main purpose is to provide an area for disabled vehicles, a recovery area for errant vehicles, and positive drainage away from the roadway.

Shoulders may serve as a pedestrian facility when sidewalks are not provided. If pedestrian generators, such as bus stops, are present and pedestrian usage is evident, a 4-foot-wide paved shoulder is adequate.

Where pedestrian traffic is evident, consider a separate pedestrian circulation path during the planning and programming of the project. Consult with the State Bicycle and Pedestrian Coordinator.

(1) Accessibility Criteria for Pedestrian Circulation Paths

The following criteria apply across the entire width of the pedestrian circulation path, not just within the pedestrian access route.

(a) Vertical Clearance

- The minimum vertical clearance for objects that protrude into or overhang a pedestrian circulation path is 80 inches.
- If the minimum vertical clearance cannot be provided, railings or other barriers shall be provided. The leading bottom edge of the railing or barrier shall be located 27 inches maximum above the finished surface for cane detection.

Note: Per the MUTCD, the vertical clearance to the bottom of signs is 7 feet (84 inches.)

(b) Horizontal Encroachment

- Protruding objects on pedestrian circulation paths shall not reduce the clear width of the pedestrian access route to less than 4 feet, exclusive of the curb.

Note: If an object must protrude farther than 4 inches into a pedestrian circulation path at a height that is greater than 27 inches and less than 80 inches above the finished surface, then it must be equipped with a warning device that is

detectable by a vision-impaired person who navigates with a cane. The minimum clear width of the pedestrian access route must still be provided.

(c) Post-Mounted Objects

- Objects mounted on posts, at a height that is greater than 27 inches and less than 80 inches above the finished surface, shall not protrude more than 4 inches into a pedestrian circulation path.

Note: If an object must protrude farther than 4 inches into a pedestrian circulation path at a height that is greater than 27 inches and less than 80 inches above the finished surface, then it must be equipped with a warning device that is detectable by a vision-impaired person who navigates with a cane. The minimum clear width of the pedestrian access route must still be provided.

- Where a sign or other obstruction on a pedestrian circulation path is mounted on multiple posts, and the clear distance between the posts is greater than 12 inches, the lowest edge of the sign or obstruction shall be either 27 inches maximum or 80 inches minimum above the finished surface.

1510.07 Pedestrian Access Routes (PARs)

All pedestrian circulation paths (PCPs) are required to contain a continuous pedestrian access route (see Exhibit 1510-2) that connects to all adjacent pedestrian facilities, elements, and spaces that are required to be accessible. Pedestrian access routes consist of one or more of the following pedestrian facilities: walkways/sidewalks, crosswalks, curb ramps (excluding flares), landings, pedestrian overpasses/underpasses, access ramps, elevators, and platform lifts.

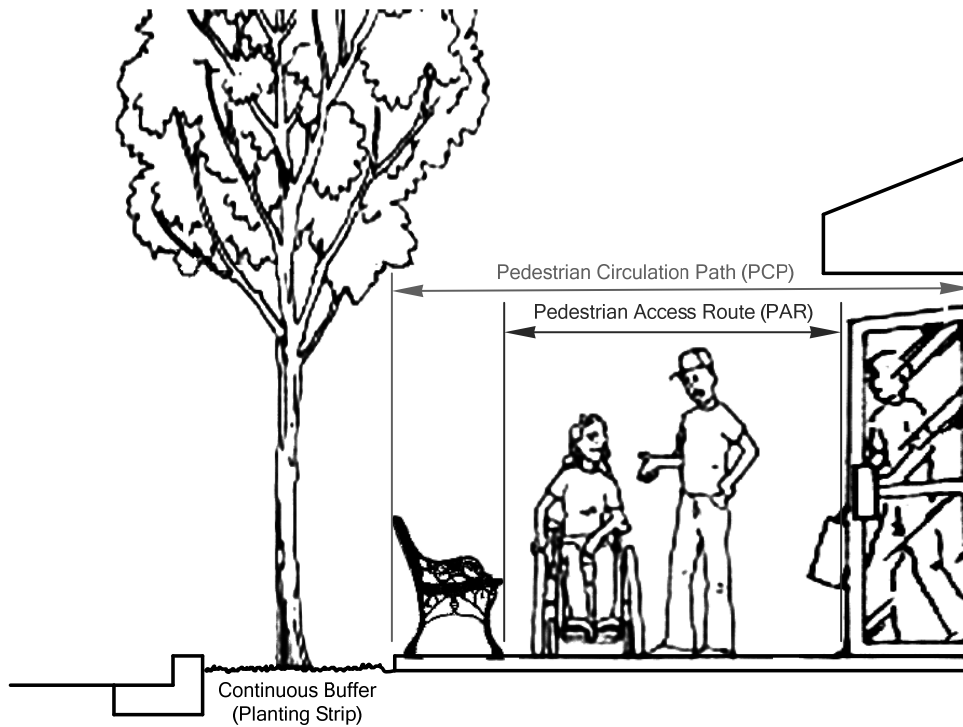

With Continuous Buffer

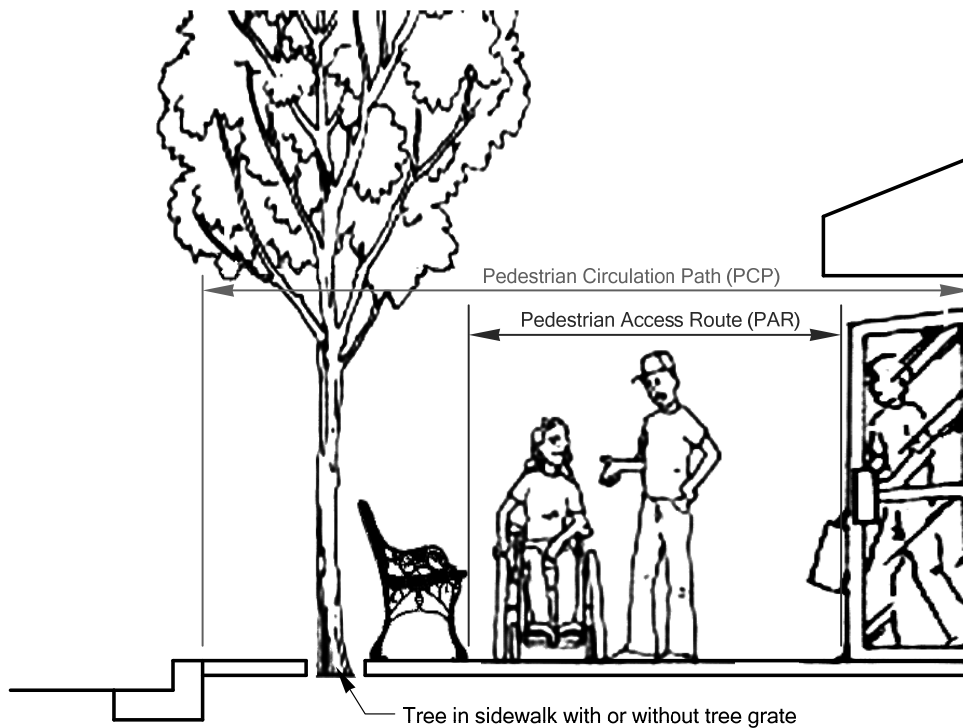

Without Continuous Buffer

Relationship Between Pedestrian Circulation Paths and Pedestrian Access Routes

Exhibit 1510-2

(1) Accessibility Criteria for Pedestrian Access Routes**(a) Clear Width**

- The minimum continuous and unobstructed clear width of a pedestrian access route shall be 4 feet, exclusive of the width of the curb.
- Pedestrian access routes that are less than 5 feet in clear width, exclusive of the width of the curb, shall provide passing spaces at intervals no further apart than 200 feet. Passing spaces shall be 5 feet wide minimum for a minimum distance of 5 feet.



This Exhibit depicts a condition where the PAR has been reduced to less than the minimum clear width, resulting in an unacceptable condition.

Obstructed Pedestrian Access Route***Exhibit 1510-3*****(b) Grade and Cross Slope**

- The cross slope of a pedestrian access route shall be 2% maximum.

Note: It is recommended that cross slopes be designed to be less than the allowed maximum to allow for some tolerance in construction. For example: design for a maximum 1.5% cross slope (rather than 2% maximum).

Exceptions:

1. Midblock crosswalks – The cross slope of the crosswalk and any connected curb ramp are permitted to match street or highway grade.
 2. Crosswalks without stop sign control – The cross slope of the crosswalk can be up to 5% maximum.
- Where a pedestrian access route is contained within the highway right of way, its grade shall not exceed the general grade established for the adjacent roadway.
Exception: The maximum grade in a crosswalk (marked or unmarked) is 5%, measured parallel to the direction of pedestrian travel in the crosswalk.
 - Where a pedestrian access route is not contained within the highway right of way, the maximum running slope allowed is 5% unless designed as an access ramp. (See 1510.15(2) for access ramp accessibility criteria.)
 - For additional criteria when a pedestrian access route is supported by a structure, see 1510.14.

(c) Surface

- The surface of the pedestrian access route shall be firm, stable, and slip resistant. Use hard surfaces like cement or asphalt concrete surfaces; crushed gravel is not considered to be a stable, firm surface.
- Vertical alignment shall be planar within curb ramps, landings, and gutter areas within the pedestrian access route and within clear spaces for accessible pedestrian signals, street furniture, and operable parts.
- Grade breaks shall be flush.
- Surface discontinuities (see Exhibit 1510-4) on existing surfaces in the pedestrian access route (such as at the joints of settled or upheaved sidewalk panels) may not exceed ½ inch maximum. Vertical discontinuities between ¼ inch and ½ inch maximum shall be beveled at 2H:1V minimum. Apply the bevel across the entire level change.

Exception: No surface discontinuity is allowed at the connection between an existing curb ramp or landing and the gutter. This grade break must be flush.

**Surface Discontinuities (Noncompliant)**

Exhibit 1510-4

- Gratings, access covers, utility objects, and other appurtenances shall not be located on curb ramps, landings, or gutters within the pedestrian access route.
- Locate gratings, access covers, utility objects, and other appurtenances outside the pedestrian access route on walkways and sidewalks. Where this is not possible, ensure covers, grates, and lids are designed to be slip resistant and are installed flush with the surrounding surface (see the *Standard Plans*).

(d) Horizontal Openings

- Any sidewalk joints or gratings that are in the pedestrian access route shall not permit passage of a sphere more than ½ inch in diameter.
- Elongated openings shall be placed so that the long dimension is perpendicular to the dominant direction of travel.

- Openings for wheel flanges at pedestrian crossings of nonfreight rail track shall be 2½ inches maximum (3 inches maximum for freight rail track).
- For additional requirements when a pedestrian access route crosses a railroad, see 1510.13.

1510.08 Sidewalks

Sidewalks are one type of pedestrian circulation path. (See 1510.06 for pedestrian circulation path accessibility criteria.) Plan the design of sidewalks carefully to include a pedestrian access route that provides universal access. (See 1510.07 for pedestrian access route accessibility criteria.) Sidewalk design elements are found in Exhibit 1510-6 and details for raised sidewalks are shown in the *Standard Plans*. Wherever appropriate, make sidewalks continuous and provide access to side streets. The most pleasing and comfortable installation for the pedestrian is a sidewalk separated from the traveled way by a planted buffer. This provides a greater separation between vehicles and pedestrians than curb alone.

(1) Sidewalk and Buffer Widths

Where a sidewalk is separated from the roadway by only a curb, the WSDOT minimum sidewalk width is 6 feet (excluding the curb). Note: When evaluating existing sidewalk that is at least 5 feet wide (excluding the curb) and meets all other accessibility criteria, it should be documented as a Design Exception that does not require reconstruction.

Where a sidewalk is separated from the roadway by a buffer (see Exhibit 1510-5) that is at least 3 feet wide (excluding the curb), the WSDOT minimum sidewalk width is 5 feet.

If trees or shrubs are included in a buffer, coordinate with the region or HQ Landscape Architect and refer to the *Roadside Manual*. Take into account Design Clear Zone guidelines (see Chapter 1600). Design subsurface infrastructure (such as structural soils) and select plants whose root systems do not cause sidewalks to buckle or heave. Coordinate buffer planting with maintenance personnel.

Where possible, strive to accommodate snow storage while keeping the pedestrian route free of snow accumulation. Make sure maintenance access is not obstructed. Shoulders, bike lanes, and on-street parking are not considered buffers, but they do offer the advantage of further separation between vehicles and pedestrians.



Sidewalks With Buffers

Exhibit 1510-5

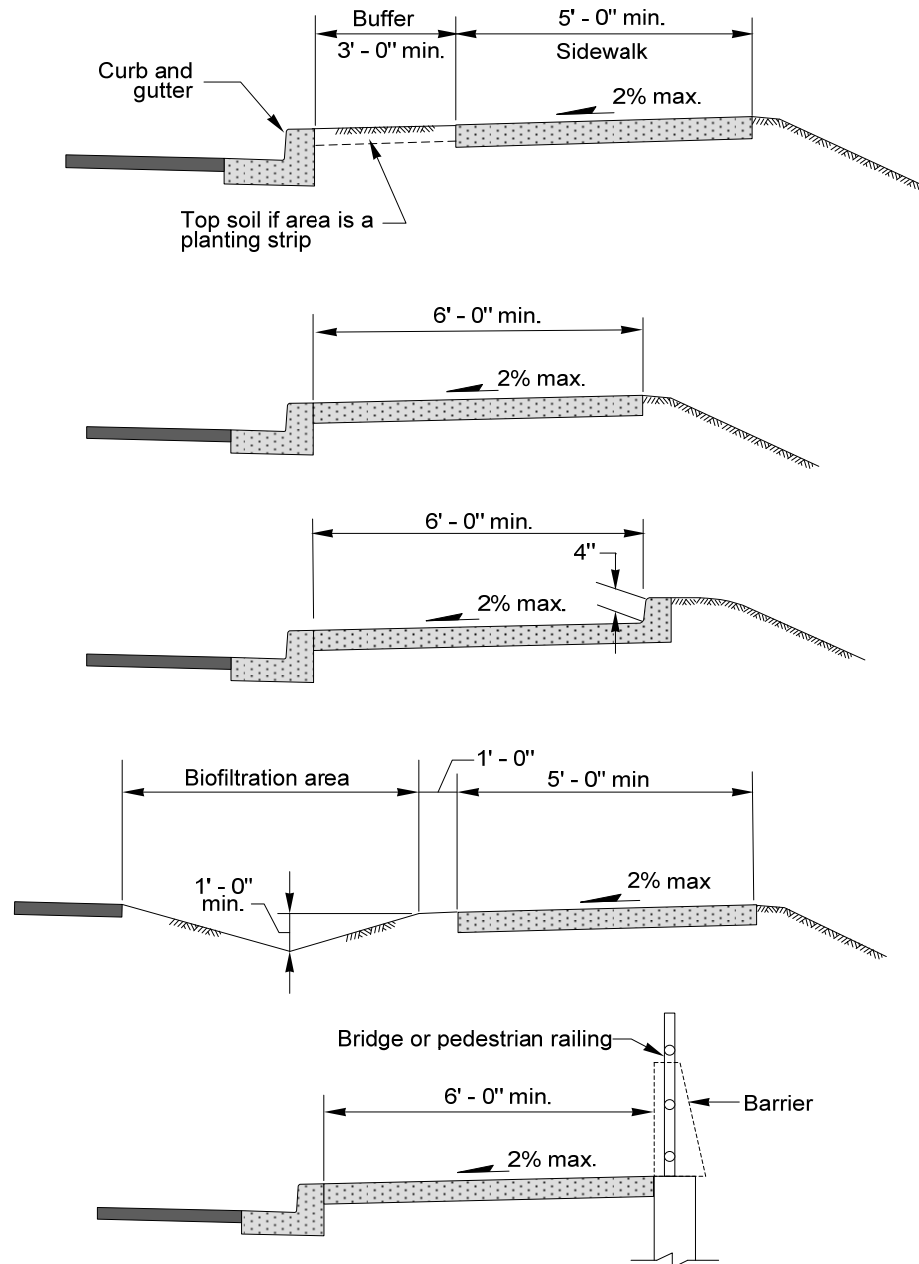
**Notes:**

If vertical drop is within the Design Clear Zone and the posted speed is > 35 mph, then barrier may be needed (see Chapter 1600).

If vertical drop is >2 feet 6 inches and barrier is not needed, then railing is indicated.

If vertical drop is < 2 feet 6 inches and barrier is not needed, then a 4-inch curb at back of sidewalk is adequate.

General:

See the *Standard Plans* for details on slopes at back of sidewalk.

See Chapter 1230 for slope selection criteria.

Sidewalks may be sloped away from the roadway for stormwater treatment (see the *Highway Runoff Manual*).

Typical Sidewalk Designs*Exhibit 1510-6*

(2) Sidewalks at Driveways

Provide a pedestrian access route where driveways intersect a pedestrian circulation path (see Exhibit 1510-7). The *Standard Plans* shows details of driveway designs that provide a pedestrian access route. (See 1510.06 and 1510.07 for accessibility criteria.)



Typical Driveways
Exhibit 1510-7

1510.09 Curb Ramps

Curb ramps provide an accessible connection from a raised sidewalk down to the roadway surface. A curb ramp, or combination of curb ramps, is required to connect pedestrian access routes to crosswalks (marked or unmarked) where curbs and sidewalks are present, except where pedestrian crossing is prohibited. (See 1510.10(2)(c) for guidance on closed crossings and Exhibit 1510-16 for examples.)

For new construction projects, provide a curb ramp oriented in each direction of pedestrian travel within the width of the crosswalk it serves. For alteration projects, a curb ramp oriented in each direction of pedestrian travel within the width of the crosswalk it serves is desirable.

Every curb ramp must have a curb ramp at the other end of the crosswalk it serves unless there is no curb or sidewalk on that side (RCW 35.68.075).

Curb ramps are also required at midblock crossings where curbs and sidewalks are present.

(1) Types of Curb Ramps

Different types of curb ramps can be used: perpendicular, parallel, and combination. Carefully analyze and take into consideration drainage patterns, especially when designing a parallel or combination curb ramp installation.

(a) Perpendicular Curb Ramp

Perpendicular curb ramps (see Exhibits 1510-8 and 1510-9) are aligned to cut through the curb and meet the gutter grade break at a right angle. The landing is to be located at the top of the curb ramp.

1. Advantages

- Having the path of travel aligned to cross the gutter grade break at a right angle facilitates usage by individuals with mobility devices.
- The height of the ramp run relative to the gutter elevation may facilitate drainage.
- The height of the ramp run relative to the gutter elevation discourages vehicular traffic from cutting across the corner.
- On small-radius corners, the ramp alignment may be more closely aligned with the alignment of the crosswalk markings, which facilitates direction finding for the visually impaired.

2. Disadvantages

- The ramp run and landing might not fit within available right of way.
- On small-radius corners, the flares may not fit between closely spaced perpendicular curb ramps.
- On larger-radius corner there will be less facilitation of direction finding for the visually impaired due to the requirement that the path of travel cross the gutter grade break at a right angle.



Perpendicular Curb Ramp

Exhibit 1510-8

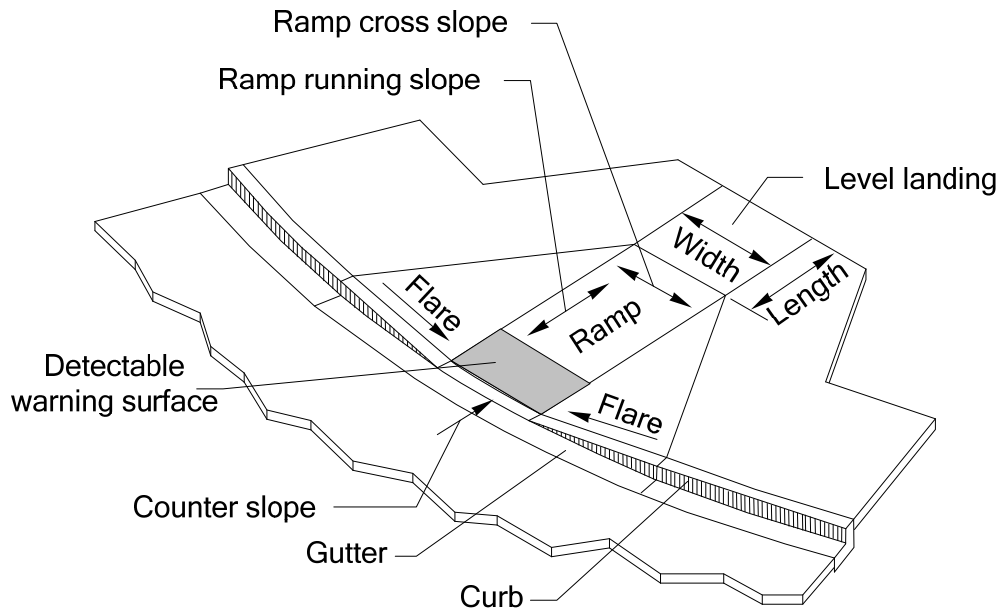

Perpendicular Curb Ramp Common Elements

Exhibit 1510-9

(b) Parallel Curb Ramp

Parallel curb ramps (see Exhibits 1510-10 and 1510-11) are aligned with their running slope in line with the direction of sidewalk travel, parallel to the curb. The landing is located at the bottom of the curb ramp.

1. Advantages

- Requires minimal right of way.
- Allows ramps to be extended to reduce ramp grade within available right of way.
- Provides edges on the side of the ramp that are detectable to vision-impaired pedestrians who navigate with a cane.

2. Disadvantages

- Depending on the style of parallel curb ramp, pedestrian through traffic on the sidewalk may need to negotiate two ramp grades instead of one, possibly making it more difficult to traverse for some.
- The installation of additional drainage features in the upstream gutter line may be necessary to prevent the accumulation of water or debris in the landing at the bottom of the ramp.



Parallel Curb Ramp
Exhibit 1510-10

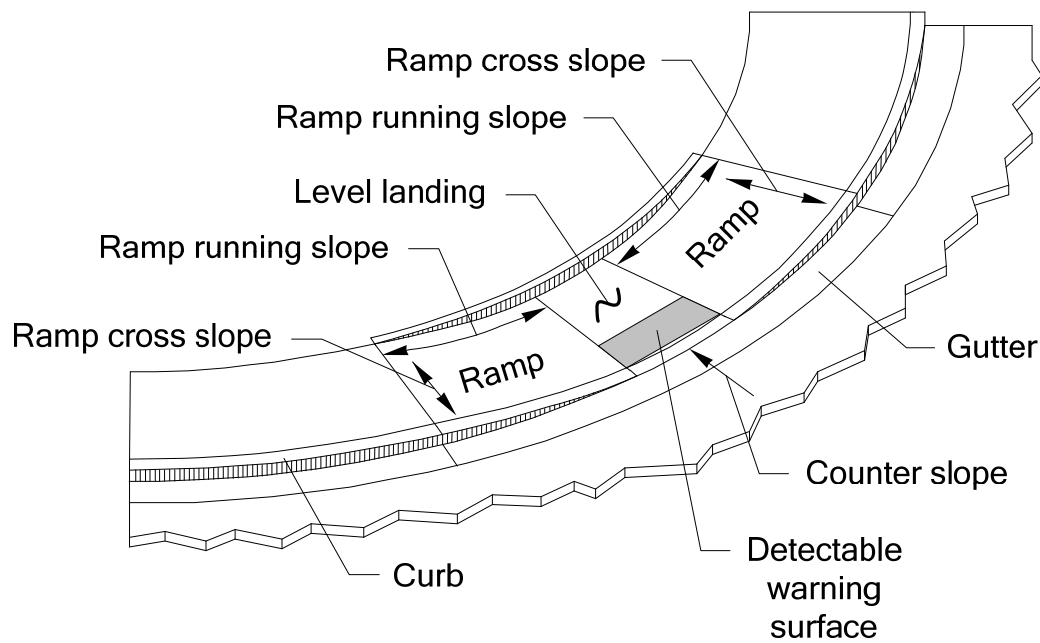

Parallel Curb Ramp Common Elements
Exhibit 1510-11

(c) Combination Curb Ramp

Combination curb ramps (see Exhibit 1510-12) combine the use of perpendicular and parallel types of curb ramps. Landings may be shared by multiple ramps in this application. Buffer areas and pedestrian curbing that define the pedestrian path of travel are inherent design elements for this type of curb ramp.

1. Advantages

- Allows the elevation difference between the sidewalk and the gutter line to be transitioned with multiple ramps. This can help achieve compliant ramp running slopes.
- Provides additional locations in the gutter line along the radius where drainage structures can be placed outside the pedestrian access route due to the well-defined pedestrian paths of travel.
- Can be constructed within available right of way when the right of way boundary is located at the back of the existing sidewalk, provided sufficient buffer width is available on the roadway side of the sidewalk.
- Provides a way to avoid the relocation of existing features such as utility poles, fire hydrants, and signal poles by incorporating those features into the buffer areas.
- The pedestrian curbing that defines the buffer areas and forms the curb returns for the perpendicular ramp connections facilitates direction finding for a vision-impaired person who navigates with a cane.

2. Disadvantages

- Has a higher construction cost than other curb ramp types due to extensive use of curbing and a larger footprint.
- Due to generally flatter ramp grades and multi-tiered ramp elements, inadequate drainage and accumulation of debris can occur.



Combination Curb Ramp
Exhibit 1510-12

(2) Accessibility Criteria for Curb Ramps

The accessibility criteria for pedestrian circulation paths and pedestrian access routes (see 1510.06 and 1510.07) also apply to curb ramps unless superseded by the following accessibility criteria specifically for curb ramps:

(a) Clear Width

- The clear width of curb ramps and their landings shall be 4 feet minimum, excluding flares.

(b) Running Slope

- The running slope shall be 8.3% maximum.

Note: It is recommended that running slopes be designed to be less than the allowed maximum to allow for some tolerance in construction. For example, design for a maximum 7.5% curb ramp running slope (rather than 8.3% maximum).

- The running slope of a perpendicular curb ramp shall intersect the gutter grade break at a right angle at the back of curb.
- The curb ramp maximum running slope shall not require the ramp length to exceed 15 feet.

(c) Cross Slope

- Not greater than 2%, measured perpendicular to the direction of travel.

Note: It is recommended that cross slopes be designed to be less than the allowed maximum to allow for some tolerance in construction. For example, design for a maximum 1.5% cross slope (rather than 2% maximum).

Exception: The cross slopes of curb ramps at midblock crossings are permitted to match the street or highway grade.

(d) Landing

A level landing is required either at the top of a perpendicular ramp or the bottom of a parallel curb ramp, as noted in 1510.09(1)(a) and (b) for the type of curb ramp used.

- Provide a landing that is at least 4 feet minimum length by 4 feet minimum width.
- The running and cross slopes of a curb ramp landing shall be 2% maximum.

Note: It is recommended that cross slopes be designed to be less than the allowed maximum to allow for some tolerance in construction. For example, design for a maximum 1.5% cross slope (rather than 2% maximum).

Exception: The running and cross slopes of landings for curb ramps at midblock crossings are permitted to match the street or highway grade.

(e) Flares

- Flared sides are to be used only where a pedestrian circulation path crosses the curb ramp from the side.
- Flared sides are to have a slope of 10% maximum, measured parallel to the back of curb.

(f) Counter Slope

- The counter slope of the gutter or street at the foot of a curb ramp or landing shall be 5% maximum.

(g) Detectable Warning Surfaces

- Required where curb ramps or landings connect to a roadway. (See the *Standard Plans* for placement details and other applications.)
- Detectable warning surfaces shall contrast visually (either light-on-dark or dark-on-light) with the adjacent walkway surface, gutter, street or highway.

Note: Federal yellow is the color used to achieve visual contrast on WSDOT projects. Within cities other contrasting colors may be used if requested by the city.

(h) Surfaces

- Surfaces shall be firm, stable, and slip resistant.
- Gratings, access covers, utility objects, and other appurtenances shall not be located on curb ramps, landings, or gutters within the pedestrian access route.

(i) Grade Breaks

- Vertical alignment shall be planar within curb ramp runs, landings, and gutter areas within the pedestrian access route.
- Grade breaks at the top and bottom of curb ramps shall be perpendicular to the direction of travel on the ramp run.
- Surface slopes that meet at grade breaks shall be flush.

(j) Clear Space

- Beyond the curb face where the bottom of a curb ramp or landing meets the gutter, a clear space of 4 feet minimum by 4 feet minimum shall be provided in the roadway that is contained within the width of the crosswalk and located wholly outside the parallel vehicle travel lane.

Note: Clear space is easily achieved when a separate curb ramp oriented in each direction of pedestrian travel within the width of the crosswalk it serves is provided.

(3) Curb Ramp Drainage

Surface water runoff from the roadway can flood the lower end of a curb ramp. Provide catch basins or inlets to prevent ponding at the base of curb ramps and landings. Exhibit 1510-13 shows examples of drainage structure locations. Verify that drainage structures will not be located in the pedestrian access route.

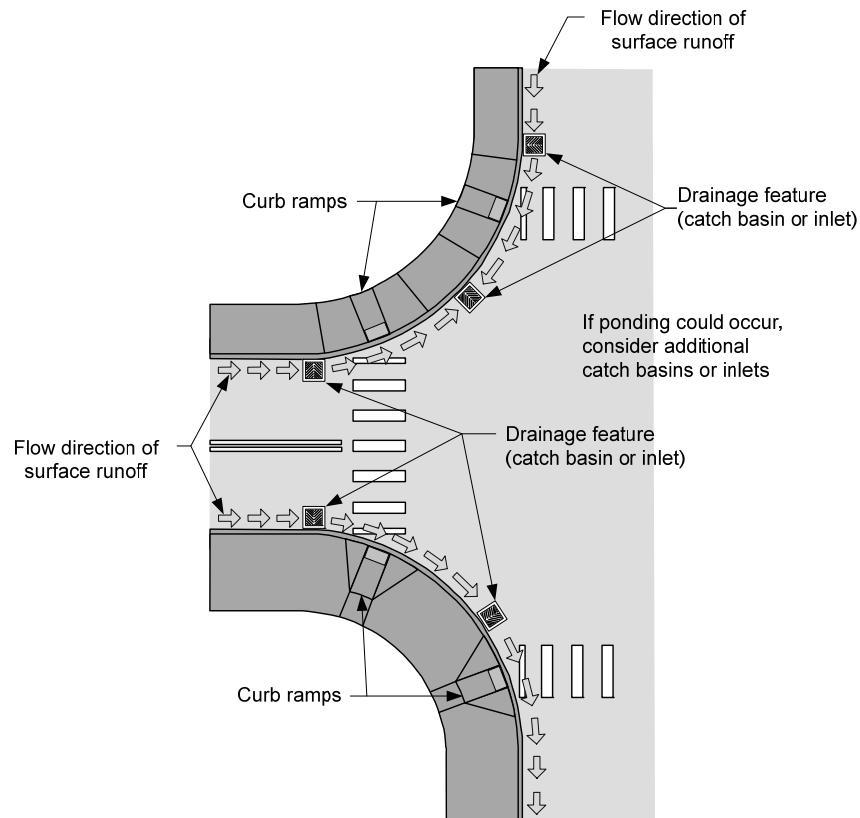

Typical Curb Ramp Drainage
Exhibit 1510-13

1510.10 Crosswalks

(1) Design Considerations for Crossing Facilities

Designing intersections for the needs of all users, including pedestrians, involves various considerations and tradeoffs. The following list presents design considerations for crossing facilities that meet pedestrians' needs:

- Minimize turning radii to keep speeds low. (See Chapter 1310 for design vehicle guidance.)
- Place crosswalks so they are visible and connect to the adjacent pedestrian facilities.
- Provide sight distance (driver to pedestrian; pedestrian to driver).
- Use a separate left-turn phase along with a "WALK/DON'T WALK" signal.
- Restrict or prohibit turns.
- Shorten crossing distance.
- Use a raised median/cut-through island for a pedestrian refuge.
- Use accessible pedestrian signals (APS).
- Use signing and delineation as determined by the region Traffic Engineer.
- Place crosswalks as close as practicable to the intersection traveled way.
- Provide pedestrian-level lighting.
- Consider the crosswalk location in relation to transit stops.
- All pedestrian crossings need to provide a PAR that meets the accessibility criteria.

(2) Crosswalks at Intersections

Provide a pedestrian access route within marked and unmarked pedestrian crossings. (See 1510.07 for accessibility criteria for pedestrian access routes.) Exhibit 1510-28 provides recommendations for determining pedestrian markings based on lane configuration, vehicular traffic volume, and speed. However, the region Traffic Engineer makes the final determination on appropriate signing and delineation.

(a) Unmarked Crossings

Legal crosswalks exist at all intersections, whether marked or not. An unmarked crosswalk (see Exhibit 1510-14) is the portion of the roadway behind a prolongation of the curb or edge of the through traffic lane and a prolongation of the farthest sidewalk connection or, in the event there are no sidewalks, between the edge of the through traffic lane and a line 10 feet from there (RCW 46.04.160).

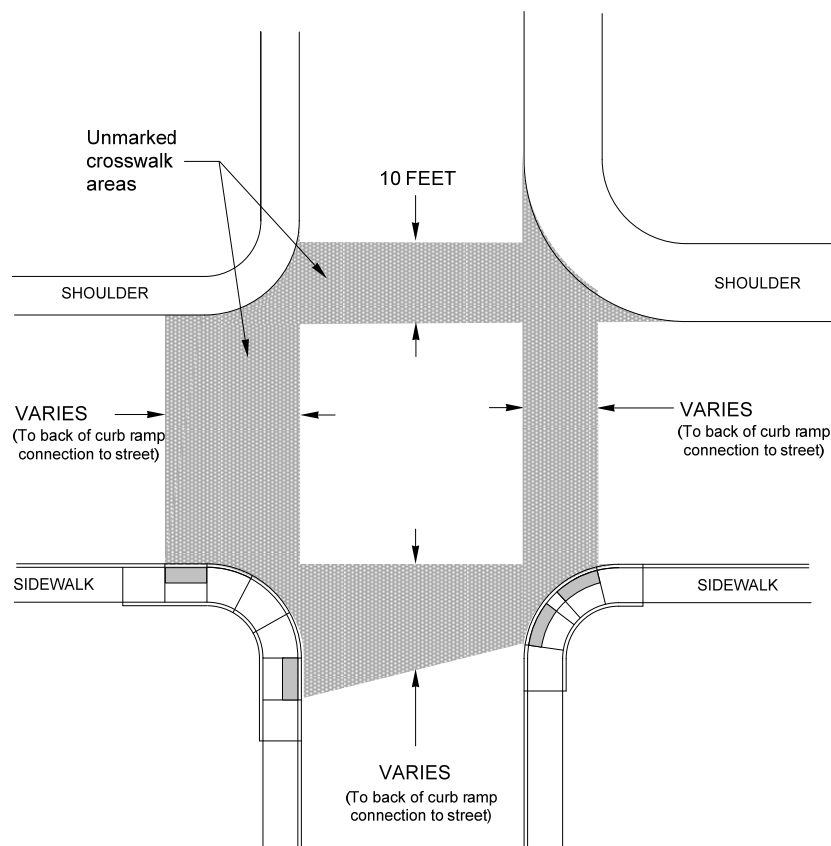

Unmarked Crosswalks

Exhibit 1510-14

(b) Marked Crossings

Marked crosswalks are used at intersections or midblock crossings. They are not to be used indiscriminately. Maintenance agreements and RCW 47.24.020(30) provide jurisdictional authority for decisions to mark crosswalks based on a population threshold of 25,000 and should be consulted prior to a decision to mark crosswalk. Consult region Traffic Offices for “best practices” for marking crosswalks based on intersection type.

The MUTCD is a good resource to use when evaluating locations for marking consideration.

Note: The installation of a midblock pedestrian crossing on a state highway is a design deviation that requires documentation and ASDE approval.

The desirable width for a marked crosswalk is 10 feet (6 feet minimum with justification). The preferred type of marked crosswalk is a longitudinal pattern known as a Ladder Bar, which is shown in the *Standard Plans* and Exhibit 1510-15. Stop and yield line dimensions and placement must conform to the MUTCD and are shown in the *Standard Plans*.

Communities sometimes request specially textured crosswalks (such as colored pavement, bricks, or other materials). Some textured materials may cause confusion for visually impaired pedestrians and can create discomfort for wheelchair users. These decorative crosswalks do not always fall within the legal definition of a marked crosswalk, and supplemental parallel white crosswalk lines are recommended to enhance visibility and delineate the crosswalk. For more information, see the MUTCD and the Local Agency Crosswalk Options website:

☞ www.wsdot.wa.gov/design/standards/plansheet/pm-2.htm

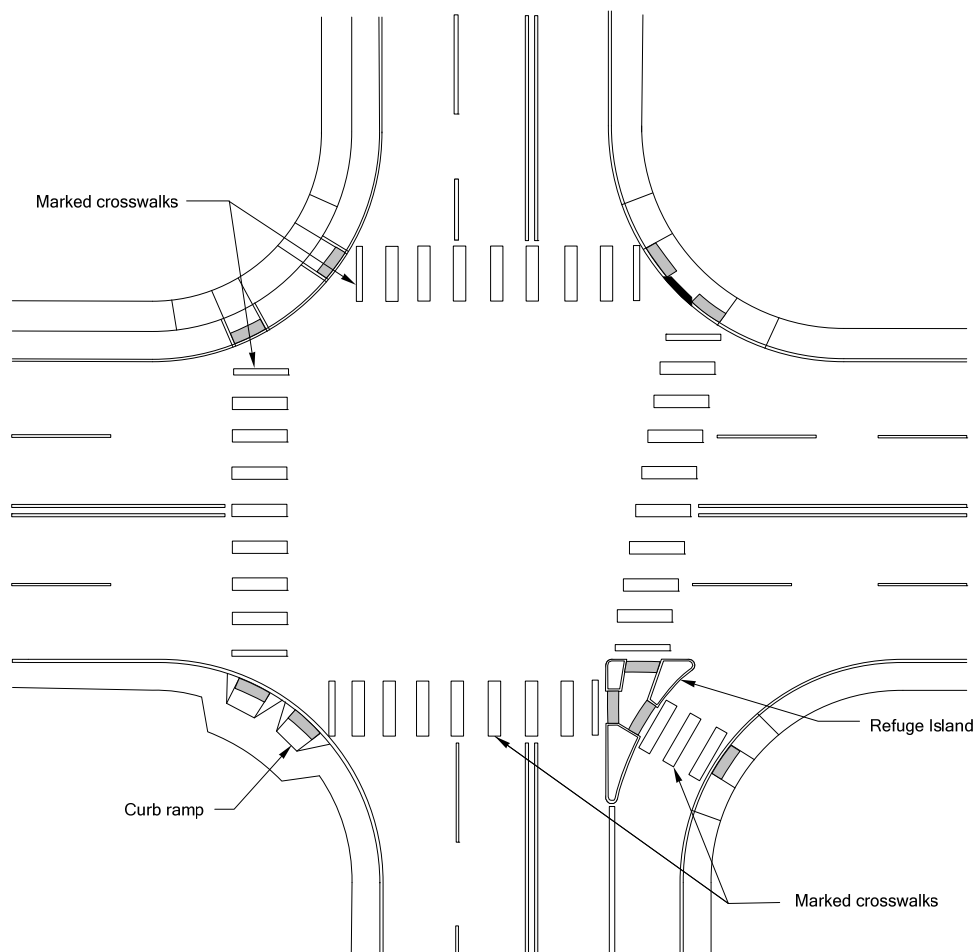

Marked Pedestrian Crossing
Exhibit 1510-15

(c) Closed Crossings

Pedestrian crossings at grade are permitted along the length of most highways. Pedestrian crossing on all legs of an intersection is also permitted, whether a crosswalk is marked or unmarked. An illegal pedestrian crossing only occurs when signs prohibit a particular crossing at an intersection or the crossing occurs between two adjacent signalized intersections (RCW 46.61.240).

To meet ADA requirements at any given crossing, equal access to cross the highway shall be provided to all pedestrians unless the pedestrian crossing is prohibited to all pedestrians. Consult with the region Traffic Office when considering a prohibited crossing. Also:

- Provide an accessible alternative to the closed crossing.
 - Make each side of the closed crossing inaccessible to all pedestrians.
 - Install signs and a treatment that is detectable by vision-impaired persons who navigate with a cane, restricting all pedestrians from crossing at that location.
- An example of a closed pedestrian crossing is shown in Exhibit 1510-16.

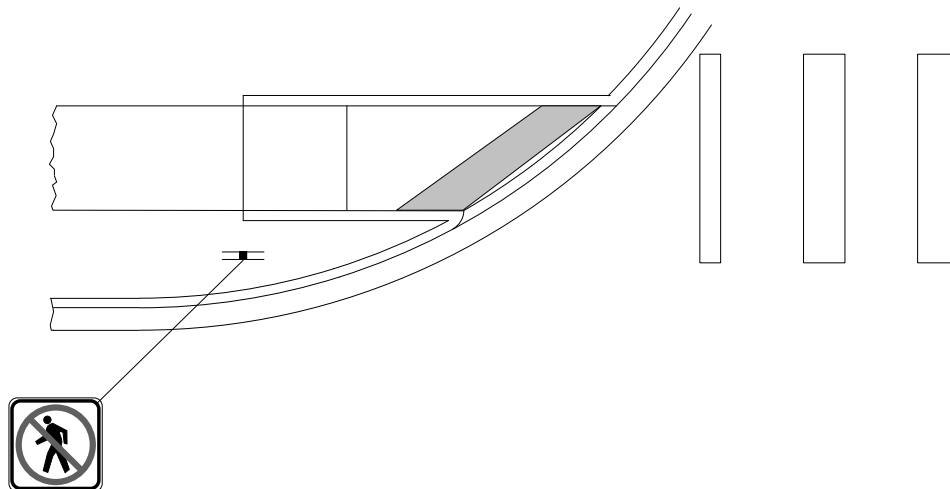

Note: See the *Standard Plans* for additional details.

Example of Closed Pedestrian Crossing

Exhibit 1510-16

(3) Midblock Crosswalks

On roadways with pedestrian crossing traffic caused by nearby pedestrian generators, a midblock crossing may be an appropriate design. (See 1510.10(2) for crosswalk criteria and Exhibit 1510-28 for marked crosswalk recommendations at unsignalized intersections.)

Conditions that might favor a midblock crossing include the following:

- Significant pedestrian crossing demand.
- Pedestrians fail to recognize the best or safest place to cross along a highway and it is advisable to delineate the optimal location.
- The adjacent land use creates high concentrations of pedestrians needing to cross the highway at that location.

- The proposed crossing can concentrate or channel multiple pedestrian crossings to a single location.
- The crossing is at an approved school crossing on a school walk route.
- There is adequate sight distance for motorists and pedestrians.
- It is farther than 300 feet from an existing intersection.
- Speeds are less than 40 mph.

To meet the accessibility criteria, the pedestrian access route in the crosswalk at a midblock crossing may have a cross slope that matches the grade of the roadway. Note that the installation of a midblock pedestrian crossing on a state highway is a design deviation that requires ASDE approval and documentation. An example of a midblock crossing is shown in Exhibit 1510-17.



Midblock Pedestrian Crossing

Exhibit 1510-17

(4) Sight Distance at Crosswalks

When locating crosswalks at intersections, it is important to evaluate the sight lines between pedestrians and motorists. Shrubbery, signs, parked cars, and other roadside elements can block motorists' and pedestrians' views of one another. Exhibit 1510-18 illustrates these sight distance concerns.

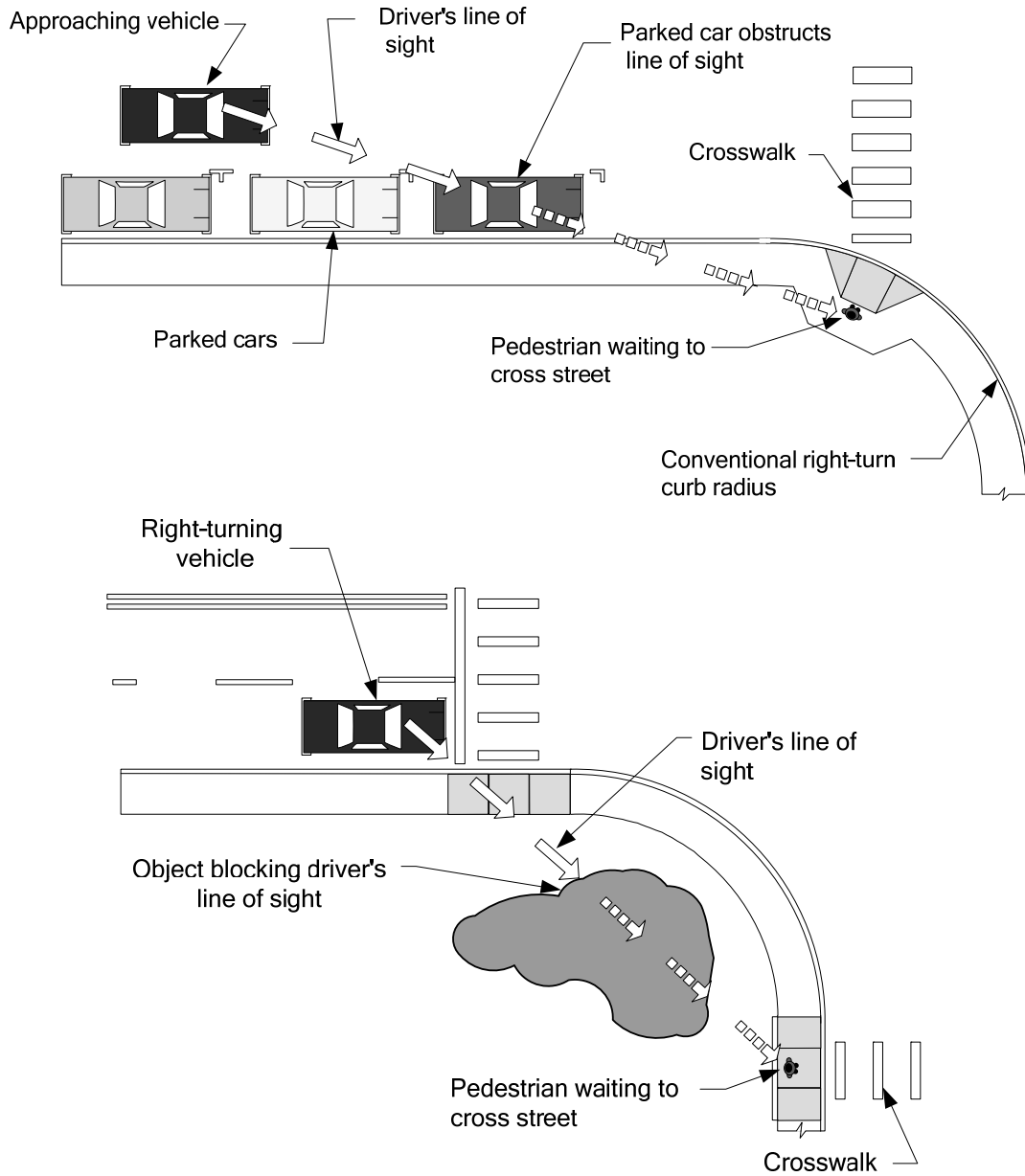

Obstructed Line of Sight at Intersection

Exhibit 1510-18

(5) Curb Extensions

Curb extensions are traffic calming measures that may improve sight distance and reduce pedestrian crossing times, which limits pedestrian exposure. Installing a curb extension can help reduce the sight distance problem with parked cars that limit driver/pedestrian visibility. Curb extensions may allow for better curb ramp design as well as provide more space for pedestrians. Curb extensions are not an option on streets with high-speed traffic or without on-street parking because drivers would be confronted with sudden changes in roadway width.

Extend the curb no farther than the width of the parking lane. (See Chapter 1140 for shoulder width guidance.) Consider an approach nose and low-level landscaping that does not create a sight obstruction. At intersections with traffic signals, the curb extensions can be used to reduce pedestrian signal timing. Examples of sidewalk curb extensions are shown in Exhibits 1510-19 and 1510-20.

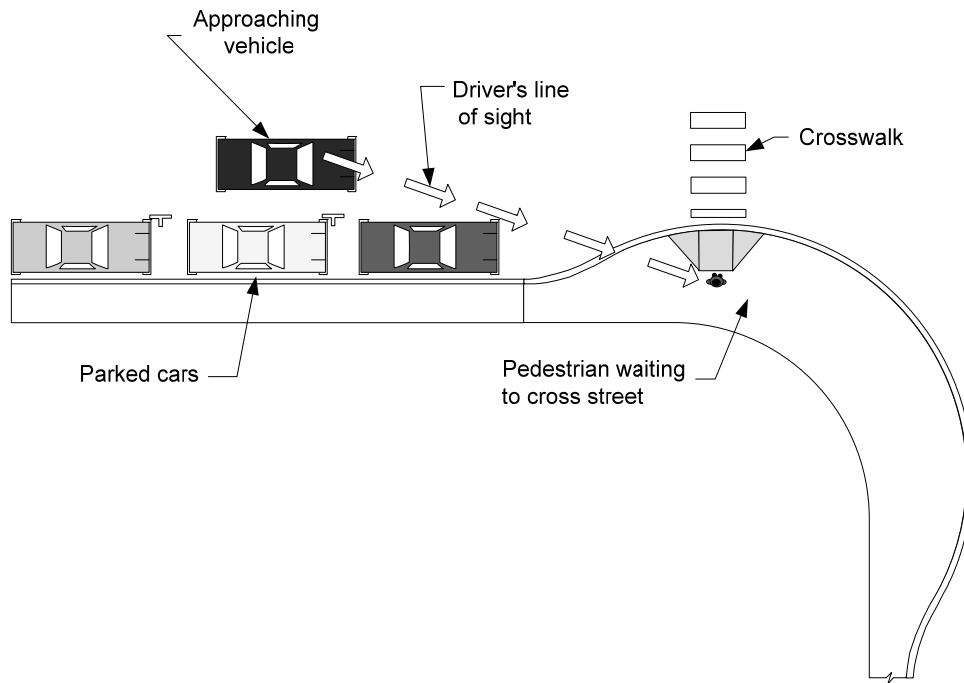

Improved Line of Sight at Intersection

Exhibit 1510-19



Curb Extension Examples

Exhibit 1510-20

The right-turn path of the design vehicle is a critical element in determining the size and shape of the curb extension. Sidewalk curb extensions tend to restrict the width of the roadway and can make right turns difficult for large trucks. Ensure the geometry of the curb extension is compatible with the turn path for the design vehicle selected.

Avoid interrupting bicycle traffic with curb extensions.

Do not use curb extensions on state highways when:

- The design vehicle (see Chapter 1310) encroaches on curbs, opposing lanes, or same-direction lanes, and mountable curbs or other solutions will not improve the circumstances.
- On-street parking is not provided/allowed.
- The posted speed is above 35 mph.

Plantings that do not obstruct the vision of pedestrians or drivers may be used within curb extension areas, as shown in Exhibit 1510-20. Take into account motorist and pedestrian visibility and Design Clear Zone guidelines (see Chapter 1600).

1510.11 Raised Medians/Traffic Islands

Wide multilane streets are often difficult for pedestrians to cross, particularly when there are insufficient gaps in vehicular traffic because of heavy volumes. Consider raised medians and traffic islands with a pedestrian refuge area (see Exhibit 1510-21) on roadways with the following conditions:

- Two-way arterial with intermediate to high speeds (35 mph or greater), moderate to high average daily traffic (ADT), and high pedestrian volumes.
- Significant pedestrian collision history.
- Near a school or other community center.
- Crossing distance exceeds 30 feet.
- Complex or irregularly shaped intersections.

A traffic island used for channelized right-turn slip lanes can provide a pedestrian refuge, but the slip lane may promote faster turning speeds. Minimize the turning radius of the slip lane to keep speeds as low as feasible. To reduce conflicts, keep the slip lane as narrow as practicable and design a crosswalk alignment that is at a right angle to the face of curb. (See Chapters 1310 for turn lanes, 1360 for interchange ramps, and 1320 for pedestrian accommodations in roundabouts.)

The pedestrian access route through a raised median or traffic island can be either raised with curb ramps or a cut-through type (see Exhibit 1510-21). Curb ramps in medians and islands can add difficulty to the crossing for some users. The curbed edges of cut-throughs can be useful cues to the visually impaired in determining the direction of a crossing, especially on an angled route through a median or island.

(1) Accessibility Criteria for Raised Medians and Traffic Islands

There are many design considerations when deciding whether to ramp up to the median or island grade or create a cut-through median or island matching the roadway grade. These considerations may include profile grade and cross slope of the road, drainage patterns, and the length or width of the median or island.

The following accessibility criteria apply:

- Each raised median or traffic island shall contain a pedestrian access route connecting to each crosswalk (see 1510.07).
- Provide a passing space at least 5 feet wide for a distance of at least 5 feet for each pedestrian access route in a raised median or on a traffic island (see Exhibit 1510-21).

Note: It is recommended that cut-throughs be designed to have a minimum width of 5 feet to ensure a passing space is provided.

- Medians and pedestrian refuge islands shall be 6 feet minimum in length in the direction of pedestrian travel.
- Detectable warning surfaces are to be separated by 2 feet minimum length in the direction of pedestrian travel.
- Detectable warning surfaces are located at each curb ramp or roadway entrance of a pedestrian access route through a raised median or traffic island. The detectable warning surface shall be located at the back of the curb (see Exhibit 1510-21).
- When the pedestrian access route of a shared-use path goes through a raised median or traffic island, the width shall be the same as the width of the shared-use path (see Chapter 1515).



Island Cut-Through

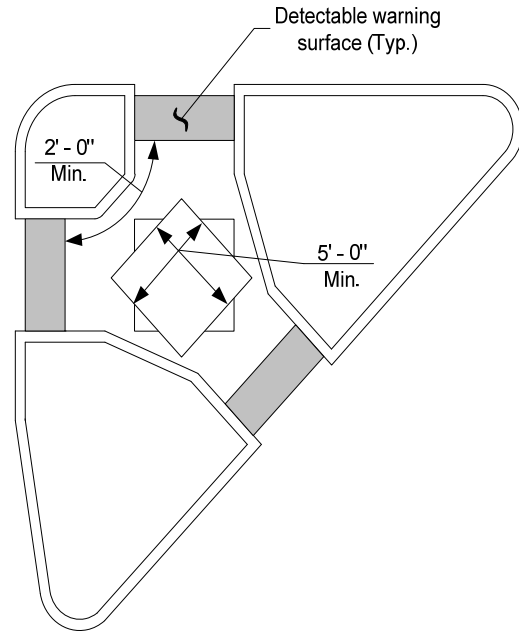

Island Cut-Through

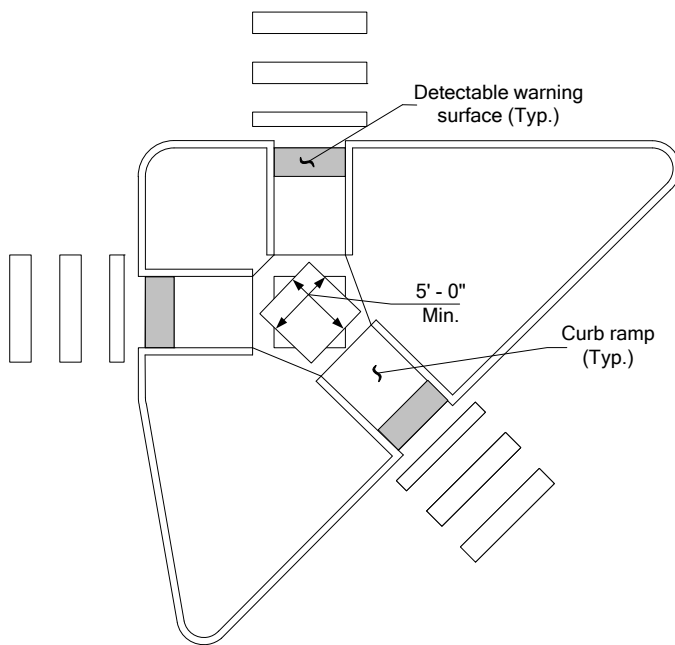

Raised Traffic Island With Curb Ramps

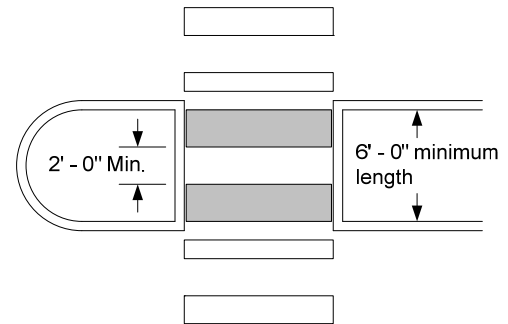

Median Island Cut-Through (full width shown)
(See 1510.11(1) for minimum accessibility criteria.)

See the *Standard Plans* for details.

Raised Islands With Curb Ramps and Pedestrian Cut-Throughs

Exhibit 1510-21

1510.12 Pedestrian Push Buttons at Signals

When designing pedestrian signals, consider the needs of all pedestrians, including older pedestrians and pedestrians with disabilities who might walk at a significantly slower pace than the average pedestrian. Determine whether there are pedestrian generators in the project vicinity that might attract older people and pedestrians with disabilities, and adjust signal timing accordingly. Include accessible pedestrian pushbuttons and countdown pedestrian displays at all locations. Consult with region and city maintenance personnel regarding maintenance requirements for these devices.

- Locate pedestrian push buttons in accordance with the most current edition of the *Public Rights-of-Way Accessibility Guidelines* (PROWAG) and the MUTCD.
- Clearly identify which crossing is controlled by the push button.
- Provide a level clear space (maximum 2% running and cross slopes, 4 feet minimum length by 2 feet 6 inches minimum width) within reach range at each push button for wheelchair users. The level clear space must be connected to the crosswalk it serves by a pedestrian access route.
- Mount push button at an approximate height of 3 feet 6 inches (but no greater than 3 feet 10 inches) above, and a maximum horizontal distance of 2 feet from the level clear space surface.

(1) Accessible Pedestrian Signals (APS)

At all locations where pedestrian signals are newly installed, replaced, or significantly modified, the installation of accessible pedestrian signals (APS) and countdown pedestrian displays is required. (Note: Simply moving existing pedestrian push buttons to satellite poles to improve accessibility is not by itself considered a significant modification of the pedestrian signal.) When APS and countdown pedestrian display improvements are made, they shall be made for all locations associated with the system being improved. APS includes audible and vibrotactile indications of the WALK interval. Installation of these devices may require improvements to existing sidewalks and curb ramps to ensure ADA compliance.

Refer to the MUTCD and the most current edition of the PROWAG for design requirements. Also, consult with HQ Traffic Operations, the HQ Design Office, and region and city maintenance personnel for current equipment specifications and additional design and maintenance requirements.

1510.13 At-Grade Railroad Crossings

The design of pedestrian facilities across railroad tracks (see Exhibit 1510-22) often presents challenges due to the conflicting needs of pedestrians and trains. In particular, the flangeway gap for trains to traverse a crossing surface may create a significant obstacle for a person who uses a wheelchair, crutches, or walking aids for mobility. Whenever practicable, make crossings perpendicular to the tracks in order to minimize potential problems related to flangeway gaps. Crossing surfaces may be constructed of timber planking, rubberized materials, or concrete. Concrete materials generally provide the smoothest and most durable crossing surfaces. When detectable warning surfaces are used at railroad crossings, place them according to the MUTCD stop line placement criteria.



Undesirable



Recommended

Pedestrian Railroad Crossings

Exhibit 1510-22

There are a number of railroad crossing warning devices (see Exhibit 1510-23) intended specifically for pedestrian facilities (see the MUTCD). When selecting warning devices, take into account such factors as train and pedestrian volumes, train speeds, available sight distance, number of tracks, and other site-specific characteristics. Coordinate with the HQ Design Office Railroad Liaison early in the design process so that all relevant factors are considered and an agreement may be reached regarding the design of warning devices and crossing surfaces.



Pedestrian Railroad Warning Device

Exhibit 1510-23

Except for crossings located within the limits of first-class cities,* the Washington Utilities and Transportation Commission (WUTC) approves proposals for any new railroad at-grade crossings or changes to warning devices or geometry at existing crossings. Additionally, any project that requires the railroad to perform work such as installation of warning devices or crossing surfaces must obtain a railroad construction and maintenance agreement. Contact the HQ Design Office Railroad Liaison to coordinate with both WUTC and the railroad company.

*RCW 35.22.010: A first class city is a city with a population of ten thousand or more at the time of its organization or reorganization that has a charter adopted under Article XI, section 10, of the state Constitution.

There are few first-class cities in the state of Washington. Consult with the HQ Design Office Railroad Liaison.

1510.14 Pedestrian Grade Separations (Structures)

On the approach to a bridge that has a raised sidewalk, provide a ramp that transitions to the sidewalk from the paved shoulder. A ramp that transitions from a paved shoulder to a sidewalk on a bridge is to have a slope of 5% maximum and be constructed of asphalt or cement concrete. In addition to aiding pedestrian access, the ramp also serves as a roadside safety feature to mitigate the raised, blunt end of the concrete sidewalk. If a pedestrian circulation path (such as a raised sidewalk or shared-use path) is located near the bridge, consider eliminating the gap between the bridge sidewalk and the pedestrian circulation path by extending the bridge sidewalk to match into the nearby pedestrian circulation path.

At underpasses where pedestrians are allowed, it is desirable to provide sidewalks and to maintain the full shoulder width. When bridge columns are placed on either side of the roadway, it is preferred to place the walkway between the roadway and the columns for pedestrian visibility and security. Provide adequate illumination and drainage for pedestrian safety and comfort.

In cases where there is a pedestrian collision history, and the roadway cannot be redesigned to accommodate pedestrians at grade, planners should consider providing a grade-separated pedestrian structure (see Exhibits 1510-24 and 1510-25). When considering a pedestrian grade-separation structure, determine whether the conditions that require the crossing are permanent. If there is likelihood that pedestrians will not use a grade separation, consider less-costly solutions.

Locate the grade-separated crossing where pedestrians are most likely to cross the roadway. A crossing might not be used if the pedestrian is required to deviate significantly from a more direct route.

It is sometimes necessary to install fencing or other physical barriers to channel the pedestrians to the structure and reduce the possibility of undesired at-grade crossings. Note: The HQ Bridge and Structures Office is responsible for the design of pedestrian structures.

Consider a grade-separated crossing where:

- There is moderate-to-high pedestrian demand to cross a freeway or expressway.
- There are large numbers of young children, particularly on school routes, who regularly cross high-speed or high-volume roadways.
- The traffic conflicts that would be encountered by pedestrians are considered unacceptable (such as on wide streets with high pedestrian volumes combined with high-speed traffic).
- There are documented collisions or close calls involving pedestrians and vehicles.

- One or more of the conditions stated above exists in conjunction with a well-defined pedestrian origin and destination (such as a residential neighborhood across a busy street from a school).

(1) Pedestrian Bridges

Pedestrian grade-separation bridges (see Exhibit 1510-24) are more effective when the roadway is below the natural ground line, as in a cut section. Elevated grade separations in cut sections, where pedestrians climb stairs or use long approach ramps, tend to be underused. Pedestrian bridges need adequate right of way to accommodate accessible ramp approaches leading up to and off of the structure. The bridge structure must comply with ADA requirements and meet the accessibility criteria for either a pedestrian circulation path (if the grade is 5% or less) or an access ramp (if the grade is greater than 5% but less than or equal to 8.3%), and must include a pedestrian access route. (See 1510.06 and 1510.07 for pedestrian circulation path and pedestrian access route accessibility criteria; see 1510.15(2) for access ramp accessibility criteria.)

For the minimum vertical clearance from the bottom of the pedestrian structure to the roadway beneath, see Chapter 720. The height of the structure can affect the length of the pedestrian ramp approaches to the structure. When access ramps are not feasible, provide both elevators and stairways.

Provide railings on pedestrian bridges. Protective screening is sometimes desirable to deter pedestrians from throwing objects from an overhead pedestrian structure (see Chapter 720).

The minimum clear width for pedestrian bridges is 8 feet. Consider a clear width of 14 feet where a pedestrian bridge is enclosed or shared with bicycles or equestrians.



Pedestrian Bridges

Exhibit 1510-24

(2) Pedestrian Tunnels

Tunnels are an effective method of providing crossings for roadways located in embankment sections. Well-designed tunnels can be a desirable crossing for pedestrians. When feasible, design the tunnel with a nearly level profile to provide an unobstructed line of sight from portal to portal (see Exhibit 1510-25). People may be reluctant to enter a tunnel with a depressed profile because they are unable to see whether the tunnel is occupied. Police officers also have difficulty patrolling depressed profile tunnels.

Provide vandal-resistant daytime and nighttime illumination within the pedestrian tunnel. Installing gloss-finished tile walls and ceilings can enhance light levels within the tunnel. The minimum overhead clearance for a pedestrian tunnel is 10 feet. The minimum width for a pedestrian tunnel is 12 feet. Consider a tunnel width between 14 and 18 feet depending on usage and the length of the tunnel.



Pedestrian Tunnel

Exhibit 1510-25

Pedestrian tunnels need adequate right of way to accommodate accessible approaches leading to the tunnel structure. The tunnel structure must comply with ADA requirements and meet the accessibility criteria for either a pedestrian circulation path (if the grade is less than or equal to 5%) or an access ramp (if the grade is greater than 5% and less than or equal to 8.3%), and must include a pedestrian access route. (See 1510.06 and 1510.07 for pedestrian circulation path and pedestrian access route accessibility criteria; see 1510.15(2) for access ramp accessibility criteria.)

1510.15 Other Pedestrian Facilities

(1) Transit Stops and School Bus Stops

The location of transit stops is an important element in providing appropriate pedestrian facilities. (Coordinate with the local transit provider.) Newly constructed transit stops must conform to ADA requirements (see Chapter 1430). Design newly constructed transit stops so they are accessible from the sidewalk or paved shoulder. A transit stop on one side of a street usually has a counterpart on the opposite side because transit routes normally function in both directions on the same roadway. Provide adequate crossing facilities for pedestrians.

When locating a transit stop, consider transit ridership and land use demand for the stop. Also, take into account compatibility with the following roadway/traffic characteristics:

- ADT
- Traffic speed
- Crossing distance
- Collision history
- Sight distance

- Connectivity to a pedestrian access route
- Traffic generator density

If any of these suggests an undesirable location for a pedestrian crossing, consider a controlled crossing or another location for the transit stop.

When analyzing a transit stop location with high pedestrian collision rates, take into account the presence of nearby transit stops and opportunities for pedestrians to reasonably safely cross the street. At-grade midblock pedestrian crossings may be effective at transit stop locations on roadways with lower vehicular volumes. Pedestrian grade separations are appropriate at midblock locations when vehicular traffic volumes prohibit pedestrian crossings at grade. (See Exhibit 1510-28 for recommendations for marked crosswalks at unsignalized intersections.)

School bus stops are typically adjacent to sidewalks in urban areas and along shoulders in rural areas. Determine the number of children using the stop and provide a waiting area that allows the children to wait for the bus. Coordinate with the local school district. Because of their smaller size, children might be difficult for motorists to see at crossings or stops. Determine whether utility poles, vegetation, and other roadside features interfere with the motorist's ability to see the children. When necessary, remove or relocate the obstructions or move the bus stop. Parked vehicles can also block visibility, and parking prohibitions might be advisable near the bus stop. Coordinate transit and school bus stop locations with the region Traffic Office.

(2) Access Ramps Serving Transit Stops, Park & Ride Lots, Rest Areas, Buildings, and Other Facilities

An access ramp (see Exhibit 1510-26) provides an accessible pedestrian route from a pedestrian circulation path to a facility such as a transit stop, park & ride lot, rest area, pedestrian overcrossing/undercrossing structure, or building. When the running slope is 5% or less, it can be designed as a pedestrian circulation path that includes a pedestrian access route. When the running slope is greater than 5% to a maximum of 8.3%, it must be designed as an access ramp. (See 1510.06 and 1510.07 for pedestrian circulation path and pedestrian access route accessibility criteria; see 1510.15(2)(a) for access ramp accessibility criteria.)

(a) Accessibility Criteria for Access Ramps

Access ramps are comprised of one or more ramp segments interconnected by level landings. Unless superseded by the following specific accessibility requirements for access ramps, the accessibility requirements for pedestrian access routes also apply:

- Ramp segments shall have a maximum running slope of 8.3%.
- The cross slope of ramp segments shall be 2% maximum.
- The minimum clear width of ramps is 4 feet; however, it is desirable to match the width of the connecting pedestrian facility.
- The rise for any ramp segment shall be 30 inches maximum.
- A level landing (2% maximum perpendicular and parallel slopes) shall be provided at the top and bottom of each access ramp segment.
- An access ramp landing's clear width shall be at least as wide as the widest ramp segment leading to the landing.

- An access ramp landing's length shall be 5 feet minimum.
- Access ramps that change direction between ramp segments at landings shall have a level landing 5 feet minimum width by 5 feet minimum length.
- Provide ADA-compliant handrails on all access ramp segments with a rise greater than 6 inches (see 1510.15(3) for handrail accessibility criteria).

Provide edge protection complying with one of the two following options on each side of access ramp segments:

- The surface of the ramp segment and landing shall extend 12 inches minimum beyond the inside face of the handrail.
- A curb or barrier shall be provided that does not allow the passage of a 4-inch-diameter sphere, where any portion of the sphere is within 4 inches of the ramp/landing surface.



Access Ramp With Accessible Handrails

Exhibit 1510-26

(3) Other Pedestrian Facilities, Features, and Elements

This chapter covers the accessibility criteria for the most commonly encountered pedestrian design elements in the public right of way. However, there are ADA requirements that apply to any feature or element for pedestrian use, such as accessible handrails, doorways, elevators, stairs, call boxes, and drinking fountains. For accessibility criteria for less commonly encountered pedestrian design elements, consult the applicable federal guidance document(s) listed in 1510.02(2).

1510.16 Illumination and Signing

In Washington State, the highest number of collisions between vehicles and pedestrians tends to occur during November through February, when there is poor visibility and fewer daylight hours. Illumination of pedestrian crossings and other walkways is an important design consideration because lighting has a major impact on a pedestrian's safety and sense of security. Illumination provided solely for vehicular traffic is not always effective in lighting parallel walkways for pedestrians. Consider pedestrian-level (mounted at a lower level) lighting for pedestrian circulation paths, intersections, and other pedestrian crossing areas with high nighttime pedestrian activity, such as shopping districts, transit stops, schools, community centers, and other major pedestrian generators or areas with a history of pedestrian collisions. (See Chapter 1040 for design guidance on illumination and Chapter 1020 and the MUTCD for pedestrian-related signing.)

1510.17 Work Zone Pedestrian Accommodation

Providing access and mobility for pedestrians through and around work zones (see Exhibit 1510-27) is an important design concern, and it must be addressed in the temporary traffic control plans if the project occurs in a location accessible to pedestrians. The designer must determine pedestrian needs in the proposed work zone during the public input process and through field visits.

In work zones:

- Separate pedestrians from conflicts with work zone equipment and operations.
- Separate pedestrians from traffic moving through or around the work zone.
- Provide pedestrians with alternate routes that have accessible and convenient travel paths that duplicate, as closely as feasible, the characteristics of the existing pedestrian facilities.

Provide walkways that are clearly marked and pedestrian barriers that are continuous, rigid, and detectable to vision-impaired persons who navigate with a cane. Also, keep:

- The pedestrian head space clear.
- Walkways free from pedestrian hazards such as holes, debris, and abrupt changes in grade or terrain.
- Access along sidewalks clear of obstructions such as construction traffic control signs.
- A minimum clear width path throughout: 4 feet for pedestrians or 10 feet for pedestrians and bicyclists.

Temporary pedestrian facilities within the work zone must meet accessibility criteria to the maximum extent feasible. (See 1510.06 and 1510.07 for pedestrian circulation path and pedestrian access route accessibility criteria.)

Consider the use of flaggers if pedestrian generators such as schools are in the work zone vicinity. Consider spotters who are prepared to help pedestrians through the work zone.

Provide for advance public notification of sidewalk closures in the contract special provisions and plans.

Where transit stops are affected or relocated because of work activity, provide an accessible route to temporary transit stops.

For further information and guidance on work zone pedestrian accommodation, see Chapter 1010, the most current edition of the PROWAG, and the MUTCD.



Meets ADA requirements



Does not meet ADA requirements

Work Zones and Pedestrian Facilities

Exhibit 1510-27

1510.18 Documentation

For the list of documents required to be preserved in the Design Documentation Package and the Project File, see the Design Documentation Checklist:

📄 www.wsdot.wa.gov/design/projectdev/

Traffic Volume (ADT)	Posted Speed	Roadway Type			
		2 lanes	2 lanes, raised median ^[1]	4 lanes, raised median ^[1]	6 lanes, raised median ^[1]
Less than or equal to 9,000	30 mph and lower	Marked crosswalk	Marked crosswalk	Additional enhancement	
	35 mph to 40 mph	Marked crosswalk	Marked crosswalk	Additional enhancement	
	45 mph and higher	Additional enhancement	Additional enhancement	Active enhancement	
9,000 to 15,000	30 mph and lower	Marked crosswalk	Marked crosswalk	Additional enhancement	
	35 mph to 40 mph	Marked crosswalk	Marked crosswalk	Additional enhancement	
	45 mph and higher	Additional enhancement	Additional enhancement	Active enhancement	
15,000 to 30,000	30 mph and lower	Additional ^[2] enhancement	Additional enhancement	Additional ^[2] enhancement	Active ^[4] enhancement
	35 mph to 40 mph	Additional ^[2] enhancement	Additional enhancement	Active enhancement	Active ^[4] enhancement
	45 mph and higher	Active ^[5] enhancement	Active enhancement	See note [3]	See note [3]
Greater than 30,000	45 mph and lower	Active ^[5] enhancement	Active enhancement	Pedestrian ^[6] traffic signal	Pedestrian ^[6] traffic signal

Inside city limits where the population exceeds 25,000, coordinate the decision to mark crosswalks with the city. Provide documentation for all marked crosswalks.

For additional considerations that may be appropriate based on site-specific engineering analyses, see 1510.10.

Notes:

- [1] Raised median/traffic island with a cut-through path minimum width of 5 feet and a median width of 6 feet.
- [2] Consider active enhancement treatment for roadways exceeding 20,000 ADT.
- [3] Provide alternate routes for pedestrian crossings, or construct a grade-separated facility.
- [4] Location may be approaching the need for a controlled crossing. A pedestrian signal may be appropriate, based on engineering analysis.
- [5] Raised median/traffic island required.
- [6] Refer to the region Traffic Engineer for approval and design of a pedestrian traffic signal. Midblock pedestrian crossings are deviations that require ASDE approval.

Minimum Guidelines (additive for each level):

“Marked crosswalk”

- Marked/signed in accordance w/MUTCD (signed @ crossing only)
- Pedestrian-view warning signs
- Illumination

“Additional enhancement”

- Minimum guidelines listed under “Marked crosswalk”
- Stop line in accordance w/MUTCD
- Advance signing in accordance w/MUTCD

“Active enhancement”

- Minimum guidelines listed under “Additional enhancement”
- Pedestrian-actuated flashing beacons for roadway with 4 or more lanes

Crosswalk Marking and Enhancement Guidelines

Exhibit 1510-28

- 1520.01 General
- 1520.02 References
- 1520.03 Definitions
- 1520.04 Facility Selection
- 1520.05 Project Requirements
- 1520.06 Shared-Use Path Design
- 1520.07 Shared Roadway Bicycle Facility Design
- 1520.08 Signed Shared Bicycle Roadway Design
- 1520.09 Bicycle Lane Design
- 1520.10 Documentation

1520.01 General

The Washington State Department of Transportation (WSDOT) encourages bicycle use on its facilities. Bicycle facilities (bike lanes and shared roadways), or improvements for bicycle transportation, are included in the project development and highway programming processes.

This chapter is a guide for designing bicycle facilities within state highway right of way or between the curb lines on city streets designated as state highways when the design matrices (see Chapter 1100) indicate full design level for bicycle and pedestrian design elements. Bike lanes and shared roadways are presented.

When designing facilities outside of state highway right of way or beyond the curb on city streets designated as state highways, use the latest edition of AASHTO's *Guide for the Development of Bicycle Facilities*.

These guidelines apply to normal situations encountered during project development. Unique design problems are resolved on a project-by-project basis using guidance from the region's Bicycle Coordinator or bicycle and pedestrian expert.

1520.02 References

(1) Federal/State Laws and Codes

Americans with Disabilities Act of 1990 (ADA)

23 Code of Federal Regulations (CFR) Part 652, Pedestrian and Bicycle Accommodations and Projects

Revised Code of Washington (RCW), Chapter 35.75, Streets – Bicycles – Paths

<http://apps.leg.wa.gov/rcw/default.aspx?cite=35.75>

RCW 46.04, Definitions

<http://apps.leg.wa.gov/rcw/default.aspx?cite=46.04>

RCW 46.61, Rules of the road

<http://apps.leg.wa.gov/rcw/default.aspx?cite=46.61>

RCW 46.61.710, Mopeds, electric-assisted bicycles – General requirements and operation

<http://apps.leg.wa.gov/rcw/default.aspx?cite=46.61.710>

RCW 47.26.300, Bicycle routes – Legislative declaration

<http://apps.leg.wa.gov/rcw/default.aspx?cite=47.26.300>

(2) Design Guidance

Manual on Uniform Traffic Control Devices for Streets and Highways, USDOT, FHWA; as adopted and modified by Chapter 468-95 WAC “Manual on uniform traffic control devices for streets and highways” (MUTCD)

www.wsdot.wa.gov/publications/manuals/mutcd.htm

Selecting Roadway Design Treatments to Accommodate Bicycles, USDOT, Federal Highway Administration (FHWA), 1994

Standard Plans for Road, Bridge, and Municipal Construction (Standard Plans), M 21-01, WSDOT

www.wsdot.wa.gov/publications/manuals/m21-01.htm

Understanding Flexibility in Transportation Design – Washington, WSDOT, 2005

www.wsdot.wa.gov/research/reports/600/638.1.htm

(3) Supporting Information

A Policy on Geometric Design of Highways and Streets (Green Book), AASHTO, 2004

Guide for the Development of Bicycle Facilities, AASHTO, current edition

1520.03 Definitions

bicycle Any device propelled solely by human power upon which a person or persons may ride, having two tandem wheels, either of which is 16 inches or more in diameter, or three wheels, any one of which is more than 20 inches in diameter.

bicycle route A system of facilities that are used or have a high potential for use by bicyclists or that are designated as such by the jurisdiction having the authority. A series of bicycle facilities may be combined to establish a continuous route and may consist of any or all types of bicycle facilities.

bike lane A portion of a highway or street identified by signs and pavement markings as reserved for bicycle use.

shared roadway A roadway that is open to both bicycle and motor vehicle travel. This may be a new or existing roadway/highway, a street with wide curb lanes, or a road with paved shoulders.

signed shared roadway A shared roadway that has been designated by signing as a route for bicycle use.

shared-use path See Chapter 1515.

wye (Y) connection An intersecting one-way roadway, intersecting at an angle less than 60°, in the general form of a “Y.”

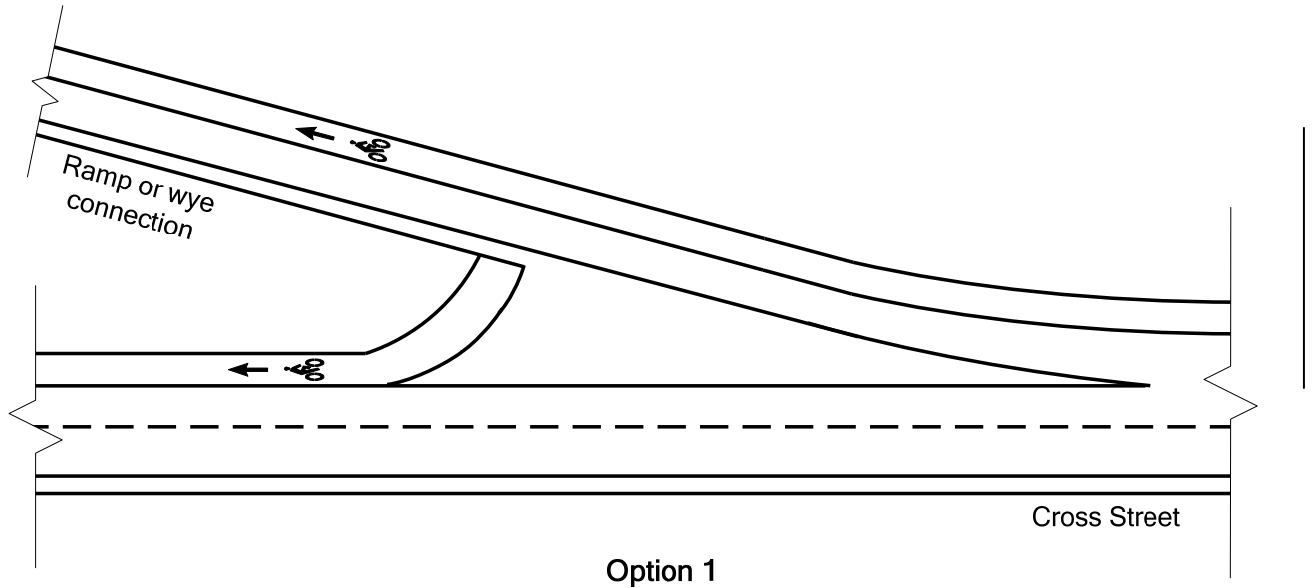

Option 1

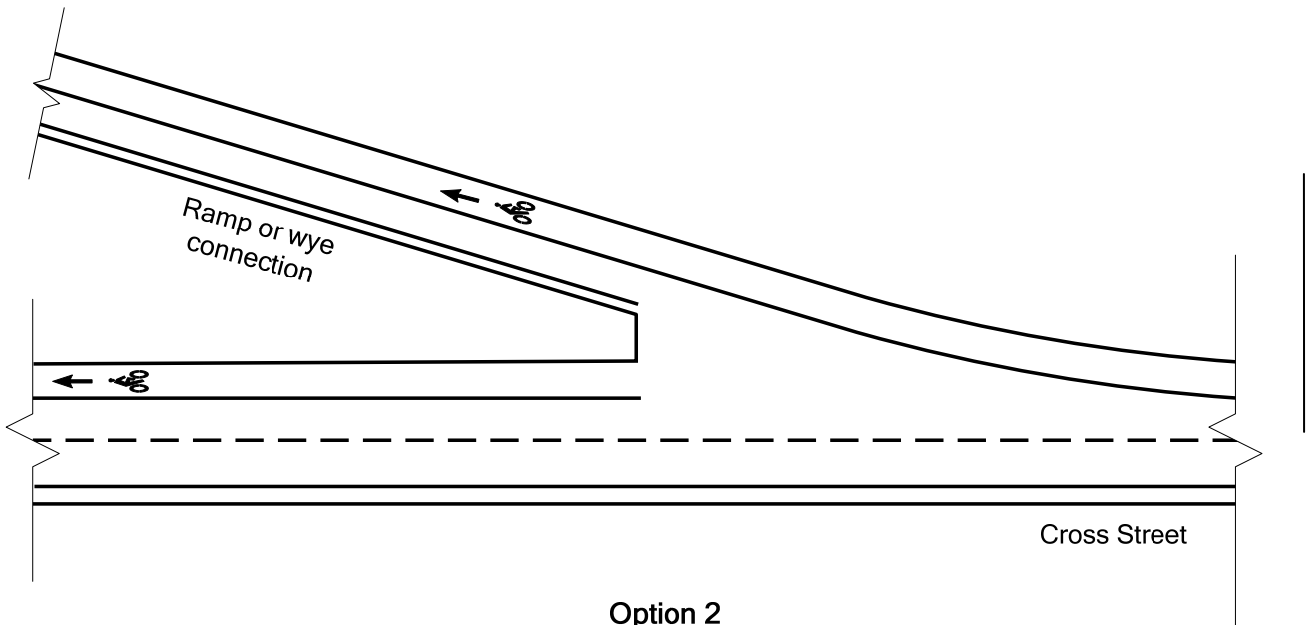

Option 2

Bicycle Crossing of Interchange Ramp
Exhibit 1520-8a

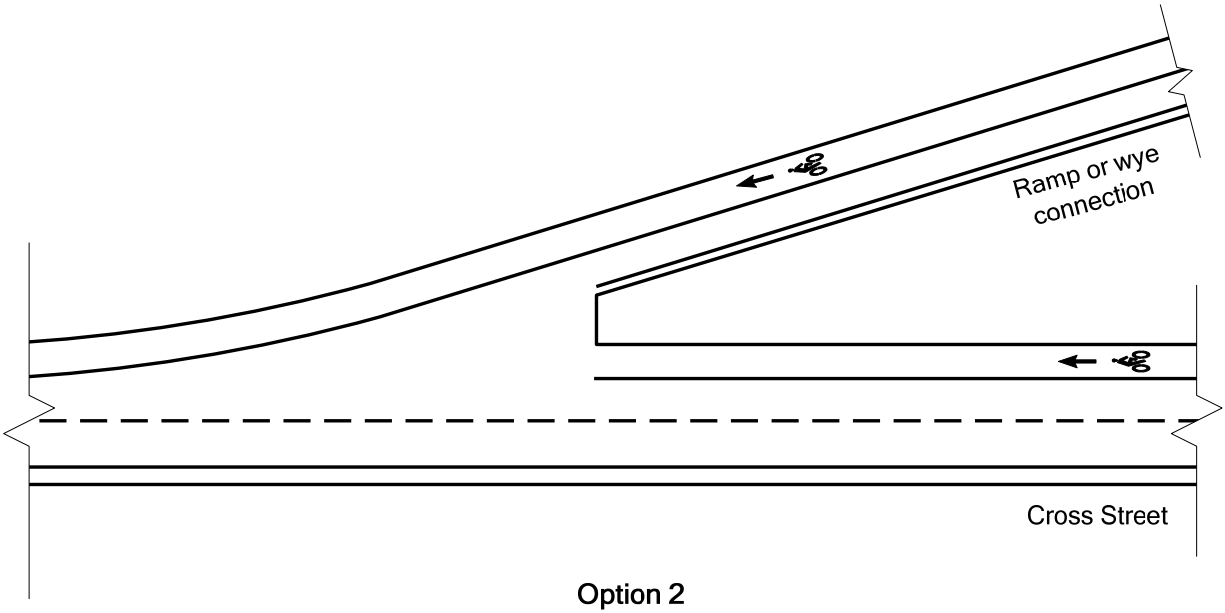
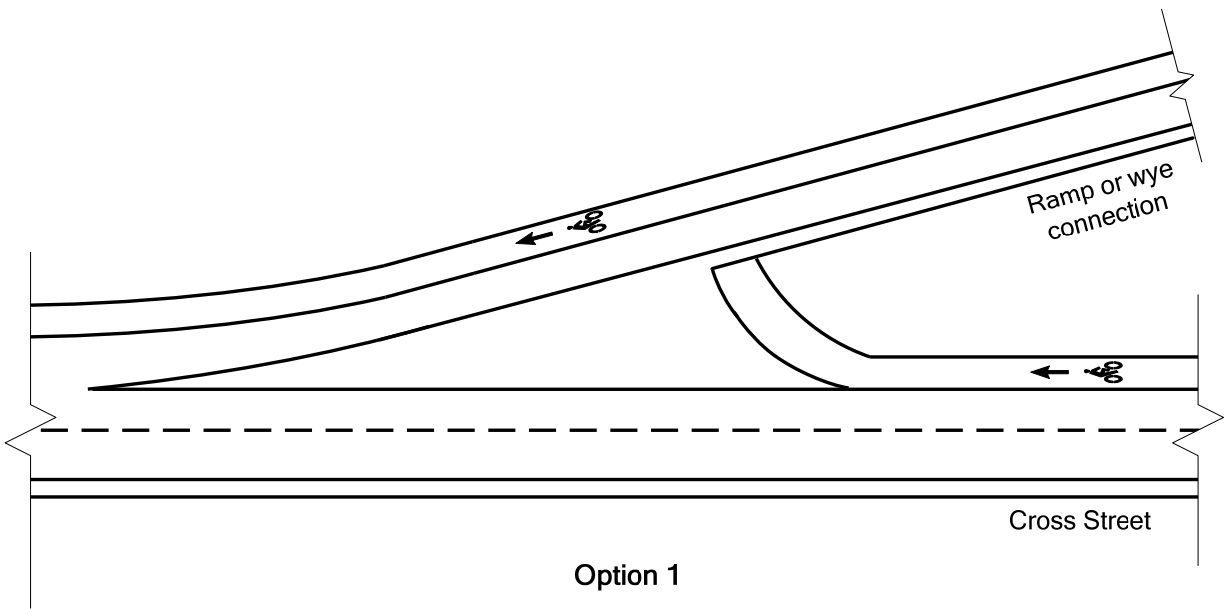

Bicycle Crossing of Interchange Ramp
Exhibit 1520-8b

- 1600.01 General
- 1600.02 References
- 1600.03 Definitions
- 1600.04 Clear Zone
- 1600.05 Features to Be Considered for Mitigation
- 1600.06 Median Considerations
- 1600.07 Other Roadside Safety Features
- 1600.08 Documentation

1600.01 General

Roadside safety addresses the area outside the roadway and is an important component of total highway design. There are numerous reasons why a vehicle leaves the roadway. Regardless of the reason, a forgiving roadside can reduce the seriousness of the consequences of a roadside encroachment. From a safety perspective, the ideal highway has roadsides and median areas that are flat and unobstructed by objects.

Elements such as sideslopes, fixed objects, and water are features that a vehicle might encounter when it leaves the roadway. These features present varying degrees of danger to the vehicle and its occupants. Unfortunately, geography and economics do not always allow ideal highway conditions. The mitigative measures to be taken depend on the probability of a collision occurring, the likely severity, and the available resources.

In order of priority, the mitigative measures the Washington State Department of Transportation (WSDOT) uses are: removal, relocation, reduction of impact severity (using breakaway features or making it traversable), and shielding with a traffic barrier. Consider cost (initial and life cycle costs) and maintenance needs in addition to collision severity when selecting a mitigative measure. Use traffic barriers when other measures cannot reasonably be accomplished. (See Chapter 1610 for additional information on traffic barriers.)

1600.02 References

(1) Federal/State Laws and Codes

Revised Code of Washington (RCW) 47.24.020(2), Jurisdiction, control

RCW 47.32.130, Dangerous objects and structures as nuisances

(2) Design Guidance

Local Agency Guidelines (City and County Design Standards), M 36-63, WSDOT

Roadside Design Guide, AASHTO, 2006

Roadside Manual, M 25-30, WSDOT

Standard Plans for Road, Bridge, and Municipal Construction (Standard Plans), M 21-01, WSDOT

(3) Supporting Information

A Policy on Geometric Design of Highways and Streets (Green Book), AASHTO, 2004

1600.03 Definitions

ADT The average daily traffic for the design year under consideration.

backslope A sideslope that goes up as the distance increases from the roadway (cut slopes).

clear run-out area The area beyond the toe of a nonrecoverable slope available for use by an errant vehicle.

clear zone The total roadside border area, available for use by errant vehicles, starting at the edge of the traveled way and oriented from the outside or inside shoulder (in median applications) as applicable. This area may consist of a shoulder, a recoverable slope, a nonrecoverable slope, and/or a clear run-out area. The clear zone cannot contain a critical fill slope, fixed objects, or water deeper than 2 feet.

critical fill slope A slope on which a vehicle is likely to overturn. Slopes steeper than 3H:1V are considered critical fill slopes.

Design Clear Zone The minimum clear zone target value used in highway design.

foreslope A sideslope that goes down as the distance increases from the roadway (fill slopes and ditch inslopes).

fixed feature (object to be mitigated) A fixed object, a side slope, or water that, when struck, can result in impact forces on a vehicle's occupants that may result in injury or place the occupants in a situation that has a high likelihood of injury. A fixed feature can be either constructed or natural.

nonrecoverable slope A slope on which an errant vehicle might continue until it reaches the bottom, without having the ability to recover control. Fill slopes steeper than 4H:1V, but not steeper than 3H:1V, are considered nonrecoverable.

recoverable slope A slope on which the driver of an errant vehicle can regain control of the vehicle. Slopes of 4H:1V or flatter are considered recoverable.

recovery area The minimum target value used in highway design when a fill slope between 4H:1V and 3H:1V starts within the Design Clear Zone.

traffic barrier A longitudinal barrier, including bridge rail or an impact attenuator, used to redirect vehicles from fixed features located within an established Design Clear Zone, help mitigate median crossovers, reduce the potential for errant vehicles to travel over the side of a bridge structure, or (occasionally) protect workers, pedestrians, or bicyclists from vehicular traffic.

traveled way The portion of the roadway intended for the movement of vehicles, exclusive of shoulders and lanes for parking, turning, and storage for turning.

rumble strips Rumble strips are grooves or rows of raised pavement markers placed perpendicular to the direction of travel to alert inattentive drivers.

1600.04 Clear Zone

A clear roadside border area is a primary consideration when analyzing potential roadside and median features (as defined in 1600.05). The intent is to provide as much clear, traversable area for a vehicle to recover as practicable. The Design Clear Zone is used to evaluate the adequacy of the existing clear area and proposed modifications of the roadside. When considering the placement of new objects along the roadside or median, evaluate the potential for impacts and try to select locations with the least likelihood of an impact by an errant vehicle.

In situations where the Design Clear Zone is beyond WSDOT right of way, evaluate options on a case-by-case basis. Consider the nature of the objects within the Design Clear Zone, the roadway geometry, traffic volume, and crash history. Coordinate with adjacent property owners when proposed options include any work beyond WSDOT right of way. At a minimum, provide clear zone to the limits of the WSDOT right of way.

(1) Design Clear Zone on Limited Access State Highways and Other State Highways Outside Incorporated Cities and Towns

Evaluate the Design Clear Zone when the Clear Zone column on the design matrices (see Chapter 1100) indicates evaluate upgrade (EU) or Full Design Level (F) or when considering the placement of a new fixed object on the roadside or median. Use the Design Clear Zone Inventory form (Exhibit 1600-2) to identify potential features to be mitigated and propose corrective actions.

Guidance for establishing the Design Clear Zone for highways outside incorporated cities is provided in Exhibit 1600-1. This guidance also applies to limited access facilities within the city limits. Providing a clear recovery area that is consistent with this guidance does not require any additional documentation. However, there might be situations where it is not practicable to provide these recommended distances. In these situations, document the decision as an evaluate upgrade or deviation as discussed in Chapter 300.

For additional Design Clear Zone guidance relating to roundabouts, see Chapter 1320.

While not required, the designer is encouraged to evaluate potential objects to be mitigated even when they are beyond the Design Clear Zone distances.

For state highways that are in an urban environment, but outside an incorporated city, evaluate both median and roadside clear zones as discussed above using Exhibit 1600-1. However, there might be some flexibility in establishing the Design Clear Zone in urbanized areas adjacent to incorporated cities and towns. To achieve this flexibility, an evaluation of the impacts, including safety, aesthetics, the environment, economics, modal needs, and access control, can be used to establish the Design Clear Zone. This discussion, analysis, and agreement must take place early in the consideration of the median and roadside designs. An agreement on the responsibility for these median and roadside sections must be formalized with the city and/or county. Justify the design decision for the selected Design Clear Zone as part of the design approval or a project or corridor analysis (see Chapter 300).

(2) Design Clear Zone Inside Incorporated Cities and Towns

For managed access state highways within an urban area, it is recognized that in many cases it might not be practicable to provide the Design Clear Zone distances shown in Exhibit 1600-1. Roadways within an urban area generally have curbs and sidewalks and might have objects such as trees, poles, benches, trash cans, landscaping, and transit shelters along the roadside.

Because AASHTO's *A Policy on Geometric Design of Highways and Streets* had addressed the concept of operational offset within the discussion of clear zone, some practitioners misinterpreted this offset as providing an adequate clear zone. The 18-inch operational offset beyond the face of curb is a lateral clearance for opening car doors or for truck mirrors. The operational offset is not an acceptable design safety criterion.

(a) Roadside

For managed access state highways, it is the city's responsibility to establish an appropriate Design Clear Zone in accordance with guidance contained in the City and County Design Standards. Document the Design Clear Zone established by the city in the Design Documentation Package.

(b) Median

For managed access state highways with raised medians, the median's Design Clear Zone is evaluated using Exhibit 1600-1. In some instances, a median analysis may show that certain median designs provide significant benefits to overall corridor or project operations. In these cases, flexibility in establishing the Design Clear Zone is appropriate. To achieve this flexibility, an evaluation of the impacts, including safety, aesthetics, the environment, economics, modal needs, and access control, can be used to establish the median clear zone. This discussion, analysis, and agreement must take place early in the consideration of the flexible median design. An agreement on the responsibility for these median sections must be formalized with the city.

Justify the design decision for the selected Design Clear Zone as part of the design approval or a project or corridor analysis (see Chapter 300).

(3) Design Clear Zone and Calculations

The Design Clear Zone guidance provided in Exhibit 1600-1 is a function of the posted speed, sideslope, and traffic volume. There are no distances in the table for 3H:1V fill slopes. Although fill slopes between 4H:1V and 3H:1V are considered traversable if free of fixed objects, these slopes are defined as nonrecoverable slopes. A vehicle might be able to begin recovery on the shoulder, but likely will not be able to further this recovery until reaching a flatter area (4H:1V or flatter) at the toe of the slope. Under these conditions, the Design Clear Zone distance is called a recovery area. The method used to calculate the recovery area and an example are shown in Exhibit 1600-3.

For ditch sections, the following criteria determine the Design Clear Zone:

- (a) For ditch sections with foreslopes 4H:1V or flatter (see Exhibit 1600-4, Case 1, for an example), the Design Clear Zone distance is the greater of the following:
 - The Design Clear Zone distance for a 10H:1V cut section based on speed and the average daily traffic (ADT).
 - A horizontal distance of 5 feet beyond the beginning of the backslope.

When a backslope steeper than 3H:1V continues for a horizontal distance of 5 feet beyond the beginning of the backslope, it is not necessary to use the 10H:1V cut slope criteria.

- (b) For ditch sections with foreslopes steeper than 4H:1V and backslopes steeper than 3H:1V, the Design Clear Zone distance is 10 feet horizontal beyond the beginning of the backslope (see Exhibit 1600-4, Case 2, for an example).
- (c) For ditch sections with foreslopes steeper than 4H:1V and backslopes 3H:1V or flatter, the Design Clear Zone distance is the distance established using the recovery area formula (see Exhibit 1600-3; also see Exhibit 1600-4, Case 3, for an example).

1600.05 Features to Be Considered for Mitigation

There are three general categories of features to be mitigated: sideslopes, fixed objects, and water. The following sections provide guidance for determining when these obstacles present a significant risk to an errant motorist. In addition, several conditions need special consideration:

- Locations with high collision rate histories.
- Locations with pedestrian and bicycle usage. (See Chapters 1510, Pedestrian Design Considerations, 1515, Shared-Use Paths, and 1520, Roadway Bicycle Facilities.)
- Playgrounds, monuments, and other locations with high social or economic value.
- Redirectional land forms, also referred to as earth berms, were installed to mitigate objects located in depressed medians and at roadsides. They were constructed of materials that provided support for a traversing vehicle. With slopes in the range of 2H:1V to 3H:1V, they were intended to redirect errant vehicles. The use of redirectional land forms has been discontinued as a means for mitigating fixed objects. Where redirectional land forms currently exist as mitigation for a fixed object, ensure the feature they were intended to mitigate is removed, relocated, made crashworthy, or shielded with barrier. Landforms may be used to provide a smooth surface at the base of a rock cut slope.

Use of a traffic barrier for features other than those described below requires justification.

(1) Side Slopes

(a) Fill Slopes

Fill slopes can present a risk to an errant vehicle with the degree of severity dependent upon the slope and height of the fill. Providing fill slopes that are 4H:1V or flatter can mitigate this condition. If flattening the slope is not feasible or cost-effective, the installation of a barrier might be appropriate. Exhibit 1600-5 represents a selection procedure used to determine whether a fill side slope constitutes a condition for which a barrier is a cost-effective mitigation. The curves are based on the severity indexes and represent the points where total costs associated with a traffic barrier are equal to the predicted collision cost associated with selected slope heights without traffic barrier. If the ADT and height of fill intersect on the “Barrier Recommended” side of the embankment slope curve, then provide a barrier if flattening the slope is not feasible or cost-effective.

Do not use Exhibit 1600-5 for slope design. Design slopes consistent with guidance in Chapters 1130 and 1230, evaluating designs with clear, traversable slopes before pursuing a barrier option. Also, if Exhibit 1600-5 indicates that barrier is not recommended at an existing slope, that result is not justification for a deviation. For example, if the ADT is 4,000 and the embankment height is 10 feet, barrier might be cost-effective for a 2H:1V slope, but not for a 2.5H:1V slope. This process only addresses the potential risk of exposure to the slope. Obstacles on the slope can compound the condition. Where barrier is not cost-effective, use the recovery area formula to evaluate fixed objects on critical fill slopes less than 10 feet high.

(b) Cut Slopes

A cut slope is usually less of a risk than a traffic barrier. The exception is a rock cut with a rough face that might cause vehicle snagging rather than providing relatively smooth redirection.

Analyze the potential motorist risk and the benefits of treatment of rough rock cuts located within the Design Clear Zone. Conduct an individual investigation for each rock cut or group of rock cuts. A cost-effectiveness analysis that considers the consequences of doing nothing, removal, smoothing of the cut slope, and other viable options to reduce the severity of the condition can be used to determine the appropriate treatment. Some potential options are:

- Graded landform along the base of a rock cut.
- Flexible barrier
- More rigid barrier
- Rumble strips

(2) Fixed Objects

Consider the following objects for mitigation:

- Wooden poles or posts with cross-sectional areas greater than 16 square inches that do not have breakaway features.
- Nonbreakaway steel sign posts.
- Nonbreakaway light standards.
- Trees with a diameter of 4 inches or more, measured at 6 inches above the ground surface.
- Fixed objects extending above the ground surface by more than 4 inches; for example, boulders, concrete bridge rails, signal and electrical cabinets, piers, and retaining walls.
- Existing guardrail that does not conform to current design guidance (see Chapter 1610).
- Drainage items such as culvert and pipe ends.

Mitigate fixed features that exist within the Design Clear Zone when feasible. Although limited in application, there may be situations where removal of an object outside the right of way is appropriate. The possible mitigative measures are listed as follows in order of preference:

- Remove
- Relocate
- Reduce impact severity (using a breakaway feature)
- Shield the object by using longitudinal barrier or impact attenuator

(a) Trees

When evaluating new plantings or existing trees, consider the maximum allowable diameter of 4 inches, measured at 6 inches above the ground when the tree has matured. When removing trees within the Design Clear Zone, complete removal of stumps is preferred. However, to avoid significant disturbance of the roadside vegetation, larger stumps may be mitigated by grinding or cutting them flush to the ground and grading around them. (See the *Roadside Manual* for further guidance on the treatment of disturbed roadside.)

(b) Mailboxes

For mailboxes located within the Design Clear Zone, provide supports and connections as shown in the *Standard Plans*. The height from the ground to the bottom of the mailbox is 3 feet 3 inches. This height may vary from 3 feet 3 inches to 4 feet if requested by the mail carrier. If the desired height is to be different from 3 feet 3 inches, provide the specified height in the contract plans. (See Exhibit 1600-6 for installation guidelines.) Coordinate with homeowners when upgrading mailboxes.

In urban areas where sidewalks are prevalent, contact the postal service to determine the most appropriate mailbox location. Locate mailboxes on limited access highways in accordance with Chapter 530, Limited Access. A turnout, as shown in Exhibit 1600-6, is not needed on limited access highways with shoulders of 6 feet or more where only one mailbox is to be installed. On managed access highways, mailboxes are to be on the right-hand side of the road in the postal carrier's direction of travel. Avoid placing mailboxes along high-speed, high-volume highways. Locate Neighborhood Delivery and Collection Box Units (NDCBUs) outside the Design Clear Zone.

(c) Culvert Ends

Provide a traversable end treatment when the culvert end section or opening is on the roadway sideslope and within the Design Clear Zone. This can be accomplished for small culverts by beveling the end to match the sideslope, with a maximum of 4 inches extending out of the sideslope.

Bars might be needed to provide a traversable opening for larger culverts. Place bars in the plane of the culvert opening in accordance with the *Standard Plans* when:

- Single cross-culvert opening exceeds 40 inches, measured parallel to the direction of travel.
- Multiple cross-culvert openings that exceed 30 inches each, measured parallel to the direction of travel.
- Culvert approximately parallel to the roadway that has an opening exceeding 24 inches, measured perpendicular to the direction of travel.

Bars are permitted where they will not significantly affect the stream hydraulics and where debris drift is minor. Consult the region Maintenance Office to verify these conditions. If debris drift is a concern, consider options to reduce the amount of debris that can enter the pipe (see the *Hydraulics Manual*). Other treatments are extending the culvert to move the end outside the Design Clear Zone or installing a traffic barrier.

(d) Signposts

Whenever possible, locate signs behind existing or planned traffic barrier installations to eliminate the need for breakaway posts. Place them at least 25 feet from the end of the barrier terminal and with the sign face behind the barrier. When barrier is not present, use terrain features to reduce the likelihood of an errant vehicle striking the signposts. Whenever possible, depending on the type of sign and the sign message, adjust the sign location to take advantage of barrier or terrain features. This might reduce collision potential and, possibly, future maintenance costs. (See Chapter 1020 for additional information regarding the placement of signs.)

Signposts with cross-sectional areas greater than 16 square inches that are within the Design Clear Zone and not located behind a barrier are to have breakaway features as shown in the *Standard Plans*.

Sign bridges and cantilever sign supports are designed for placement outside the Design Clear Zone or shielded by barrier.

(e) Traffic Signal Standards/Posts/Supports

Breakaway signal posts generally are not feasible or desirable. Since these supports are generally located at intersecting roadways, there is a higher potential for a falling support to impact vehicles and/or pedestrians. In addition, signal supports that have overhead masts may be too heavy for a breakaway design to work properly. Other mitigation, such as installing a traffic barrier, is also very difficult. With vehicles approaching the support from many different angles, a barrier would have to surround the support and would be subject to impacts at high angles. Additionally, barrier can inhibit pedestrian movements. Therefore, barrier is generally not an option. However, since speeds near signals are generally lower, the potential for a severe impact is reduced. For these reasons, locate the support as far from the traveled way as possible.

In locations where signals are used for ramp meters, the supports can be made breakaway as shown in the *Standard Plans*.

(f) Fire Hydrants

Fire hydrants are allowed on WSDOT right of way by franchise or permit. Fire hydrants that are made of cast iron can be expected to fracture on impact and can therefore be considered a breakaway device. Any portion of the hydrant that will not be breakaway must not extend more than 4 inches above the ground. In addition, the hydrant must have a stem that will shut off water flow in the event of an impact. Mitigate other hydrant types.

(g) Utility Poles

Since utilities often share the right of way, utility objects such as poles are often located along the roadside. It is undesirable/infeasible to install barrier for all of these objects, so mitigation is usually in the form of relocation (underground or to the edge of the right of way) or delineation. In some instances where there is a history of impacts with poles and relocation is not possible, a breakaway design might be appropriate. Evaluate roadway geometry and crash history as an aid in determining locations that exhibit the greatest need.

Contact the Headquarters (HQ) Design Office for information on breakaway features. Coordinate with the HQ Utilities Unit when appropriate.

Document coordination with the region Utilities Office for evaluations and mitigative measures.

(h) Light Standards

Provide breakaway light standards unless fixed light standards can be justified. Fixed light standards may be appropriate in areas of extensive pedestrian concentrations, such as adjacent to bus shelters. Document the decision to use fixed bases in the Design Documentation Package.

(3) Water

Water with a depth of 2 feet or more and located with a likelihood of encroachment by an errant vehicle is to be considered for mitigation on a project-by-project basis. Consider the length of time traffic is exposed to this feature and its location in relationship to other highway features such as curves.

Analyze the potential risk to motorists and the benefits of treating bodies of water located within the Design Clear Zone. A cost-effectiveness analysis that considers the consequences of doing nothing versus installing a longitudinal barrier can be used to determine the appropriate treatment.

For fencing considerations along water features, see Chapter 560.

1600.06 Median Considerations

Medians are to be analyzed for the potential of an errant vehicle to cross the median and encounter oncoming traffic. Median barriers are normally used on limited access, multilane, high-speed, high-volume highways. These highways generally have posted speeds of 45 mph or higher. Median barrier is not normally placed on collectors or other state highways that do not have limited access control. Providing access through median barrier results in openings; therefore, end-treatments are needed.

Provide median barrier on full access control multilane highways with median widths of 50 feet or less and posted speeds of 45 mph or higher. Consider median barrier on highways with wider medians or lower posted speeds when there is a history of cross-median collisions.

When installing a median barrier, provide left-side shoulder widths as shown in Chapters 1130 and 1140 and shy distance as shown in Chapter 1610. Consider a wider shoulder area where the barrier might cast a shadow on the roadway and hinder the melting of ice. (See Chapter 1230 for additional criteria for placement of median barrier, Chapter 1610 for information on the types of barriers that can be used, and Chapter 1260 for lateral clearance on the inside of a curve to provide the needed stopping sight distance.)

Consideration of drainage is an important factor when designing median barrier treatments.

When median barrier is being placed in an existing median, identify the existing crossovers and enforcement observation points. Provide the needed median crossovers in accordance with Chapter 1370, considering enforcement needs. Chapter 1410 provides guidance on HOV enforcement.

1600.07 Other Roadside Safety Features

(1) Rumble Strips

Rumble strips are grooves or rows of raised pavement markers placed perpendicular to the direction of travel to alert inattentive drivers.

In Washington, most rumble strips consist of grooves milled into the pavement surface. Although most installations have not adversely affected the pavement, there have been a few instances where milled rumble strips have been associated with advanced levels of pavement deterioration, resulting in continuous ruts or large areas of pavement delamination. Poor pavement performance has most commonly been associated with rumble strip installations in bituminous surface treatment (BST) pavement and hot mix asphalt (HMA) pavement with low density, particularly along longitudinal joints. Rumble strip installation should be avoided in open-graded pavements. Consult with the Region Materials Engineer to ensure adequate pavement structure and thickness for all proposed rumble strip locations. Additionally, there are some specific surface preparation requirements for areas to be resurfaced where rumble strips currently exist. In many instances, it is necessary to remove and inlay the existing rumble strips prior to resurfacing. For additional guidance on surface preparation and pavement stability, refer to WSDOT's Pavement Policy: <http://wwwi.wsdot.wa.gov/maintops/mats/pavementguide.htm>

There are three kinds of rumble strips: roadway, shoulder, and centerline.

(a) Roadway Rumble Strips

Roadway rumble strips are placed transversely to the traveled way to alert drivers who are approaching a change of roadway condition or object that requires substantial speed reduction or other maneuvering. Some locations where roadway rumble strips may be used are in advance of:

- Stop-controlled intersections.
- Port of entry/customs stations.
- Lane reductions where collision history shows a pattern of driver inattention.
- Horizontal alignment changes where collision history shows a pattern of driver inattention.

They may also be placed at locations where the character of the roadway changes, such as at the end of a freeway.

Contact the HQ Design Office for additional guidance on the design and placement of roadway rumble strips.

Document decisions to use roadway rumble strips in the Design Documentation Package.

(b) Shoulder Rumble Strips

Shoulder rumble strips (SRS) are placed parallel to the traveled way just beyond the edge line to warn drivers they are entering a part of the roadway not intended for routine traffic use. Shoulder rumble strips are effective in reducing run-off-the-road collisions with the contributing circumstances of inattention, apparently fatigued, or apparently asleep.

When shoulder rumble strips are used, discontinue them where no edge stripe is present, such as at intersections and where curb and gutter are present. Discontinue shoulder rumble strips where shoulder driving is allowed. Where bicycle travel is allowed, discontinue shoulder rumble strips at locations where shoulder width reductions can cause bicyclists to move into or across the area where rumble strips would normally be placed, such as shoulders adjacent to bridges or longitudinal barrier with reduced shoulder widths.

Shoulder rumble strip patterns vary depending on the likelihood of bicyclists being present along the highway shoulder and whether they are placed on divided or undivided highways. Rumble strip patterns for undivided highways are shallower and may be narrower than patterns used on divided highways. They also provide gaps in the pattern, providing opportunities for bicycles to move across the pattern without having to ride across the grooves. There are four shoulder rumble strip patterns. Consult the *Standard Plans* for the patterns and construction details.

1. Divided Highways

Install shoulder rumble strips on both the right and left shoulders of rural Interstate highways. Consider them on both shoulders of rural divided highways. Use the Shoulder Rumble Strip Type 1 pattern on divided highways.

Omitting shoulder rumble strips on rural Interstate highways is a design exception (DE) under any of the following conditions:

- When another project scheduled within two years of the proposed project will overlay or reconstruct the shoulders or will use the shoulders for detours.
- When a pavement analysis determines that installing shoulder rumble strips will result in inadequate shoulder strength.
- When overall shoulder width will be less than 4 feet wide on the left and 6 feet wide on the right.

2. Undivided Highways

Shoulder rumble strip usage on the shoulders of undivided highways demands strategic application because bicycle usage is more prevalent along the shoulders of the undivided highway system. Rumble strips affect the comfort and control of bicycle riders; consequently, their use is to be limited to highway corridors that experience high levels of run-off-the-road collisions. Apply the following criteria in evaluating the appropriateness of rumble strips on the shoulders of undivided highways.

- Consult the region and Headquarters Bicycle and Pedestrian Coordinators to determine bicycle usage along a route, and involve them in the decision-making process when considering rumble strips along bike touring routes or other routes where bicycle events are regularly held.
- Use on rural roads only.
- Ensure shoulder pavement is structurally adequate to support milled rumble strips.
- Posted speed is 45 mph or higher.

- Provide for at least 4 feet of usable shoulder between the rumble strip and the outside edge of shoulder. If guardrail or barrier is present, increase the dimension to 5 feet of usable shoulder. Field verify these dimensions.
- Preliminary evaluation indicates a run-off-the-road collision experience of approximately 0.6 crashes per mile per year. (This value is intended to provide relative comparison of crash experience and is not to be used as absolute guidance on whether rumble strips are appropriate.)
- Do not place shoulder rumble strips on downhill grades exceeding 4% for more than 500 feet in length along routes where bicyclists are frequently present.
- An engineering analysis indicates a run-off-the-road collision experience considered correctable by shoulder rumble strips.

For projects that will remove and potentially replace existing shoulder rumble strips, evaluate the criteria for shoulder width and downhill grades for compliance with placement guidance. Discontinue rumble strips where the downhill grade exceeds 4% for more than 500 feet. If the usable shoulder width between the rumble strip and outer edge of shoulder is less than 4 feet (5 feet if guardrail or barrier is present) reevaluate the appropriateness of the rumble strips. Assess the existing shoulder rumble strip's impact on run-off-the-road crash experience and bicycling. Assess alternate rumble strip patterns and placement options. Consult the region and Headquarters Bicycle and Pedestrian Coordinators. Document decisions to continue or discontinue shoulder rumble strip usage where the existing usable shoulder width between the rumble strip and outer edge of shoulder is less than 4 feet (5 feet if guardrail or barrier is present).

The Shoulder Rumble Strip Type 2 or Type 3 pattern is used on highways with minimal bicycle traffic. When bicycle traffic on the shoulder is high, the Shoulder Rumble Strip Type 4 pattern is used.

Shoulder rumble strip installation considered at any other locations must involve the region and Headquarters Bicycle and Pedestrian Coordinators as a partner in the decision-making process.

Consult the following website for guidance on conducting an engineering analysis: www.wsdot.wa.gov/design/policy/roadsidesafety.htm

(c) Centerline Rumble Strips

Centerline rumble strips are placed on the centerline of undivided highways to alert drivers that they are entering the opposing lane. They are applied as a countermeasure for crossover collisions. Centerline rumble strips are installed with no differentiation between passing permitted and no passing areas. Refresh pavement markings when removed by centerline rumble strips.

A March 2011 WSDOT study found that centerline rumble strips were highly effective across the state highway network, and most effective on roadways where: the AADT is less than 8,000, the combined paved lane and shoulder width is 12 to 17 feet, and the posted speed is 45 to 55 mph.

Apply the following criteria when evaluating the appropriateness of centerline rumble strips:

- An engineering analysis indicates a crossover collision history with collisions considered correctable by centerline rumble strips. Review the collision history to determine the frequency of collisions with contributing circumstances such as inattention, apparently fatigued, apparently asleep, over the centerline, or on the wrong side of the road.
- Centerline rumble strips are most appropriate on rural roads, but with special consideration may also be appropriate for urban roads. Some concerns specific to urban areas are noise in densely populated areas, the frequent need to interrupt the rumble strip pattern to accommodate left-turning vehicles, and a reduced effectiveness at lower speeds (35 mph and below).
- Ensure the roadway pavement is structurally adequate to support milled rumble strips. Consult the Region Materials Engineer to verify pavement adequacies.
- Drivers tend to move to the right to avoid driving on centerline rumble strips. Centerline rumble strips are inappropriate when the combined lane and shoulder widths in either direction are less than 12 feet. (See Chapters 1130 and 1140 for guidance on lane and shoulder widths.) Narrow lane and shoulder widths may lead to dropping a tire off the pavement when drivers have shifted their travel path. Consider including centerline rumble strips on short sections of roadway that are below this width for route continuity.
- Centerline rumble strips are not appropriate where two-way left-turn lanes exist.

(2) **Headlight Glare Considerations**

Headlight glare from opposing traffic can cause potential safety problems. This can include glare from frontage roads. Glare can be reduced by the use of wide medians, separate alignments, earth mounds, plants, concrete barrier, and glare screens. Glare screen fencing may be effective for frontage roads. Consider long-term maintenance when selecting the treatment for glare. When considering earth mounds and plantings to reduce glare, see the *Roadside Manual* for additional guidance. When considering glare screens, see Chapter 1260 for lateral clearance on the inside of a curve to provide the necessary stopping sight distance. In addition to reducing glare, taller concrete barriers also provide improved crash performance for larger vehicles such as trucks.

Glare screen is relatively expensive, and its use is to be justified. It is difficult to justify the use of glare screen where the median width exceeds 20 feet, the ADT is less than 20,000 vehicles per day, or the roadway has continuous lighting. Consider the following factors when assessing the need for glare screen:

- Higher rate of night collision compared to similar locations or statewide experience.
- Higher than normal ratio of night-to-day collisions.
- Unusual distribution or concentration of nighttime collisions.
- Over-representation of older drivers in night collisions.
- Combination of horizontal and vertical alignment, particularly where the roadway on the inside of a curve is higher than the roadway on the outside of the curve.
- Direct observation of glare.
- Public complaints concerning glare.

The most common area with the potential for glare is between opposing main line traffic. Other conditions for which glare screen might be appropriate are:

- Between a highway and an adjacent frontage road or parallel highway, especially where opposing headlights might seem to be on the wrong side of the driver.
- At an interchange where an on-ramp merges with a collector-distributor and the ramp traffic might be unable to distinguish between collector and main line traffic. In this instance, consider other solutions such as illumination.
- Where headlight glare is a distraction to adjacent property owners. Playgrounds, ball fields, and parks with frequent nighttime activities might benefit from screening if headlight glare interferes with these activities.

There are currently three basic types of glare screen available: chain link (see the *Standard Plans*), vertical blades, and concrete barrier (see Exhibit 1600-7).

When the glare is temporary (due to construction activity), consider traffic volumes, alignment, duration, presence of illumination, and type of construction activity. Glare screen may be used to reduce rubbernecking associated with construction activity, but less expensive methods, such as plywood that seals off the view of the construction area, might be more appropriate.

1600.08 Documentation

For the list of documents required to be preserved in the Design Documentation Package and the Project File, see the Design Documentation Checklist:

🔗 www.wsdot.wa.gov/design/projectdev

Posted Speed (mph)	Average Daily Traffic	Cut Section (Backslope) (H:V)						Fill Section (H:V)					
		3:1	4:1	5:1	6:1	8:1	10:1	3:1	4:1	5:1	6:1	8:1	10:1
35 or Less		The Design Clear Zone Distance is 10 ft											
40	Under 250	10	10	10	10	10	10	*	13	12	11	11	10
	251 – 800	11	11	11	11	11	11	*	14	14	13	12	11
	801 – 2,000	12	12	12	12	12	12	*	16	15	14	13	12
	2,001 – 6,000	14	14	14	14	14	14	*	17	17	16	15	14
	Over 6,000	15	15	15	15	15	15	*	19	18	17	16	15
45	Under 250	11	11	11	11	11	11	*	16	14	13	12	11
	251 – 800	12	12	13	13	13	13	*	18	16	14	14	13
	801 – 2,000	13	13	14	14	14	14	*	20	17	16	15	14
	2,001 – 6,000	15	15	16	16	16	16	*	22	19	17	17	16
	Over 6,000	16	16	17	17	17	17	*	24	21	19	18	17
50	Under 250	11	12	13	13	13	13	*	19	16	15	13	13
	251 – 800	13	14	14	15	15	15	*	22	18	17	15	15
	801 – 2,000	14	15	16	17	17	17	*	24	20	18	17	17
	2,001 – 6,000	16	17	17	18	18	18	*	27	22	20	18	18
	Over 6,000	17	18	19	20	20	20	*	29	24	22	20	20
55	Under 250	12	14	15	16	16	17	*	25	21	19	17	17
	251 – 800	14	16	17	18	18	19	*	28	23	21	20	19
	801 – 2,000	15	17	19	20	20	21	*	31	26	23	22	21
	2,001 – 6,000	17	19	21	22	22	23	*	34	29	26	24	23
	Over 6,000	18	21	23	24	24	25	*	37	31	28	26	25
60	Under 250	13	16	17	18	19	19	*	30	25	23	21	20
	251 – 800	15	18	20	20	21	22	*	34	28	26	23	23
	801 – 2,000	17	20	22	22	23	24	*	37	31	28	26	25
	2,001 – 6,000	18	22	24	25	26	27	*	41	34	31	29	28
	Over 6,000	20	24	26	27	28	29	*	45	37	34	31	30
65	Under 250	15	18	19	20	21	21	*	33	27	25	23	22
	251 – 800	17	20	22	22	24	24	*	38	31	29	26	25
	801 – 2,000	19	22	24	25	26	27	*	41	34	31	29	28
	2,001 – 6,000	20	25	27	27	29	30	*	46	37	35	32	31
	Over 6,000	22	27	29	30	31	32	*	50	41	38	34	33
70	Under 250	16	19	21	21	23	23	*	36	29	27	25	24
	251 – 800	18	22	23	24	26	26	*	41	33	31	28	27
	801 – 2,000	20	24	26	27	28	29	*	45	37	34	31	30
	2,001 – 6,000	22	27	29	29	31	32	*	50	40	38	34	33
	Over 6,000	24	29	31	32	34	35	*	54	44	41	37	36

Notes:

This exhibit applies to:

- All state highways outside incorporated cities.
- Limited access state highways within cities.
- Median areas on managed access state highways within cities. (See 1600.04 for guidance on managed access state highways within incorporated cities.)

Curb is not considered adequate to redirect an errant vehicle.

Design Clear Zone distances are given in feet, measured from the edge of traveled way (see 1600.03.)

*When the fill section slope is steeper than 4H:1V, but not steeper than 3H:1V, the Design Clear Zone distance is modified by the recovery area formula (see Exhibit 1600-3) and is referred to as the recovery area. The basic philosophy behind the recovery area formula is that the vehicle can traverse these slopes but cannot recover (control steering); therefore, the horizontal distance of these slopes is added to the Design Clear Zone distance to form the recovery area.

Design Clear Zone Distance Table

Exhibit 1600-1

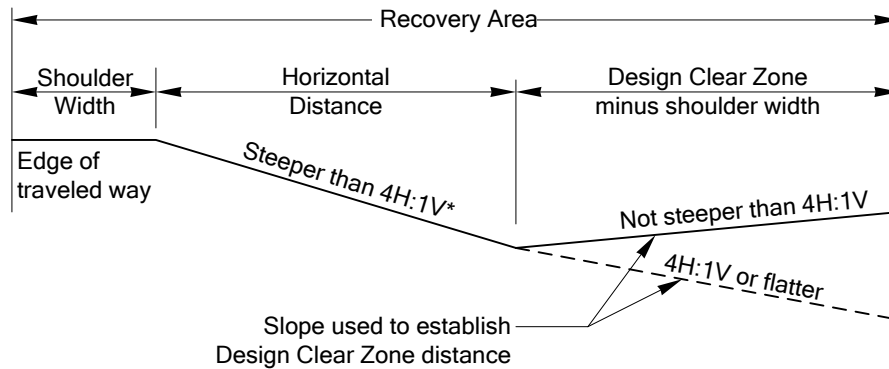

*Recovery area normally applies to slopes steeper than 4H:1V, but not steeper than 3H:1V. For steeper slopes, the recovery area formula may be used as a guide if the embankment height is 10 ft or less.

Formula:

$$\text{Recovery area} = (\text{shoulder width}) + (\text{horizontal distance}) \\ + (\text{Design Clear Zone distance} - \text{shoulder width})$$

Example:

Fill section (slope 3H:1V or steeper)

Conditions: Speed – 45 mph
Traffic – 3,000 ADT
Slope – 3H:1V

Criteria: Slope 3H:1V – Use recovery area formula

$$\text{Recovery area} = (\text{shoulder width}) + (\text{horizontal distance}) \\ + (\text{Design Clear Zone distance} - \text{shoulder width}) \\ = 8 + 12 + (17-8) \\ = 29 \text{ feet}$$

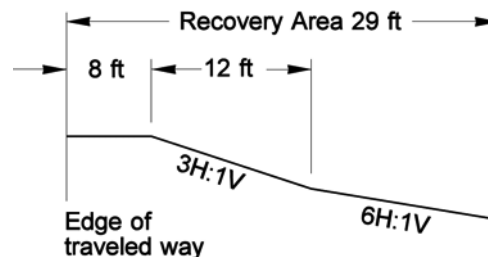

Recovery Area Exhibit 1600-3

Cut section with ditch (foreslope 4H:1V or flatter)

Conditions: Speed – 55 mph
 Traffic – 4,200 ADT
 Slope – 4H:1V

Criteria: Greater of:

- (1) Design Clear Zone for 10H:1V cut section, 23 feet
- (2) 5 feet horizontal beyond beginning of backslope, 22 feet

Design Clear Zone = 23 feet

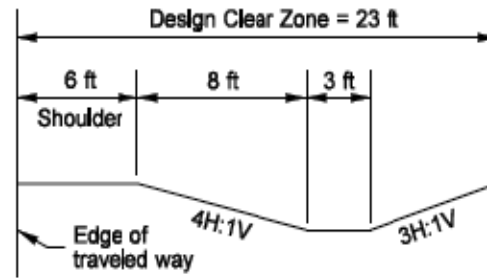

Case 1

Cut section with ditch (foreslope steeper than 4H:1V and backslope steeper than 3H:1V)

Conditions: NA

Criteria: 10 feet horizontal beyond beginning of backslope

Design Clear Zone = 19 feet

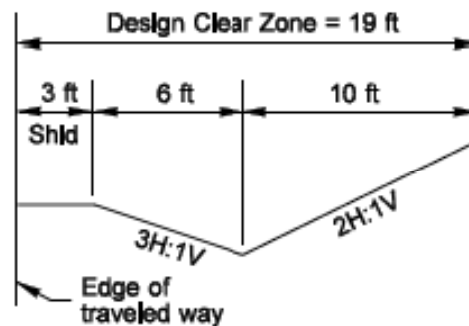

Case 2

Cut section with ditch (foreslope 3H:1V or steeper and backslope not steeper than 3H:1V)

Conditions: Speed – 45 mph
 Traffic – 3,000 ADT
 Foreslope – 2H:1V
 Backslope – 4H:1V

Criteria: Use recovery area formula

$$\begin{aligned}
 \text{Recovery Area} &= (\text{shoulder width}) + (\text{horizontal distance}) \\
 &\quad + (\text{Design Clear Zone distance} \\
 &\quad - \text{shoulder width}) \\
 &= 6 + 6 + (15 - 6) \\
 &= 21 \text{ feet}
 \end{aligned}$$

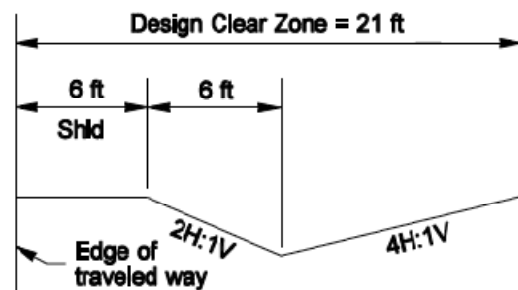

Case 3

Design Clear Zone for Ditch Sections

Exhibit 1600-4

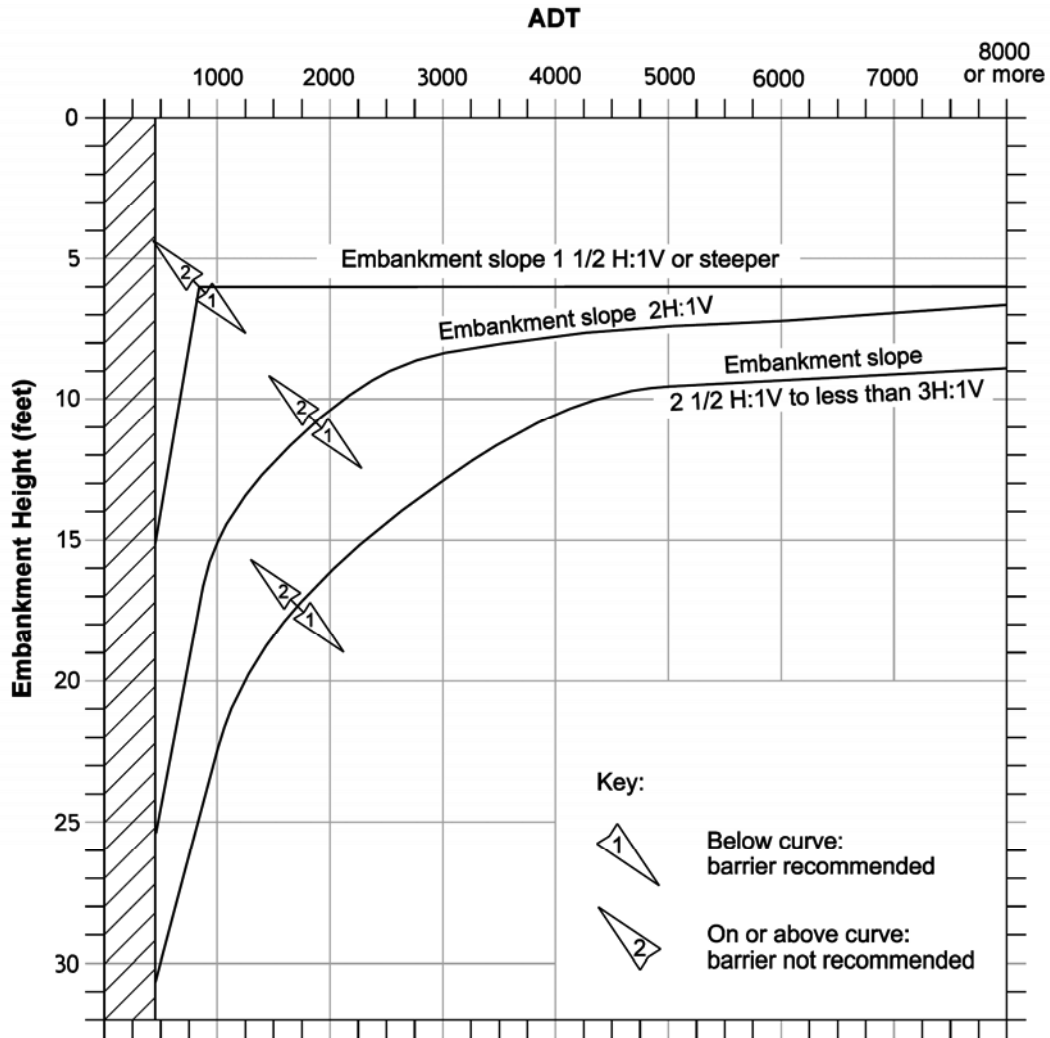

Note:

Routes with ADTs under 400 may be evaluated on a case-by-case basis.

Guidelines for Embankment Barrier

Exhibit 1600-5

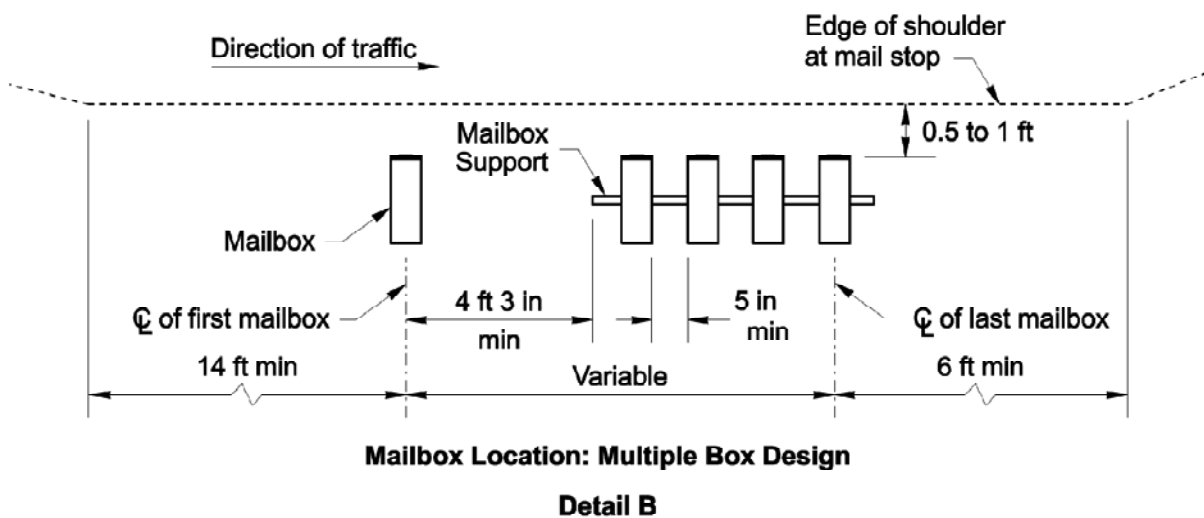
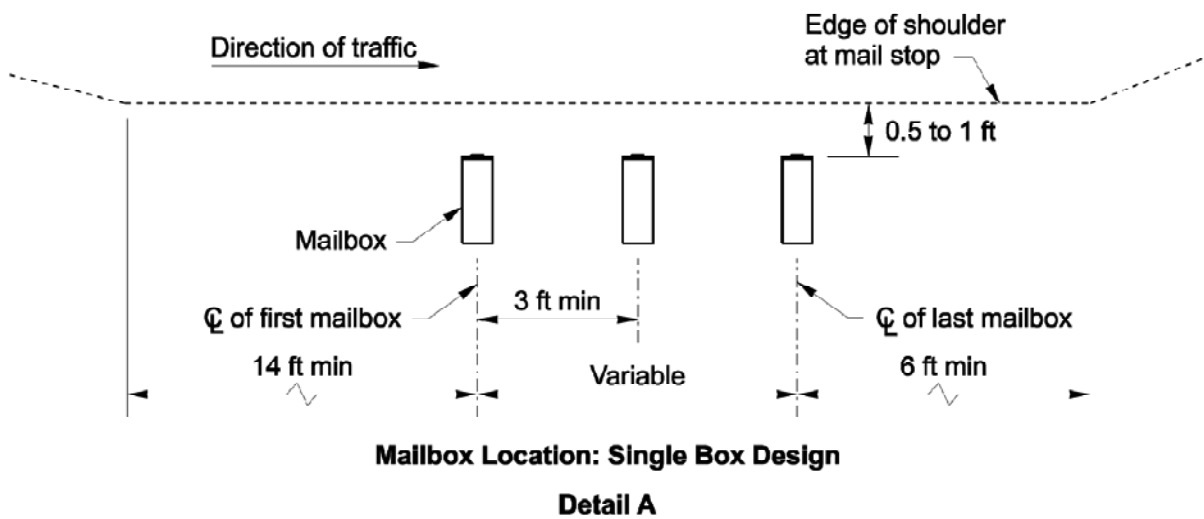
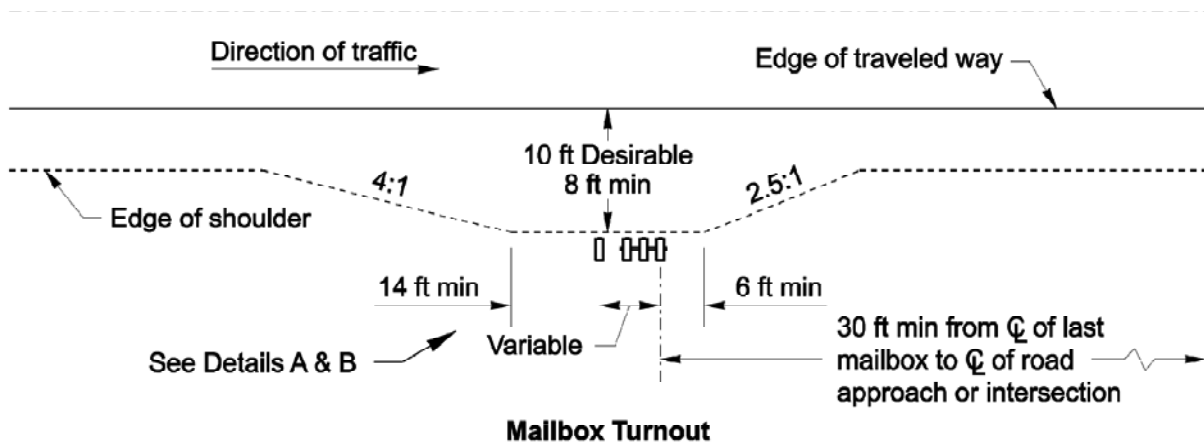

Mailbox Location and Turnout Design
Exhibit 1600-6

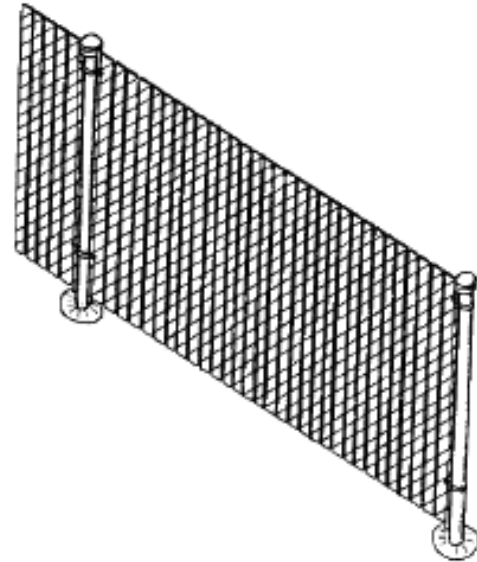
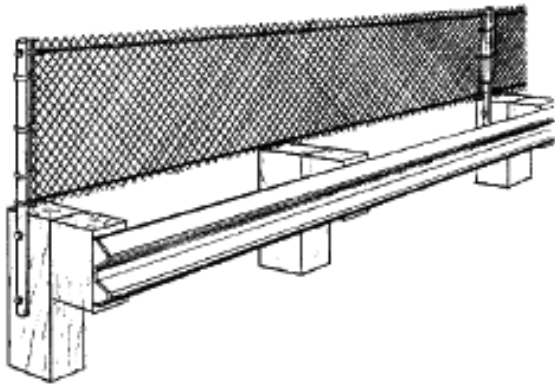

Chain Link

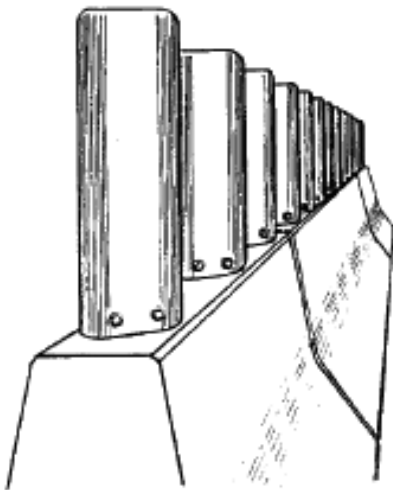

Vertical Blades

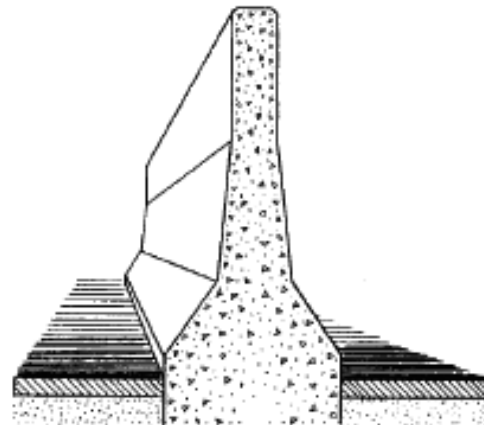

Concrete Barrier

Glare Screens
Exhibit 1600-7

1610.01	General	1610.07	Cable Barrier
1610.02	References	1610.08	Concrete Barrier
1610.03	Definitions	1610.09	Special-Use Barriers
1610.04	Project Criteria	1610.10	Bridge Traffic Barriers
1610.05	Barrier Design	1610.11	Other Barriers
1610.06	Beam Guardrail	1610.12	Documentation

1610.01 General

The Washington State Department of Transportation (WSDOT) uses traffic barriers to reduce the overall severity of collisions that occur when a vehicle leaves the traveled way. Consider whether a barrier is preferable to the recovery area it replaces. In some cases, installation of a traffic barrier may result in more collisions, as it presents an object that can be struck. Barriers are designed so that such encounters might be less severe and not lead to secondary or tertiary collisions. However, when impacts occur, traffic barriers are not guaranteed to redirect vehicles without injury to the occupants or additional collisions.

Barrier performance is affected by the characteristics of the types of vehicles that collide with them. For example, motor vehicles with large tires and high centers of gravity are commonplace on our highways and they are designed to mount obstacles. Therefore, they are at greater risk of mounting barriers or of not being decelerated and redirected as conventional vehicles would be.

When barriers are crash-tested, it is impossible to replicate the innumerable variations in highway conditions. Therefore, barriers are crash-tested under standardized conditions. These standard conditions were previously documented in National Cooperative Highway Research Program (NCHRP) Report 350. These guidelines have been updated and are now presented in the *Manual for Assessing Safety Hardware (MASH)*.

Barriers are not placed with the assumption that the system will restrain or redirect all vehicles in all conditions. They are placed with the assumption that under normal conditions, they might provide an improved safety condition for most collisions. Consequently, barriers should not be used unless an improved safety situation is likely. No matter how well a barrier system is designed, optimal performance is dependent on drivers' proper use, maintenance, and operation of their vehicles and the proper use of vehicle restraint systems.

At the time of installation, the ultimate choice of barrier type and placement is made by gaining an understanding of site and traffic conditions, having a thorough understanding of and using the criteria presented in Chapters 1600 and 1610, and using engineering judgment.

1610.02 References

(1) Design Guidance

Bridge Design Manual, M 23-50, WSDOT

Roadside Design Guide, AASHTO, 2006

Standard Plans for Road, Bridge, and Municipal Construction (Standard Plans), M 21-01, WSDOT

Traffic Manual, M 51-02, WSDOT

(2) Supporting Information

NCHRP 350, TRB, 1993

Manual for Assessing Safety Hardware (MASH), AASHTO, 2009

1610.03 Definitions

barrier terminal A crash-tested end treatment for longitudinal barriers that is designed to reduce the potential for spearing, vaulting, rolling, or excessive deceleration of impacting vehicles from either direction of travel. Barrier terminals include applicable anchorage.

controlled releasing terminal (CRT) post A standard-length guardrail post that has two holes drilled through it so it might break away when struck.

crash-accepted device A feature that has been proven acceptable for use under specified conditions, either through crash testing or in-service performance.

fixed feature (object to be mitigated) A fixed object, a sideslope, or water that, when struck, can result in impact forces on a vehicle's occupants that may result in injury or place the occupants in a situation that has a high likelihood of injury. A fixed feature can be either constructed or natural.

impact attenuator system A device that acts primarily to bring an errant vehicle to a stop at a deceleration rate tolerable to the vehicle's occupants or to redirect the vehicle away from a fixed feature.

length of need The length of a traffic barrier used to shield a fixed feature.

shy distance The distance from the edge of the traveled way beyond which a roadside object might not be perceived by a typical driver as an immediate feature to be avoided to the extent that the driver will change the vehicle's placement or speed.

traffic barrier/longitudinal barrier A device oriented parallel or nearly parallel to the roadway whose primary function is to contain or safely redirect errant vehicles away from fixed features or to (occasionally) protect workers, pedestrians, or bicyclists from vehicular traffic. Beam guardrail, cable barrier, bridge rail, concrete barrier, and impact attenuators are barriers, and they are categorized as rigid, rigid anchored, unrestrained rigid, semirigid, and flexible. They can be installed as roadside or median barriers.

transition A section of barrier used to produce the gradual stiffening of a flexible or semirigid barrier as it connects to a more rigid barrier or fixed object.

1610.04 Project Criteria

This section identifies the barrier elements that are addressed according to the Design Matrices in Chapter 1100. Remove barrier that is not needed. Use the criteria in Chapter 1600 as the basis for removal.

(1) **Barrier Terminals and Transitions**

Install, replace, or upgrade transitions as discussed in 1610.06(6), Transitions and Connections.

Impact attenuator criteria can be found in Chapter 1620, Impact Attenuator Systems. Concrete barrier terminal criteria can be found in 1610.08(3).

When installing new terminals, consider extending the guardrail to meet the length-of-need criteria found in 1610.05(5) as a spot safety enhancement, which is a modification to isolated roadway or roadside features that, in the engineer's judgment, reduce potential for collision frequency or severity.

When the end of a barrier has been terminated with a small mound of earth, remove and replace with a crash-tested terminal, except as noted in 1610.09.

Redirectional landforms, also referred to as earth berms, were formerly installed to help mitigate collisions with fixed objects located in depressed medians and at roadsides. They were constructed of materials that provided support for a traversing vehicle. With slopes in the range of 2H:1V to 3H:1V, they were intended to redirect errant vehicles. The use of redirection landforms has been discontinued. Where redirection landforms currently exist as mitigation for a fixed object, provide alternative means of mitigation of the fixed object, such as remove, relocate, upgrade with crash-tested systems, or shield with barrier. Landforms may be used to provide a smooth surface at the base of a rock cut slope.

Replace guardrail terminals that do not have a crash-tested design with crash-tested guardrail terminals (see 1610.06(5), Terminals and Anchors). Common features of systems that do not meet current crash-tested designs include:

- No cable anchor.
- A cable anchored into concrete in front of the first post.
- Second post not breakaway (CRT).
- Design A end section (Design C end sections may be left in place—see the *Standard Plans* for end section details).
- Terminals with beam guardrail on both sides of the posts (two-sided).
- Buried guardrail terminals that slope down such that the guardrail height is reduced to less than 26 inches.

When the height of an existing terminal will be reduced to less than 26 inches from the ground to the top of the rail element, adjust the height to a minimum of 26 inches and a maximum of 28 inches. A rail height of 28 inches is desirable to accommodate future overlays. When adjusting terminals that are equipped with CRT posts, the top-drilled holes in the posts need to remain at the surface of the ground.

One terminal that was used extensively on Washington's highways was the Breakaway Cable Terminal (BCT). This system used a parabolic flare similar to the Slotted Rail Terminal (SRT) and a Type 1 anchor. (Type 1 anchor posts are wood set in a steel tube or a concrete foundation.)

Replace BCTs on Interstate routes. On non-Interstate routes and Interstate ramps, BCTs that have at least a 3-foot offset may remain in place unless the guardrail run or anchor is being reconstructed or reset. (Raising the rail element is not considered reconstruction or resetting.)

Existing transitions that do not have a curb but are otherwise consistent with the designs shown in the *Standard Plans* may remain in place.

For Preservation projects, terminal and transition work may be programmed under a separate project, as described in Chapter 1120.

(2) Standard Run of Barrier

In Chapter 1100, the Design Matrices offer guidance on how to address standard barrier runs for different project types. A "Standard Run" of barrier consists of longitudinal barrier as detailed in the *Standard Plans*.

(a) Basic Design Level (B)

When the basic design level (B) is indicated in the Standard Run column of a Design Matrix, and the height of W-beam guardrail is or would be reduced to less than 26 inches from the ground to the top of the rail element, adjust the height to a minimum of 26 inches and a maximum of 28 inches. A rail height of 28 inches is desirable to accommodate future overlays.

If Type 1 Alternate W-beam guardrail is present, raise the rail element after each overlay. If Type 1 Alternate is not present, raise the existing blockout up to 4 inches higher than the top of the existing post by boring a new hole in the post.

Overlays in front of safety shape concrete barriers can extend to the top of the lower, near-vertical face of the barrier before adjustment is necessary.

- Allow no more than 1 foot 1 inch from the pavement to the beginning of the top near-vertical face of the safety shape barriers.
- Allow no less than 2 feet 8 inches from the pavement to the top of the single-slope barrier.
- Allow no less than 35 inches to the center of the top cable for four-cable high-tension cable barriers.

Note: There are new high-tension cable barrier systems under development, which may change the selection and placement criteria. The Headquarters (HQ) Design Office will circulate guidance on these new developments as they are adopted as WSDOT policy.

(b) Full Design Level (F)

When the full design level (F) is indicated, in addition to the criteria for the basic design level, the barrier is to meet the criteria in the following:

Chapter	Subject
1600.06	Median considerations
1610.05(2)	Shy distance
1610.05(3)	Barrier deflections
1610.05(4)	Flare rate
1610.05(5)	Length of need
1610.05(6)	Median barrier selection and placement considerations
1610.06	Beam guardrail
1610.07	Cable barrier
1610.08	Concrete barrier

Examples of barriers that *are not* acceptable as a “Standard Run” are:

- W-beam guardrail with 12-foot-6-inch post spacing or no blockouts, or both.
- W-beam guardrail on concrete posts.
- Cable barrier on wood or concrete posts.
- Half-moon or C-shaped rail elements.

(3) Bridge Rail

When the Bridge Rail column of a Design Matrix applies to the project, the bridge rails, including crossroad bridge rail, are to meet the following criteria:

- Use an approved, crash-tested concrete bridge rail on new bridges or bridges to be widened. The *Bridge Design Manual* provides examples of typical bridge rails. Consult the HQ Bridge and Structures Office regarding bridge rail selection and design and for design of the connection to an existing bridge.
- An existing bridge rail on a highway with a posted speed of 30 mph or below may remain in place if it is not located on a bridge over a National Highway System (NHS) highway. When Type 7 bridge rail is present on a bridge over an NHS highway with a posted speed of 30 mph or below, it may remain in place regardless of the type of metal rail installed. Other bridge rails are to be evaluated for strength and geometrics. (See 1610.10 for guidance on retrofit techniques.)
- The Type 7 bridge rail is common. Type 7 bridge rails have a curb, a vertical-face parapet, and an aluminum top rail. The curb width and the type of aluminum top rail are factors in determining the adequacy of the Type 7 bridge rail, as shown in Exhibit 1610-1. Consult the HQ Bridge and Structures Office for assistance in evaluating other bridge rails.

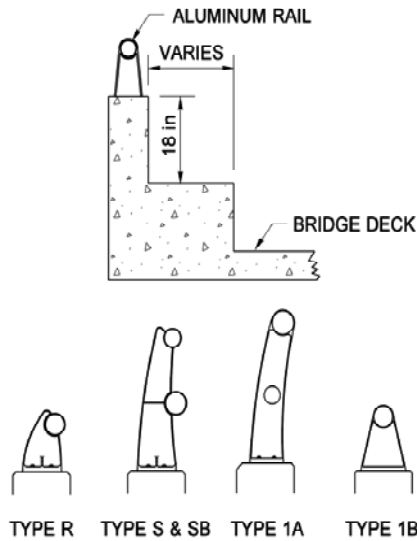

Aluminum Rail Type	Curb Width	
	9 Inches or Less	Greater Than 9 Inches*
Type R, S, or SB	Bridge rail adequate	Bridge rail adequate
Type 1B or 1A	Bridge rail adequate	Upgrade bridge rail
Other	Consult the HQ Bridge and Structures Office	

*When the curb width is greater than 9 inches, the aluminum rail must be able to withstand a 5 kip load.

Type 7 Bridge Rail Upgrade Criteria
Exhibit 1610-1

1610.05 Barrier Design

When selecting a barrier, consider the flexibility, cost, and maintainability of the system. It is generally desirable to use the most flexible system possible to minimize damage to the impacting vehicle and injury to the vehicle’s occupant(s). However, since nonrigid systems sustain more damage during an impact, the exposure of maintenance crews to traffic might be increased with the more frequent need for repairs.

Maintenance costs for concrete barrier are lower than for other barrier types. In addition, deterioration due to weather and vehicle impacts is less than most other barrier systems. Unanchored precast concrete barrier can usually be realigned or repaired when moved from its alignment. However, heavy equipment may be necessary to reposition or replace barrier segments. Therefore, in medians, consider the shoulder width and the traffic volume when determining the acceptability of unanchored precast concrete barrier versus rigid concrete barrier.

Drainage, alignment, and drifting snow or sand are considerations that can influence the selection of barrier type. Beam guardrail and concrete barrier can contribute to snow drifts. Consider long-term maintenance costs associated with snow removal at locations prone to snow drifting. Slope flattening is recommended when the safety benefit justifies the additional cost to eliminate the need for the barrier. Cable barrier is not an obstruction to drifting snow and can be used if slope flattening is not feasible.

With some systems, such as concrete and beam guardrail, additional shoulder widening or slope flattening is common. However, selection of these types of barriers is sometimes limited due to the substantial environmental permitting and highway reconstruction needs. Permits issued under the SEPA and NEPA processes may lead to the use of a barrier design such as cable barrier, which has fewer potential environmental impacts and costs.

When designing a barrier for use on a Scenic Byway, consider barriers that are consistent with the recommendations in the associated corridor management plan (if one is available). Contact the region Landscape Architect or the Scenic Byways Coordinator in the HQ Highways and Local Programs Office to determine whether the project is on such a designated route. Low-cost options, such as using weathering steel beam guardrail (see 1610.06) or cable barrier (see 1610.07), might be feasible on many projects. Higher-cost options, such as steel-backed timber rail and stone guardwalls (see 1610.09), might necessitate a partnering effort to fund the additional costs. Grants might be available for this purpose if the need is identified early in the project definition phase (see Chapter 120).

(1) Sight Distance

When selecting and placing a barrier system, consider the possible impact the barrier type and height may have on sight distance. In some cases, barriers may restrict the sight distances of road users entering the roadway, such as from road approaches, intersections, and other locations. In these cases, the barrier may need to be adjusted to meet the required sight distance requirements at these locations.

(2) Shy Distance

Provide 2 feet of additional widening for shy distance when a barrier is to be installed in areas where the roadway is to be widened and the shoulder width will be less than 8 feet. This shy distance is not needed when the section of roadway is not being widened or the shoulders are at least 8 feet wide. (See criteria in Chapter 1140 for exceptions.)

(3) Barrier Deflections

Expect all barriers except rigid barriers (such as concrete bridge rails) to deflect when hit by an errant vehicle. The amount of deflection is primarily dependent on the stiffness of the system. However, vehicle speed, angle of impact, and weight also affect the amount of barrier deflection. For flexible and semirigid roadside barriers, the deflection distance is designed to help prevent the impacting vehicle from striking the object being shielded. For unrestrained rigid systems (unanchored precast concrete barrier), the deflection distance is designed to help prevent the barrier from being knocked over the side of a drop-off or steep fill slope (2H:1V or steeper).

In median installations, design systems such that the anticipated deflection will not enter the lane of opposing traffic using deflection values that were determined from crash tests. When evaluating new barrier installations, consider the impacts where significant traffic closures are necessary to accomplish maintenance. Use a rigid system where deflection cannot be tolerated, such as in narrow medians or at the edge of bridge decks or other vertical drop-off areas. Runs of rigid concrete barrier can be cast in place or extruded with appropriate footings.

In some locations where deflection distance is limited, anchor precast concrete barrier. Unless the anchoring system has been designed to function as a rigid barrier, some movement can be expected and repairs may be more expensive. Use of an anchored or other deflecting barrier on top of a retaining wall without deflection distance provided requires approval from the HQ Design Office.

Refer to Exhibit 1610-2 for barrier deflection design values when selecting a longitudinal barrier. The deflection distances for cable and beam guardrail are the minimum measurements from the face of the barrier to the fixed feature. The deflection distance for unanchored concrete barrier is the minimum measurement from the back edge of the barrier to the drop-off or slope break.

Barrier Type	System Type	Deflection
Cable barrier or beam guardrail, Types 20 and 21, on G-2 posts	Flexible	Up to 12 ft (face of barrier to object)
Beam guardrail, Types 1, 1a, 2, 10, and 31	Semirigid	3 ft (face of barrier to object)
Two-sided W-beam guardrail, Types 3 and 4	Semirigid	2 ft (face of barrier to object)
Permanent concrete barrier, unanchored	Rigid <u>Unrestrained</u>	3 ft ^[1] (back of barrier to object)
Temporary concrete barrier, unanchored	Rigid <u>Unrestrained</u>	2 ft ^[2] (back of barrier to object)
Precast concrete barrier, anchored	Rigid <u>Anchored</u>	6 inches (back of barrier to object)
Rigid concrete barrier	Rigid	No deflection
Notes:		
[1] When placed in front of a 2H:1V or flatter fill slope, the deflection distance can be reduced to 2 feet.		
[2] When used as temporary bridge rail, anchor all barrier within 3 feet of a drop-off.		

Longitudinal Barrier Deflection

Exhibit 1610-2

(4) Flare Rate

Flare the ends of longitudinal barriers where practicable. The four functions of a flare are to:

- Locate the barrier and its terminal as far from the traveled way as feasible.
- Reduce the length of need.
- Redirect an errant vehicle.
- Minimize a driver's reaction to the introduction of an object near the traveled way.

Keeping flare rates as flat as practicable preserves the barrier's redirection performance and minimizes the angle of impact. However, it has been shown that an object (or barrier) close to the traveled way might cause a driver to shift laterally, slow down, or both. The flare reduces this reaction by gradually introducing the barrier so the driver does not perceive the barrier as an object to be avoided. The flare rates in Exhibit 1610-3 are intended to satisfy the four functions listed above. More gradual flares may be used. Flare rates are offset parallel to the edge of the traveled way. Transition sections are not normally flared.

Posted Speed (mph)	Rigid & Rigid Anchored System	Unrestrained Rigid System	Semirigid System
65–70	20:1	18:1	15:1
60	18:1	16:1	14:1
55	16:1	14:1	12:1
50	14:1	12:1	11:1
45	12:1	11:1	10:1
40 or below	11:1	10:1	9:1

Longitudinal Barrier Flare Rates

Exhibit 1610-3

(5) Length of Need

The length of traffic barrier needed to shield a fixed feature (length of need) is dependent on the location and geometrics of the object, direction(s) of traffic, posted speed, traffic volume, and type and location of traffic barrier. When designing a barrier for a fill slope (see Chapter 1600), the length of need begins at the point where the need for barrier is recommended. For fixed objects and water, Exhibits 1610-10a and 10b show design parameters for determining the needed length of a barrier for both adjacent and opposing traffic on relatively straight sections of highway.

When barrier is to be installed on the outside of a horizontal curve, the length of need can be determined graphically, as shown in Exhibit 1610-10c. For installations on the inside of a curve, determine the length of need as though it were straight. Also, consider the flare rate, barrier deflection, and barrier end treatment to be used.

When beam guardrail is placed in a median, consider the potential for impact from opposing traffic when conducting a length of need analysis. When guardrail is placed on either side of objects in the median, consider whether the trailing end of each run of guardrail will shield the leading end of the opposing guardrail. Shield the leading end when it is within the Design Clear Zone of opposing traffic (see Exhibit 1610-10d).

Before the actual length of need is determined, establish the lateral distance between the proposed barrier installation and the object shielded. Provide a distance that is greater than or equal to the anticipated deflection of the longitudinal barrier. (See Exhibit 1610-2 for barrier deflections.) Place the barrier as far from the edge of the traveled way as possible while maintaining the deflection distance.

If the end of the length of need is near an adequate cut slope, extend the barrier and embed it in the slope (see 1610.06(5)). Avoid gaps of 300 feet or less. Short gaps are acceptable when the barrier is terminated in a cut slope. If the end of the length of need is near the end of an existing barrier, it is recommended that the barriers be connected to form a continuous barrier. Consider maintenance access issues when determining whether or not to connect barriers.

(6) Median Barrier Selection and Placement Considerations

The most desirable barrier installation uses the most flexible system appropriate for the location and one that is placed as far from the traveled way as practicable. Engineers are faced with the fact that barrier systems and vehicle fleets continue to evolve. What may be an optimal choice of barrier based on the majority of vehicles on the road today may not be the best selection for vehicles on the road in the foreseeable future. This continuum of change does not allow engineers to predict the future with any degree of certainty. Consequently, engineering decisions need to be made based on the most reliable and current information.

Engineers are constantly striving to develop more effective design features to improve highway safety. However, economics and feasibility do not permit new designs to be employed as soon as they are invented. The fact that a new design has been developed does not mean that the old design is unsafe. Although new designs may have been tested under controlled conditions, their performance under relevant applications may demonstrate unexpected performance aspects. Therefore there may be a need to modify application methods based on that practical experience.

Good engineering judgment is called for in determining the appropriate placement of barrier systems. Solutions may need to be arrived at while considering competing factors such as collision frequency and severity. As discussed previously, performance of the system relies on the interaction of the vehicle, driver, and system design at any given location.

With median barriers, the deflection characteristics and placement of the barrier for a traveled way in one direction can have an impact on the traveled way in the opposing direction. In addition, the median slopes and environmental issues often influence the type of barrier that is appropriate.

In narrow medians, avoid placement of barrier where the design deflection extends into oncoming traffic. Narrow medians provide little space for maintenance crews to repair or reposition the barrier. Therefore, avoid installing deflecting barriers in medians that provide less than 8 feet from the edge of the traveled way to the face of the barrier.

In wider medians, the selection of barrier might depend on the slopes in the median. At locations where the median slopes are relatively flat (10H:1V or flatter), unrestrained precast concrete barrier, beam guardrail, and cable barrier can be used depending on the available deflection distance. At these locations, position the barrier as close to the center as possible so that the recovery distance can be maximized for both directions. There may be a need to offset the barrier from the flow line to avoid impacts to the drainage flow.

In general, cable barrier is recommended with medians that are 30 feet or wider. However, cable barrier may be appropriate for narrower medians if adequate deflection distance exists. In wide medians where the slopes are steeper than 10H:1V but not steeper than 6H:1V, cable barrier placed near the center of the median is preferable. For additional cable barrier placement guidance, see Exhibits 1610-13a through 13c. Place beam guardrail at least 12 feet from the slope breakpoint, as shown in Exhibit 1610-4. Do not use concrete barrier at locations where the foreslope into the face of the barrier is steeper than 10H:1V.

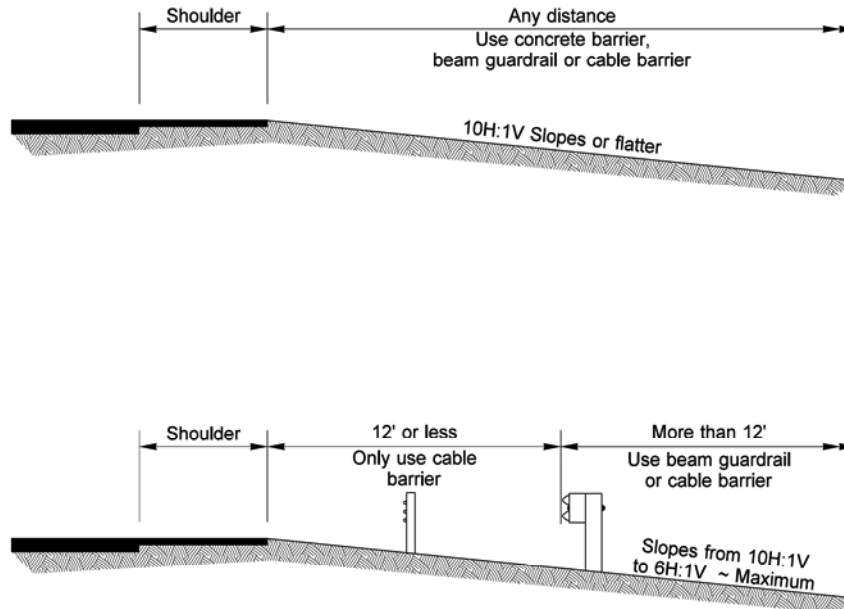

Traffic Barrier Locations on Slopes

Exhibit 1610-4

At locations where the roadways are on independent alignments and there is a difference in elevation between the roadways, the slope from the upper roadway might be steeper than 6H:1V. In these locations, position the median barrier along the upper roadway and provide deflection and offset distance as discussed previously. Barrier is generally not needed along the lower roadway except where there are fixed features in the median.

When W-beam barrier is placed in a median as a countermeasure for cross-median collisions, design the barrier to be struck from either direction of travel. For example, the installation of beam guardrail might be double-sided (Type 31-DS).

1610.06 Beam Guardrail

(1) Beam Guardrail Systems

Beam guardrail systems are shown in the *Standard Plans*.

Strong post W-beam guardrail (Types 1 through 4, and 31) and thrie beam guardrail (Types 10 and 11) are semirigid barriers used predominantly on roadsides. They have limited application as median barrier. Installed incorrectly, strong post W-beam guardrail can cause vehicle snagging or spearing. This can be avoided by lapping the rail splices in the direction of traffic (as shown in the *Standard Plans*), by using crash-tested end treatments, and by blocking the rail away from the strong posts. However, avoid the use of blockouts that extend from the post to the rail element for a distance exceeding 16 inches. Placement of curb at guardrail installations also requires careful consideration.

Previously, WSDOT standard practice was to install W-beam guardrail at a rail height of 27 inches. However, there are newer designs that use a 31-inch rail height. One is the 31-inch-high WSDOT Type 31. The Type 31 system uses many of the same components as the WSDOT Type 1 system. However, the main differences are that the blockouts extend 12 inches from the posts, the rail height is 31 inches from the ground to the top of the rail, and the rail elements are spliced between posts.

The 31-inch-high system offers tolerance for future HMA overlays. The Type 31 system allows a 3-inch tolerance from 31 inches to 28 inches without adjustment of the rail element.

(2) W-Beam Barrier Selection and Placement

During the project development processes, consult with maintenance staff to help identify guardrail runs that may need to be upgraded.

- Use the 31-inch-high guardrail design for new runs. When guardrail is installed along existing shoulders with a width greater than 4 feet, the shoulder width may be reduced by 4 inches to accommodate the 12-inch blockout without processing deviation.
- Existing runs with rail height at 27 inches are acceptable to leave in place and can be extended if the design height of 27 inches is maintained in the extended section. Where future overlays are anticipated, extend with Type 1 alternate or the 31-inch design.
- For existing runs below 26 inches, adjust or replace the rail to a height of 26 inches minimum to 28 inches maximum, or replace the run with the 31-inch-high guardrail design.
- Some 31-inch-high proprietary guardrail designs that do not incorporate the use of blockouts have been successfully crash-tested. The use of this type of system may be appropriate for some applications. Contact the HQ Design Office for further details.

Some designs for Type 31 applications are under development and will be added to the HQ Design Standards (Plan Sheet Library) as soon as they are completed (www.wsdot.wa.gov/design/standards/plansheet). Plans will be housed at this location until they are transitioned into the *Standard Plans*. Note: If a design is not available for the Type 31 guardrail system, a Type 1 guardrail design may be used without processing a deviation.

(3) Beam Guardrail Post Selection Criteria

- WSDOT has experienced inconsistencies in the service life of wood guardrail posts. As a result, WSDOT conducted a life cycle analysis and has elected to discontinue the use of wood guardrail posts for new guardrail runs. Use steel posts for new beam guardrail runs. (Note: For projects with Design Approval prior to December 2009, wood posts may remain as an option for new installations.)
- Existing runs of guardrail with wooden posts are acceptable to leave in place if in good condition and minimum height criteria can be maintained. (See 1610.06(2) for additional guidance.)
- Posts in an existing wooden guardrail run may be replaced in kind.
- It is acceptable to extend existing wood post guardrail runs with either steel or wood posts and also with the associated approved wood or steel post terminals, anchors, and so on.

- When removing and resetting guardrail runs, consider using steel posts and reusing or replacing other components and hardware depending on condition.

(4) **Additional Guidance**

- Weak post W-beam guardrail (Type 20) and three beam guardrail (Type 21) are flexible barrier systems that can be used where there is adequate deflection distance. These systems use weak steel posts. The primary purpose of these posts is to position the guardrail vertically, and they are designed to bend over when struck. These more flexible systems will likely result in less damage to the impacting vehicle. Since the weak posts will not result in snagging, blockouts are not necessary.
- Keep the slope of the area between the edge of the shoulder and the face of the guardrail 10H:1V or flatter. On fill slopes between 6H:1V and 10H:1V, avoid placing within 12 feet of the break point. Do not place beam guardrail on a fill slope steeper than 6H:1V. (See Exhibit 1610-4 for additional guidance on beam guardrail slope placement.)
- On the high side of superelevated sections, place beam guardrail at the edge of shoulder prior to the slope break.
- For W-beam guardrail installed at or near the shoulder, 2 feet of shoulder widening behind the barrier is generally provided from the back of the post to the beginning of a fill slope (see Exhibit 1610-11, Case 2). If the slope is 2H:1V or flatter, this distance can be measured from the face of the guardrail rather than the back of the post (see Exhibit 1610-11, Case 1).
- On projects where no roadway widening is proposed and the minimum 2-foot shoulder widening behind the barrier is not practicable, long post installations are available as shown in Exhibit 1610-11, Cases 3, 4, 5, and 6. When guardrail is to be installed in areas where the roadway is to be widened or along new alignments, the use of Cases 4, 5, and 6 requires a design deviation.
- Rail washers on beam guardrail are not normally used. If rail washers are present, removal is not necessary except for posts 2 through 8 of an existing BCT installation. However, if the rail element is removed for any reason, do not reinstall rail washers. In areas where heavy snow accumulations are expected to cause the bolts to pull out, specify snowload post washers and rail washers in the contract documents. (Snowload post washers are used to help prevent the bolts from pulling through the posts, and snowload rail washers are used to help prevent the bolt head from pulling through the rail.) In other installations, it is normal to have the rail pull loose from the bolt head when impacted. Do not use rail washers within the limits of a guardrail terminal except at the end post where they are needed for anchorage of the rail.
- The use of curb in conjunction with beam guardrail is discouraged. If a curb is needed, the 3-inch-high curb is preferred. If necessary, the 4-inch-high extruded curb can be used behind the face of rail at any posted speed. The 6-inch-high extruded curb can be used at locations where the posted speed is 50 mph or below. When replacing extruded curb at locations where the posted speed is above 50 mph, use 3-inch-high or 4-inch-high curb. (See the *Standard Plans* for extruded curb designs.)
- When curb is used in conjunction with 31-inch-high Type 31 W-beam guardrail, it is acceptable to place a 6-inch-high curb at a maximum 7-inch offset outside the face of the rail at any posted speed.

Note: Coordinate with local WSDOT maintenance personnel before specifying that curb be placed outside the face of the guardrail (see the *Standard Plans* for placement details).

- Beam guardrail is usually galvanized and has a silver color. It can also be provided in weathering steel that has a brown or rust color. Along Scenic Byways, Heritage Tour Routes, state highways through national forests, or other designated areas, consider using weathering steel guardrail, colored terminals (powder-coated galvanized steel), and colored steel posts (galvanized weathering steel or powder-coated galvanized steel) to minimize the barrier's visual impact (see 1610.05).
- In areas where weathering steel will be used and the steel post options cannot be used because of stakeholder constraints, the wood post option may be used with justification (Design Decision Memo).
- There are new methods under development that may change the options for providing colored guardrail to meet the aesthetic criteria for Scenic Byway locations. The HQ Design Office will circulate guidance on these new developments as they are adopted as WSDOT policy.

(5) Terminals and Anchors

A guardrail anchor is needed at the end of a run of guardrail to develop tensile strength throughout its length. In addition, when the end of the guardrail is subject to head-on impacts, a crash-tested guardrail terminal is needed (see the *Standard Plans*).

(a) Buried Terminal (BT)

A buried terminal is designed to terminate the guardrail by burying the end in a backslope. The BT is the preferred terminal because it eliminates the exposed end of the guardrail.

The BT uses a Type 2 anchor to develop the tensile strength in the guardrail. The backslope needed to install a BT is to be 3H:1V or steeper and at least 4 feet in height above the roadway. The entire BT can be used within the length of need for backslopes of 1H:1V or steeper if the barrier remains at full height in relation to the roadway shoulder to the point where the barrier enters the backslope. For backslopes between 1H:1V and 3H:1V, design the length of need beginning at the point where the W-beam remains at full height in relation to the roadway shoulder—usually beginning at the point where the barrier crosses the ditch line. If the backslope is flatter than 1H:1V, provide a minimum 20-foot-wide by 75-foot-long distance behind the barrier and between the beginning length of need point at the terminal end to the mitigated object to be protected.

For new BT installations, use the Buried Terminal Type 2. Note: Previously, another BT option (the Buried Terminal Type 1) was an available choice. For existing situations, it is acceptable to leave this option in service as long as height requirements and other previous design criteria can still be met.

1. Buried Terminal Type 2

Flare the guardrail to the foreslope/backslope intersection using a flare rate that meets the criteria in 1610.05(4). Provide a 4H:1V or flatter foreslope into the face of the guardrail and maintain the full guardrail height to the foreslope/backslope intersection in relation to a 10H:1V line extending from edge of shoulder breakpoint. (See the *Standard Plans* for details.)

(b) Nonflared Terminal

If a BT terminal cannot be installed as described above, consider a nonflared terminal (see Exhibit 1610-12a). For Type 31 guardrail systems, there are currently two acceptable sole source proprietary designs: the ET-31 and the SKT-SP-MGS. These systems use W-beam guardrail with a special end piece that fits over the end of the guardrail. Steel posts are used throughout the length of the terminal. When hit head on, the end piece is forced over the rail and either flattens or bends the rail and then forces it away from the impacting vehicle.

Both the SKT-SP-MGS and the ET-31 terminals include an anchor for developing the tensile strength of the guardrail. The length of need begins at the third post for both terminals. Both of these terminals are available in two designs, which are based on the posted speed of the highway. For highways with a posted speed of 45 mph or above, use the ET-31 (TL3) or the SKT-SP-MGS (TL3) terminal. For lower-speed highways (a posted speed of 40 mph or below), use the ET-31 (TL2) or SKT-SP-MGS (TL2).

While these terminals do not need to have an offset at the end, a flare is recommended so that the end piece does not protrude into the shoulder. These terminals may have a 2-foot offset to the first post. Four feet of widening is needed at the end posts to properly anchor the system. When widening includes an embankment, fill material will be necessary for optimum terminal performance. (See the *Standard Plans* for widening details.)

When the entire barrier run is located farther than 12 feet beyond the shoulder break point and the slopes are greater than 10H:1V and 6H:1V or flatter, additional embankment at the terminal is not needed.

No snowload rail washers are allowed within the limits of these terminals.

When a Beam Guardrail Type 1 nonflared terminal is needed, two sole source proprietary terminals, the ET-PLUS or the Sequential Kinking Terminal (SKT), may be used (see Exhibit 1610-12b). Both of these Type 1 barrier terminals are available in two designs based on the posted speed of the highway. The primary difference in these designs is the length of the terminal. For highways with a posted speed of 45 mph or above, use the 50-foot-long ET PLUS TL3 or the SKT 350 terminal. For lower-speed highways (a posted speed of 40 mph or below), use the 25-foot-long ET PLUS TL2 or SKT-TL2.

The FHWA has granted approval to use the above sole source nonflared proprietary terminals without justification.

Note: Approved shop drawings for terminals can be found by accessing the following website: www.wsdot.wa.gov/design/policy/trafficbarriers.htm

(c) Flared Terminal

WSDOT does not use a flared terminal system for the Type 31 system. However, if a flared terminal is needed for other applications, there are currently two acceptable sole source proprietary designs: the Slotted Rail Terminal (SRT) and the Flared Energy Absorbing Terminal (FLEAT). Both of these designs include an anchor for developing the tensile strength of the guardrail. The length of need begins at the third post for both flared terminals.

1. The SRT uses W-beam guardrail with slots cut into the corrugations and posts throughout the length of the terminal. The end of the SRT is offset from the tangent guardrail run by the use of a parabolic flare. When struck head on, the first two posts are designed to break away, and the parabolic flare gives the rail a natural tendency to buckle, minimizing the possibility of the guardrail end entering the vehicle. The buckling is facilitated by the slots in the rail. The remaining posts provide strength to the system for redirection and deceleration without snagging the vehicle. The SRT has a 4 foot offset of the first post.

The SRT terminal can be supplied with wood or steel posts. Match the type of SRT posts with those of the longitudinal barrier run to which the terminal will be connected.

2. The FLEAT uses W-beam guardrail with a special end piece that fits over the end of the guardrail and posts. The end of the FLEAT is offset from the tangent guardrail run by the use of a straight flare. When struck head on, the end piece is forced over the rail, bending the rail and forcing it away from the impacting vehicle.

Note: Approved shop drawings for terminals can be found by accessing the following website: www.wsdot.wa.gov/design/policy/trafficbarriers.htm

The FLEAT is available in two designs based on the posted speed of the highway. For highways with a posted speed of 45 mph or above, use a FLEAT 350, which has a 4-foot offset at the first post. For lower-speed highways (a posted speed of 40 mph or below), use a FLEAT TL-2, which has a 1 foot-8-inch offset at the first post.

The FLEAT terminal can be supplied with wood or steel posts. Match the type of FLEAT posts with those of the longitudinal barrier run to which the terminal will be connected.

When a flared terminal is specified, it is critical that the embankment quantity also be specified so that the area around the terminal can be constructed as shown in the *Standard Plans*.

When the entire barrier run is located greater than 12 feet beyond the shoulder break point and the slopes are greater than 10H:1V and 6H:1V or flatter, additional embankment at the terminal is not needed.

Snowload rail washers are not allowed within the limits of these terminals.

The FHWA has granted approval to use the SRT and the FLEAT sole source proprietary flared terminals without justification.

(d) Terminal Evolution Considerations

Some currently approved terminals have been in service for a number of years. During this time, there have been minor design changes. However, these minor changes have not changed the devices' approval status. Previous designs for these terminals may remain in place. (For guidance on BCT terminals, see 1610.04(1).)

Note: If questions arise concerning the current approval status of a device, contact the HQ Design Office for clarification when replacement is being considered.

(e) Other Anchor Applications

Use the Type 10 anchor to develop the tensile strength of the guardrail on the end of Type 31 guardrail runs where a crash-tested terminal is not needed. The Type 1 or Type 4 anchor is used for older Beam Guardrail Type 1 where a crash-tested terminal is not needed. Use the Type 5 anchor with the Weak Post Intersection Design (see 1610.06(7)(b), Cases 12 and 13). Use the Type 7 anchor to develop tensile strength in the middle of a guardrail run when the guardrail curves and weak posts are used (see 1610.06(7)(b), Cases 9, 12, and 13).

The old Type 3 anchor was primarily used at bridge ends (see Exhibit 1610-5). This anchor consisted of a steel pipe mounted vertically in a concrete foundation. Bridge approach guardrail was then mounted on the steel pipe.

- On one-way highways, these anchors were usually positioned so that neither the anchor nor the bridge rail posed a snagging potential. When these cases are encountered, the anchor may remain in place if a stiffened transition section is provided at the connection to the post.
- On two-way highways, the anchor may present a snagging potential. In these cases, install a connection from the anchor to the bridge rail if the offset from the bridge rail to the face of the guardrail is 1 foot 6 inches or less. If the offset is greater than 1 foot 6 inches, remove the anchor and install a new transition and connection.

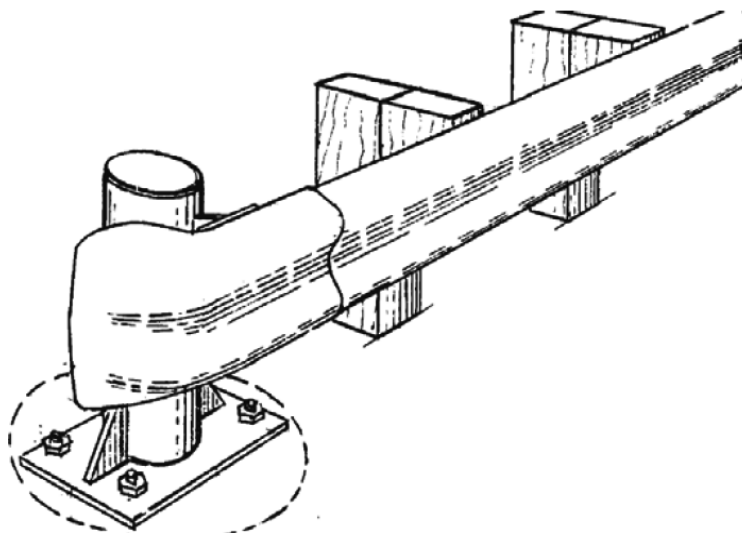

Old Type 3 Anchor
Exhibit 1610-5

Locations where crossroads and driveways cause gaps in the guardrail create situations for special consideration. Elimination of the need for the barrier is the preferred solution. Otherwise, a barrier flare might be needed to provide sight distance. If the slope is 2H:1V or flatter and there are no fixed features on or at the bottom of the slope, a terminal can be used to end the rail (see Chapters 1310 and 1340 for additional sight distance guidance). Place the anchor of this installation as close as possible to the road approach radius PC.

(6) Transitions and Connections

When there is an abrupt change from one barrier type to a more rigid barrier type, a vehicle hitting the more flexible barrier is likely to be caught in the deflected barrier pocket and directed into the more rigid barrier. This is commonly referred to as “pocketing.” A transition stiffens the more flexible barrier by decreasing the post spacing, increasing the post size, and using stiffer beam elements to eliminate the possibility of pocketing.

When connecting beam guardrail to a more rigid barrier or a structure, or when a rigid object is within the deflection distance of the barrier, use the transitions and connections that are shown in Exhibits 1610-6 and 1610-9 and detailed in the *Standard Plans*. The transition pay item includes the connection.

Condition	Connection
Unrestrained concrete barrier	A
Rigid, rigid anchored, untapered safety shape bridge rails or barriers ^[1]	B
Bridge rails with curbs 9 inches or less in width	B
Bridge rails with curbs between 9 and 18 inches wide	C
Vertical walls or tapered safety shape barrier ^[1]	D
Note: [1] New safety shape bridge rails are designed with the toe of the barrier tapered so that it does not project past the face of the approach guardrail.	

Guardrail Connections

Exhibit 1610-6

(7) Guardrail Placement Cases

The *Standard Plans* contains placement cases that show beam guardrail elements needed for typical situations. For some applications, the *Standard Plans* provides options for both Type 1 and Type 31 guardrail for similar installations. For new installations, use the appropriate Type 31 placement option. Additional placement cases incorporate other combinations of barrier types.

(a) Beam Guardrail Type 31 Placements (for new installations)

- **Case 1-31** is used where there is one-way traffic. It uses a crash-tested terminal on the approach end and a Type 10 anchor on the trailing end.

- **Case 2-31** is used where there is two-way traffic. A crash-tested terminal is used on both ends.
- **Case 3-31** is used at railroad signal supports on one-way or two-way roadways. A terminal is used on the approach end, but usually cannot be used on the trailing end because of its proximity to the railroad tracks. If there is a history of crossover accidents, consider additional protection such as an impact attenuator.
- **Case 4-31** is used where guardrail on the approach to a bridge is to be shifted laterally to connect with the bridge rail. A terminal is used on the approach end and a transition is needed at the bridge end. A curve in the guardrail is shown to shift it to the bridge rail. However, the length of the curve is not critical. The criterion is to provide a smooth curve that is not more abrupt than the allowable flare rate (see Exhibit 1610-3).
- **Case 5-31** is a typical bridge approach where a terminal and a transition are needed.
- **Case 6** is used on bridge approaches where opposing traffic is separated by a median that is 36 feet or wider. This case is designed so that the end of the guardrail will be outside the Design Clear Zone for the opposing traffic.
- **Case 10 (A-31, B-31, and C-31)** is used at roadside fixed features (such as bridge piers) when 3 or more feet are available from the face of the guardrail to the feature. The approach end is the same for one-way or two-way traffic. Case 10A-31 is used with two-way traffic; therefore, a terminal is needed on the trailing end. Case 10B-31 is used for one-way traffic when there is no need to extend guardrail past the bridge pier and a Type 10 anchor is used to end the guardrail. Case 10C-31 is used for one-way traffic when the guardrail will extend for a distance past the bridge pier.
- **Case 11 (A-31, B-31, and C-31)** is used at roadside fixed features (such as bridge piers) when the guardrail is to be placed within 3 feet of the feature. Since there is no room for deflection, the rail in front of the feature is to be considered a rigid system and a transition is needed. The trailing end cases are the same as described for Case 10.
- **Beam Guardrail Type 31 (12'6", 18'9", or 25' Span)** is used when it is necessary to omit one, two, or three posts. This application is typically used when guardrail is installed over drainage structures but may have other applications if adequate deflection distance is present. Three CRT posts are provided on each end of the omitted post(s).
- **Guardrail Placement Strong Post – Type 31** is the “Strong Post Intersection Design for Type 31 barrier” that provides a stiff barrier. This design is used at crossroads or road approaches where a barrier is needed and where the length of need cannot be achieved using standard components such as standard longitudinal barrier runs, transitions, and terminals.

Note: Some placement cases for use with Beam Guardrail Type 31 are currently under development. As plans become available, they will be housed in the HQ Design Standards (Plan Sheet Library) until they become Standard Plans (www.wsdot.wa.gov/design/standards/plansheet).

(b) Additional Placement Cases (typically for existing installations)

- **Case 1** is used where there is one-way traffic. It uses a crash-tested terminal on the approach end and a Type 4 anchor on the trailing end.
- **Case 2** is used where there is two-way traffic. A crash-tested terminal is used on both ends. When flared terminals are used on both ends, use a minimum of 25 feet of guardrail between the terminal limits when feasible.
- **Case 3** is used at railroad signal supports on one-way or two-way roadways. A terminal is used on the approach end, but usually cannot be used on the trailing end because of its proximity to the railroad tracks. If there is a history of crossover accidents, consider additional protection such as an impact attenuator.
- **Case 4** is used where guardrail on the approach to a bridge is to be shifted laterally to connect with the bridge rail. A terminal is used on the approach end and a transition is needed at the bridge end. A curve in the guardrail is shown to shift it to the bridge rail. However, the length of the curve is not critical. The criterion is to provide a smooth curve that is not more abrupt than the allowable flare rate (see Exhibit 1610-3).
- **Case 5** is a typical bridge approach where a terminal and a transition are needed.
- **Case 6** is used on bridge approaches where opposing traffic is separated by a that is 36 feet or wider. This case is designed so that the end of the guardrail will be outside the Design Clear Zone for the opposing traffic.
- **Cases 7 and 8** are used with beam guardrail median barrier when median fixed features such as bridge piers are encountered. A transition is needed on the approach end for each direction, and the flare rate is not to be more abrupt than the allowable flare rate (see Exhibit 1610-3).
- **Case 9 (A, B, and C)** is used on bridge approaches where opposing traffic is separated by a median less than 36 feet wide. This design, called a “Bull Nose Terminal,” treats both bridge ends and the opening between the bridges. The “nose” is designed to collapse when struck head on, and the ribbon strength of the rail brings the vehicle to a controlled stop. Type 7 anchors are installed on each side of the nose to develop the ribbon strength. Since an impacting vehicle might penetrate into the system, it is critical that no fixed feature be located within the first 65 feet of the system.
- **Case 10 (A, B, and C)** is used at roadside fixed features (such as bridge piers) when 3 or more feet are available from the face of the guardrail to the object. The approach end is the same for one-way or two-way traffic. Case 10A is used with two-way traffic; therefore, a terminal is needed on the trailing end. Case 10B is used for one-way traffic when there is no need to extend guardrail past the bridge pier and a Type 4 anchor is used to end the guardrail. Case 10C is used for one-way traffic when the guardrail will extend for a distance past the bridge pier.
- **Case 11 (A, B, and C)** is used at roadside fixed features (such as bridge piers) when the guardrail is to be placed within 3 feet of the object. Since there is no room for deflection, the rail in front of the feature is to be considered a rigid system and a transition is needed. The trailing end cases are the same as described for Case 10.

- **Cases 12 and 13** are called “Weak Post Intersection Designs.” They are used where an intersection design needs a gap in the guardrail or there is not adequate space for a bridge approach installation that includes a transition, a terminal, or both. These placements are designed to collapse when hit at the nose, and the ribbon strength of the rail brings the vehicle to a stop. A Type 7 anchor is used to develop the ribbon strength. These designs include a Type 5 transition for connection with bridge rail and a Type 5 anchor at the other end of the rail. The Type 5 anchor is not a breakaway anchor and therefore can typically be used only in situations where a crash-tested terminal is not needed; for example, where slow-moving vehicles are anticipated, such as some side roads and driveways.

Since an impacting vehicle might penetrate into the system, it is critical that no fixed feature be located within the clear area shown in the Standard Plans. The 25 feet of barrier length beyond the PC along the side road are critical for the operation of this system.

These designs were developed for intersections that are approximately perpendicular. Evaluate installation on skewed intersections on a case-by-case basis. Use the Case 22 placement if it is not feasible to install this design according to the *Standard Plans*.

- **Case 14** shows the approach rail layout for a Service Level 1 bridge rail system. Type 20 guardrail is used on the approach and no transition is needed between the Type 20 guardrail and the Service Level 1 bridge rail since they are both weak post systems. A Type 6 transition is used when connecting the Type 20 to a strong post guardrail or a terminal.
- **Case 15** is used to carry guardrail across a box culvert where there is insufficient depth to install standard posts for more than 17 feet 8 inches. This design uses steel posts anchored to the box culvert to support the rail. Newer designs—Cases 19, 20, and 21—have replaced this design for shorter spans.
- **Cases 16 and 17** are similar to Cases 1 and 2, except that they flare the rail and terminal as far from the road as possible and reduce the length of need.
- **Case 18** is used on the trailing end of bridge rail on a one-way roadway. No transition is needed.
- **Case 19 (A and B)** is used where it is not possible to install a post at the 6-foot-3-inch spacing. This design omits one post (resulting in a span of 11 feet 6 inches, which is consistent with a post spacing of 12 feet 6 inches) and uses nested W-beam to stiffen the rail. The cases differ by the location of the splice. No cutting of the rail or offsetting of the splices is needed or desirable.
- **Case 20** is similar to Cases 19A and 19B, except that it allows for two posts to be omitted, which results in a span consistent with post spacing of 18 feet 9 inches.
- **Case 21** has a similar intent as Cases 19A, 19B, and 20 in that it allows for the omission of posts to span an obstruction. This design uses CRT posts with additional post blocks for three posts before and after the omitted posts. The design allows for three posts to be omitted, which results in a span consistent with a post spacing of 25 feet.
- **Case 22** is the “Strong Post Intersection Design” that provides a stiff barrier. This design is to be used as a last resort at crossroads or road approaches where a barrier is needed and there isn’t a clear area behind the nose or minimum distances for a “Weak Post Intersection Design” (see Cases 12 and 13).

Note: Some placement cases for use with Beam Guardrail Type 31 are currently under development. As plans become available, they will be housed in the HQ Design Standards (Plan Sheet Library) until they become Standard Plans (www.wsdot.wa.gov/design/standards/plansheet).

1610.07 Cable Barrier

Cable barrier is a flexible barrier system that can be used on a roadside or as a median barrier. It is used primarily in medians and is preferred for many installations due in part to its high benefit-to-cost ratio. Some of the advantages of cable barrier are:

- It provides effective vehicle containment and redirection while imposing the lowest deceleration forces on the vehicle's occupant(s).
- It reduces the severity of collisions, which is of significant importance on high-speed facilities.
- After it is struck, it has a tendency not to redirect vehicles back into traffic, which can help reduce the frequency of secondary collisions.
- It can often be placed on existing facilities without the delay of extended environmental permitting and the expense of complex highway reconstruction that might be needed for other barrier system choices.
- It has advantages in heavy snowfall areas because it has minimal potential to create snowdrifts.
- In crucial wildlife habitats, it can aid in some types of animal movements.
- It does not present a visual barrier, which may make it desirable on Scenic Byways (see 1610.05).
- The effort (time and materials) needed to maintain and repair cable barrier systems is much less than the effort needed for a W-beam system.

Deflection is a consideration in narrower median areas and in many urban and other limited-width situations. Use of cable barrier in these situations may not be possible or may require special designs.

For new installations, use four-cable high-tension (H.T.) cable barrier systems, which are available from several manufacturers.

(1) High-Tension Cable Barrier Placement

For typical median applications with slopes between 10H:1V and 6H:1V (see Exhibit 1610-13a), the following apply:

- Cable barrier may be installed in the center of the ditch.
- The cable barrier may be offset from the ditch centerline a maximum of 1 foot in either direction.
- Avoid installing cable barrier within a 1-foot to 8-foot offset from the ditch centerline.
- Install cable as needed between an 8-foot offset from the ditch centerline and the slope breakpoint.

- For median shoulder applications of single-runs of cable median barrier with at least 13 feet from edge of the nearest traveled lane to the slope breakpoint, place the cable median barrier at least 1 foot in front of the slope breakpoint. Any four-cable high-tension barrier system may be used in this location (see Exhibit 1610-13a).
- Typically, double-runs of cable median barrier are not needed. However, if this type of application is used on shoulders with at least 11 feet from edge of the nearest traveled lane to the slope breakpoint, place the cable median barrier at least 1 foot in front of the slope breakpoint. Any approved four-cable high-tension barrier system may be used in this location.
- In some situations with cable barrier installations in medians, it is advantageous to terminate a run on one side of the median and begin an adjacent run on the opposite side. In this type of application, it is important to provide adequate cable barrier overlap distance between the two runs. For placement guidance, see Exhibit 1610-13c.

Narrow medians provide little space for maintenance crews to repair or reposition the barrier. Wherever site conditions permit, provide at least 14 feet of clearance from the adjacent lane edge to the cable barrier.

For non-median shoulder applications, cable barrier can be installed up to 1 foot in front of slope breakpoints as steep as 2H:1V. Cable barrier is the barrier option that can be placed on a sideslope steeper than 10H:1V within the 12-foot area immediately beyond the slope breakpoint. Do not place this barrier on a sideslope steeper than 6H:1V. Exhibit 1610-13b shows the placement of cable barrier for shoulder applications.

Note: There are approved high-tension cable barrier systems that can be placed on slopes as steep as 4H:1V. The use of these systems requires special placement considerations. Contact the HQ Design Office for guidance when selecting these systems.

(2) High-Tension Cable Barrier Deflection Distances

Depending on the system and post spacing, deflection distances for high-tension barrier systems may range from approximately 6 to 12 feet. Provide deflection distance guidance in the contract documents. (See Exhibits 1610-13a and 13b for placement details.)

Note: There are new high-tension cable barrier systems under development that may change selection and placement criteria. The HQ Design Office will circulate guidance on these new developments as they are adopted as WSDOT policy.

(3) High-Tension Cable Barrier Termination

- It is possible to terminate high-tension cable barrier systems by connecting directly to beam guardrail runs and also to use a separate anchorage system. Designers should review field conditions, check local maintenance personnel needs, and then specify the required connection option in the contract documents. If a separate anchorage system is used, refer to Exhibit 1610-13c for placement guidance.
- When cable barrier is to be connected to a more rigid barrier, a transition section is needed. Contact the HQ Design Office for further details.

(4) High-Tension Cable Barrier Height Criteria

Select a high-tension four-cable barrier system with a height to the center of the top cable of not less than 35 inches and a height to the center of the bottom cable not greater than 19 inches.

Note: There are high-tension cable barrier systems under development that may change selection and placement criteria. The HQ Design Office will circulate guidance on these new developments as they are adopted as WSDOT policy.

1610.08 Concrete Barrier

Concrete barriers are rigid, rigid anchored, or unrestrained rigid systems. Commonly used in medians, they are also used as shoulder barriers. These systems are stiffer than beam guardrail or cable barrier, and impacts with these barriers tend to be more severe.

Light standards mounted on top of concrete median barrier must not have breakaway features. (See the concrete barrier light standard section in the *Standard Plans*.)

When concrete barrier is considered for use in areas where drainage and environmental issues (such as stormwater, wildlife, or endangered species) might be adversely impacted, contact the HQ Hydraulics Office and the appropriate environmental offices for guidance.

(1) Concrete Barrier Shapes

Concrete barriers use a single-slope or safety shape (New Jersey or F-Shape) to redirect vehicles while minimizing vehicle vaulting, rolling, and snagging. A comparison of these barrier shapes is shown in Exhibit 1610-7.

The single-slope barrier face is the recommended option for embedded rigid concrete barrier applications.

Note: There are new precast concrete barrier systems under development that may change future selection and placement criteria. The HQ Design Office will circulate guidance on these new developments as they are adopted as WSDOT policy.

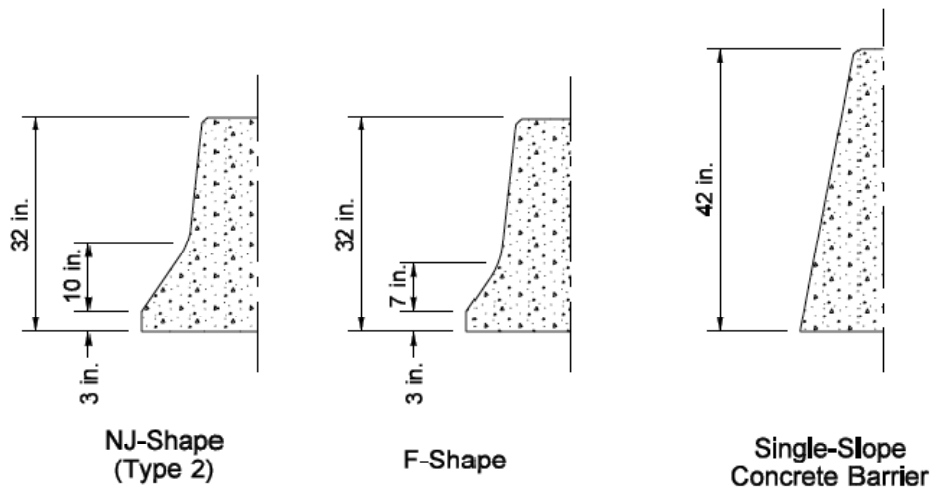

Concrete Barrier Shapes
Exhibit 1610-7

When the single-slope or F-Shape face is used on structures, and precast barrier is selected for use on the approaches, a cast-in-place transition section is needed so that no vertical edges of the barrier are exposed to oncoming traffic. For details on bridge rail designs, see the *Bridge Design Manual*.

For aesthetic reasons, avoid changes in the shape of the barrier face within a project or corridor.

(a) New Jersey Shape Barrier

The New Jersey shape face is primarily used on precast concrete barrier.

Concrete barrier Type 2 (see the *Standard Plans*) is a precast barrier that has the New Jersey shape on two sides and can be used for both median and shoulder installations. This barrier is 2 feet 8 inches in height, which includes 3 inches for future pavement overlay.

The cost of precast Type 2 barrier is significantly less than the cost of the cast-in-place barriers. Therefore, consider the length of the barrier run and the deflection needs to determine whether transitioning to precast Type 2 barrier is desirable. If precast Type 2 barrier is used for the majority of a project, use the New Jersey face for small sections that need cast-in-place barrier, such as for a light standard section.

Concrete barrier Type 4 is also a precast, single-faced New Jersey shape barrier. These units are not freestanding and are to be placed against a rigid structure or anchored to the pavement. If Type 4 barriers are used back to back, consider filling any gap between them to prevent tipping.

Concrete barrier Type 5 is a precast barrier that has a single New Jersey face and is intended for use at bridge ends where the flat side is highly visible. Both Type 2 and Type 5 designs are freestanding, unanchored units connected with steel pins through wire rope loops. For permanent installation, this barrier is placed on a paved surface and a 2-foot-wide paved surface is provided beyond the barrier for its displacement during impact (see Chapter 1230).

Precast barrier can be anchored where a more rigid barrier is needed. (Anchoring methods are shown in the *Standard Plans*.) The Type 1 and Type 2 anchors are for temporary installations on a rigid pavement. Type 3 anchors can be used in temporary or permanent installations on an asphalt pavement. Consult the HQ Bridge and Structures Office for details when anchoring permanent precast concrete barrier to a rigid pavement.

Precast barrier used on the approach to bridge rail is to be connected to the bridge rail by installing wire rope loops embedded 1 foot 3 inches into the bridge rail with epoxy resin.

Place unrestrained (unanchored) precast concrete barrier on foundation slopes of 5% or flatter. In difficult situations, a maximum slope of 8% may be used. Keep the slope of the area between the edge of the shoulder and the face of the traffic barrier as flat as possible. The maximum slope is 10H:1V (10%).

(b) Single-Slope Barrier

The single-slope concrete barrier can be cast in place, slipformed, or precast. The most common construction technique for this barrier has been slipforming, but some precast single-slope barrier has been installed. The primary benefit of using precast barrier is that it can be used as temporary barrier during construction and then reset into a permanent location.

Single-slope barrier is considered a rigid system regardless of the construction method used. For new installations, the minimum height of the barrier above the roadway is 2 feet 10 inches, which allows 2 inches for future overlays. The minimum total height of the barrier section is 3 feet 6 inches, with a minimum of 3 inches embedded in the roadway wearing surface. This allows for use of the 3 foot-6-inch barrier between roadways with grade separations of up to 5 inches. A grade separation of up to 10 inches is allowed when using a 4-foot-6-inch barrier section, as shown in the *Standard Plans*. The barrier is to have a depth of embedment equal to or greater than the grade separation. Contact the HQ Bridge and Structures Office for grade separations greater than 10 inches.

(c) Low-Profile Barrier

Low-profile barrier designs are available for median applications where the posted speed is 45 mph or below. These barriers are normally used in urban areas. They are typically 18 to 20 inches high and offer sight distance benefits. For barrier designs, terminals, and further details, contact the HQ Design Office.

(2) High-Performance Concrete Barrier

High-Performance Concrete Barrier (HP Barrier) is a rigid 42-inch-high barrier, above the roadway surface, designed to function more effectively during heavy-vehicle collisions. This taller barrier may also offer the added benefits of reducing headlight glare and reducing noise in surrounding environments. HP Barrier is generally considered single-slope barrier. (See the *Standard Plans* for barrier details.) For additional available shapes, contact the HQ Design Office.

For new/reconstruction, use HP Barrier in freeway medians of 22 feet or less. Also, use HP Barrier on Interstate or freeway routes where accident history suggests a need or where roadway geometrics increase the possibility of larger trucks hitting the barrier at a high angle (for example, on-ramps for freeway-to-freeway connections with sharp curvature in the alignment).

Consider the use of HP Barrier at other locations such as nonfreeway narrow medians, near highly sensitive environmental areas, near densely populated areas, over or near mass transit facilities, or on vertically divided highways.

(3) Concrete Barrier Terminals

Whenever possible, bury the end of the concrete barrier in the backslope. The backslope needed to bury the end is to be 3H:1V or steeper and at least 4 feet in height above the roadway. Flare the concrete barrier into the backslope using a flare rate that meets the criteria in 1610.05(4). Provide a 10H:1V or flatter foreslope into the face of the barrier and maintain the full barrier height to the foreslope/backslope intersection. This might create the need to fill ditches and install culverts in front of the barrier face.

The 7-foot-long precast concrete terminal end section for concrete barrier Type 2 and the 10- to 12-foot single-slope barrier terminal may be used:

- Outside the Design Clear Zone.
- On the trailing end of the barrier when it is outside the Design Clear Zone for opposing traffic.
- On the trailing end of one-way traffic.
- Where the posted speed is 25 mph or below.

Another available end treatment for Type 2 barriers is a precast or cast-in-place tapered terminal section with a minimum length of 48 feet and a maximum length of 80 feet. It is used infrequently for special applications and is designed to be used for posted speeds of 35 mph or below. For details, contact the HQ Design Office or refer to the Plan Sheet Library: www.wsdot.wa.gov/design/standards/plansheet/

When the “Barrier Terminals and Transitions” column of a Design Matrix applies to a project, existing sloped-down concrete terminals that are within the Design Clear Zone are to be replaced when they do not meet the above criteria.

When the end of a concrete barrier cannot be buried in a backslope or terminated as described above, terminate the barrier using a guardrail terminal and transition or an impact attenuator (see Chapter 1620).

(4) Assessing Impacts to Wildlife

The placement of concrete barriers in locations where wildlife frequently cross the highway can influence traffic safety and wildlife mortality. When wildlife encounter physical barriers that are difficult to cross, they often travel parallel to those barriers. With traffic barriers, this means that they often remain on the highway for a longer period, increasing the risk of wildlife/vehicle collisions or vehicle/vehicle collisions as motorists attempt avoidance.

Traffic-related wildlife mortality may play a role in the decline of some species listed under the Endangered Species Act. To address public safety and wildlife concerns, see Exhibit 1610-8 to assess whether concrete barrier placement needs to have an evaluation by the HQ Environmental Services Office to determine its effect on wildlife. Conduct this evaluation early in the project development process to allow adequate time for discussion of options.

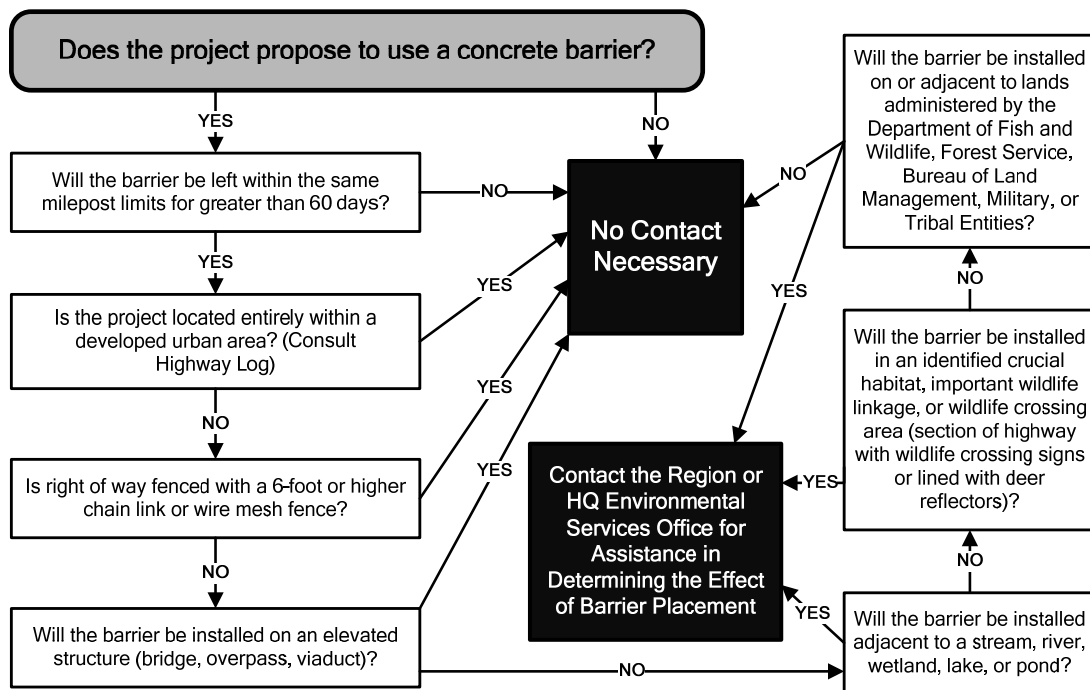

Concrete Barrier Placement Guidance: Assessing Impacts to Wildlife
 Exhibit 1610-8

(5) Assessing Impacts to Stormwater and Wetlands

In locations where medians or roadsides are used for drainage, the retention of stormwater or the existence of wetlands can influence the choice and use of barrier systems. For example, the placement of concrete barrier and beam guardrail in many of these cases may create the need for additional impervious material, which can result in complete retrofit and reconstruction of the existing systems. When water is drained, stored, or treated, and where wetlands exist, the ability to provide alternative facilities that replace the functions of the existing ones may be nonexistent or prohibitively expensive to provide elsewhere.

To address public safety, stormwater, and wetland concerns, assess whether concrete barrier or beam guardrail placement will cause the need for an evaluation by the HQ Environmental Services Office. Conduct this evaluation early in the project development process to allow adequate time for discussion of options.

1610.09 Special-Use Barriers

The following barriers may be used on designated Scenic Byway and Heritage Tour routes if funding can be arranged (see 1610.05 and Chapter 120).

(1) Steel-Backed Timber Guardrail

Steel-backed timber guardrails consist of a timber rail with a steel plate attached to the back to increase its tensile strength. There are several variations of this system that have passed crash tests. The nonproprietary systems use a beam with a rectangular cross section that is supported by either wood or steel posts. A proprietary (patented) system called the Ironwood Guardrail is also available. This system uses a beam with a round cross section and is supported by steel posts with a wood covering to give the appearance of an all-wood system from the roadway. The Ironwood Guardrail can be allowed as an alternative to the nonproprietary system. However, specifying this system exclusively needs approval by an Assistant State Design Engineer of a public interest finding for the use of a sole source proprietary item.

The most desirable method of terminating the steel-backed timber guardrail is to bury the end in a backslope, as described in 1610.06(5). When this type of terminal is not possible, use of the barrier is limited to highways with a posted speed of 45 mph or below. On these lower-speed highways, the barriers can be flared away from the traveled way and terminated in a berm outside the Design Clear Zone.

For details on these systems, contact the HQ Design Office.

(2) Stone Guardwalls

Stone guardwalls function like rigid concrete barriers but have the appearance of natural stone. These walls can be constructed of stone masonry over a reinforced concrete core wall or of simulated stone concrete. These types of barriers are designed to have a limited projection of the stones to help aid in the redirection characteristics of the barrier. The most desirable method of terminating this barrier is to bury the end in a backslope, as described in 1610.08(3). When this type of terminal is not possible, use of the barrier is limited to highways with a posted speed of 45 mph or below. On these lower-speed highways, the barrier can be flared away from the traveled way and terminated in a berm outside the Design Clear Zone.

For details on these systems, contact the HQ Design Office.

1610.10 Bridge Traffic Barriers

Bridge traffic barriers redirect errant vehicles and help to keep them from going over the side of the structure. (See the *Bridge Design Manual* for information regarding bridge barrier on new bridges and replacement bridge barrier on existing bridges.)

For new bridge rail installations, use a 2-foot-10-inch-high single-slope or a 2-foot-8-inch-high safety shape (F-Shape) bridge barrier. A transition is available to connect the New Jersey shape (Type 2 concrete barrier) and the F-Shape bridge barrier. (See the *Standard Plans* for further details.)

Use taller 3-foot-6-inch single-slope or safety shape bridge barriers on Interstate or freeway routes where accident history suggests a need or where taller barrier is required on approaching roadways with narrow medians, as defined in 1610.08(2). Also, consider taller 3-foot-6-inch barrier when geometrics increase the possibility of larger trucks hitting the barrier at a high angle (such as on-ramps for freeway-to-freeway connections with sharp curvature in the alignment).

For further guidance on bridges where high volumes of pedestrian traffic are anticipated, see Chapters 720, 1510, 1515, and 1520.

Approach barriers, transitions, and connections are usually needed on all four corners of bridges carrying two-way traffic and on both corners of the approach end for one-way traffic. (See 1610.06(6) for guidance on transitions.)

If the bridge barrier system does not meet the criteria for strength and geometrics, modifications to improve its redirection characteristics and its strength may be needed. The modifications can be made using one of the retrofit methods described below.

(1) Concrete Safety Shape

Retrofitting with a new concrete bridge barrier is costly and needs to have justification when no widening is proposed. Consult the HQ Bridge and Structures Office for design details and to determine whether the existing bridge deck and other superstructure elements are of sufficient strength to accommodate this bridge barrier system.

(2) Thrie Beam Retrofit

Retrofitting with thrie beam is an economical way to improve the strength and redirection performance of bridge barriers. The thrie beam can be mounted to steel posts or the existing bridge barrier, depending on the structural adequacy of the bridge deck, the existing bridge barrier type, the width of curb (if any), and the curb-to-curb roadway width carried across the structure.

The HQ Bridge and Structures Office is responsible for the design of thrie beam bridge barrier. Exhibit 1610-14 shows typical retrofit criteria. Contact the HQ Bridge and Structures Office for assistance with thrie beam retrofit design.

Consider the Service Level 1 (SL-1) system on bridges with wooden decks and for bridges with concrete decks that do not have the needed strength to accommodate the thrie beam system. Contact the HQ Bridge and Structures Office for information needed for the design of the SL-1 system.

A sidewalk reduction of up to 6 inches as a result of a three beam retrofit can be documented as a design exception.

The funding source for retrofit of existing bridge rail is dependent on the length of the structure. Bridge rail retrofit, for bridges less than 250 feet in length, or a total bridge rail length of 500 feet, is funded by the project (Preservation or Improvement). For longer bridges, the retrofit can be funded by the I-2 subprogram. Contact the HQ Program Development Office to determine whether funding is available.

1610.11 Other Barriers

(1) Dragnet

The Dragnet Vehicle Arresting Barrier consists of chain link or fiber net that is attached to energy absorbing units. When a vehicle hits the system, the Dragnet brings the vehicle to a controlled stop with limited damage. Possible uses for this device include the following:

- Reversible lane entrances and exits
- Railroad crossings
- Truck escape ramps (instead of arrester beds—see Chapter 1270)
- T-intersections
- Work zones
- Swing span bridges

For permanent installations, this system can be installed between towers that lower the unit into position when needed and lift it out of the way when it is no longer needed. For work zone applications, it is critical to provide deflection space for stopping the vehicle between the system and the work zone. For additional information on the Dragnet, contact the HQ Design Office.

1610.12 Documentation

For the list of documents required to be preserved in the Design Documentation Package and the Project File, see the Design Documentation Checklist:

☞ www.wsdot.wa.gov/design/projectdev/

Connecting W-Beam Guardrail to: Transitions and Connections		Transition Type*	Connection	
Bridge Rail	New Installation	20, 21	D	
	Existing Concrete	Concrete Parapet > 20 inches	20, 21, 4 ^[4]	Exhibit 1610-6
		Concrete Parapet < 20 inches	2, 4 ^[4]	Exhibit 1610-6
		Existing W-Beam Transition	2 ^{[1][5]} , 4 ^[4]	[1]
	Thrie Beam at Face of Curb ^[3]	Approach End	23	n/a
		Trailing End (two-way traffic only)	23	n/a
	Thrie Beam at Bridge Rail (curb exposed) ^[3]	Approach End	22	n/a
		Trailing End (two-way traffic only)	22	n/a
	Weak Post Intersection Design (see 1610.06(7)(b), Cases 12 & 13)		5	Exhibit 1610-6
Concrete Barrier	<u>Rigid & Rigid Anchored</u>	21	Exhibit 1610-6	
	Unrestrained	2, 4 ^[4]	A	
Weak Post Barrier Systems (Type 20 and 21)		6	n/a	
Rigid Structures such as Bridge Piers	New Installation (see Cases 11–31)	21	n/a	
	Existing W-Beam Transition	[2]	n/a	
Connecting Thrie Beam Guardrail to:		Transition Type*	Connection	
Bridge Rail or Concrete Barrier	New Installation (example: used with thrie beam bull nose)	1B	Exhibit 1610-6	

*Consult Section C of the *Standard Plans* for details on transition types.

Notes:

- [1] If work creates the need for reconstruction or resetting of the transition, upgrade as shown above. Raising the guardrail is not considered reconstruction. If the transition is not being reconstructed, the existing connection may remain in place. When Type 3 anchors are encountered, see 1610.06(5)(e) for guidance.
- [2] For new/reconstruction, use Case 11 (thrie beam). For existing Case 11 with W-beam, add a second W-beam rail element.
- [3] For Service Level 1 bridge rail, see 1610.06(7)(b), Case 14.
- [4] Use on highways with speeds 45 mph or below.
- [5] If existing transition has the needed guardrail height—three 10" x 10" (nominal) posts and three 6" x 8" (nominal) posts spaced 3'-1.5" apart—it is acceptable to nest existing single W-beam element transitions.

Transitions and Connections

Exhibit 1610-9

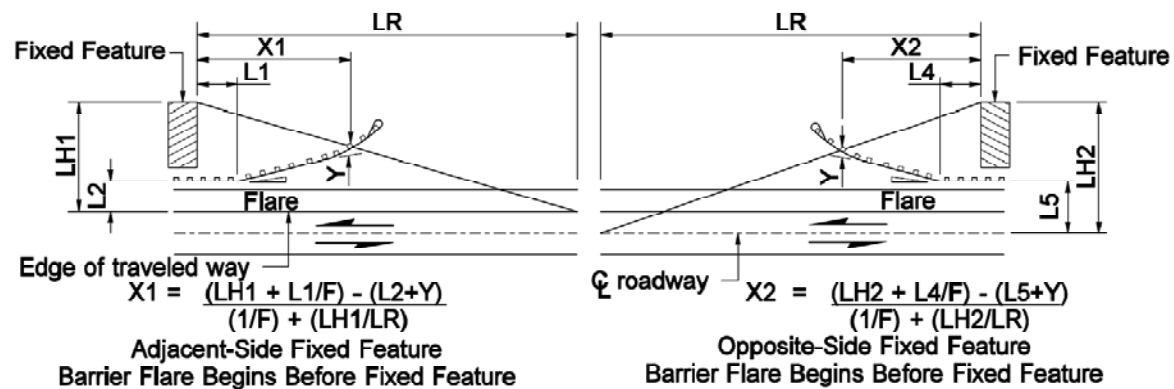
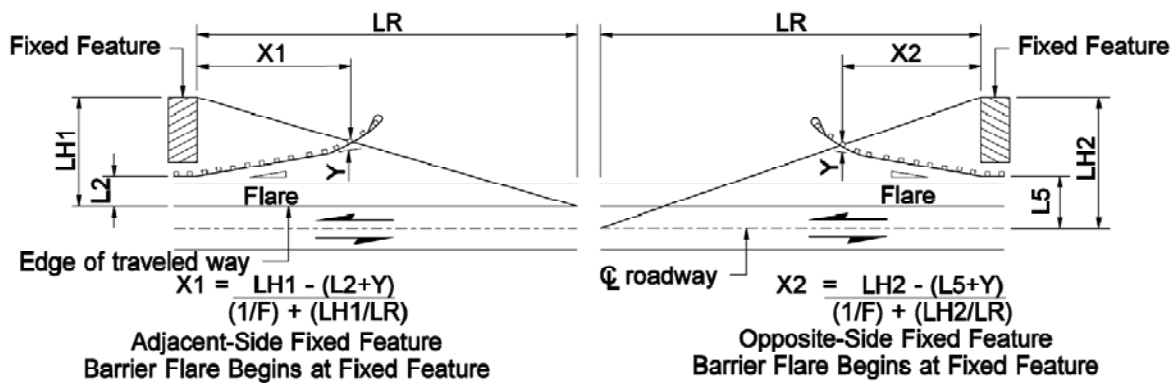
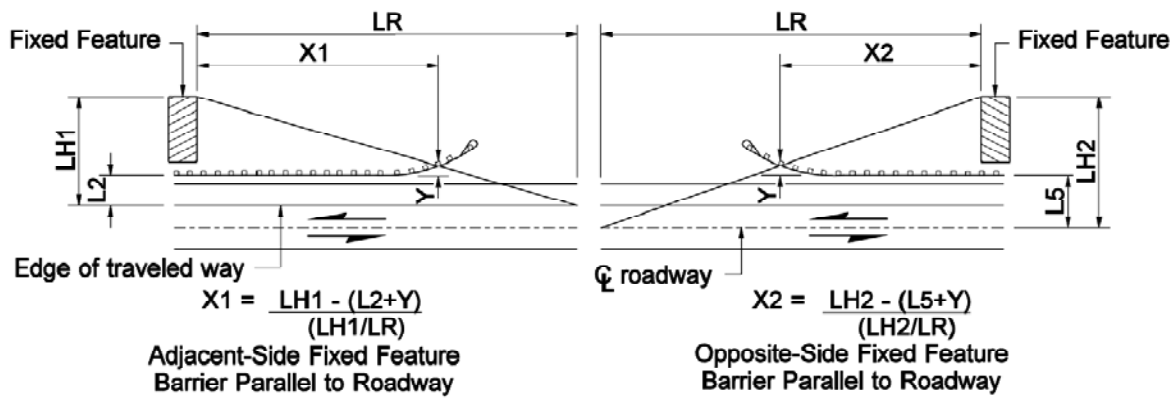

Note:

For supporting length of need equation factors, see Exhibit 1610-10b.

Barrier Length of Need on Tangent Sections

Exhibit 1610-10a

Posted Speed (mph)	Design Parameters						
	ADT				Barrier Type		
	Over 10,000	5,000 to 10,000	1,000 to 4,999	Under 1,000	Rigid & Rigid Anchored Barrier	Rigid Unrestrained Barrier	Semirigid Barrier
	LR (ft)	LR (ft)	LR (ft)	LR (ft)	F	F	F
65 & 70	460	395	345	295	20	18	15
60	360	295	260	230	18	16	14
55	310	260	230	195	16	14	12
50	260	215	180	165	14	12	11
45	245	195	165	150	12	11	10
40	215	180	150	130	11	10	9
35	185	155	130	115	11	10	9
30	165	135	115	105	11	10	9
25	150	125	105	95	11	10	9

- L1 = Length of barrier parallel to roadway from adjacent-side fixed feature to beginning of barrier flare. This is used if a portion of the barrier cannot be flared (such as a bridge rail and the transition).
- L2 = Distance from adjacent edge of traveled way to portion of barrier parallel to roadway.
- L4 = Length of barrier parallel to roadway from opposite-side fixed feature to beginning of barrier flare.
- L5 = Distance from centerline of roadway to portion of barrier parallel to roadway. Note: If the fixed feature is outside the Design Clear Zone when measured from the centerline, it may only be necessary to provide a crash-tested end treatment for the barrier.
- LH1 = Distance from outside edge of traveled way to back side of adjacent-side fixed feature. Note: If a fixed feature extends past the Design Clear Zone, the Design Clear Zone can be used as LH1.
- LH2 = Distance from centerline of roadway to back side of opposite-side fixed feature. Note: If a fixed feature extends past the Design Clear Zone, the Design Clear Zone can be used as LH2.
- LR = Runout length, measured parallel to roadway.
- X1 = Length of need for barrier to shield an adjacent-side fixed feature.
- X2 = Length of need for barrier to shield an opposite-side fixed feature.
- F = Flare rate value.
- Y = Offset distance needed at the beginning of the length of need.

Different end treatments need different offsets:

- For the SRT 350 and FLEAT 350, use Y = 1.8 feet.
- For evaluating existing BCTs, use Y = 1.8 feet.
- For the FLEAT TL-2, use Y = 0.8 feet.
- No offset is needed for the nonflared terminals or impact attenuator systems. Use Y = 0.
- Buried terminal end treatments are used with barrier flares and have no offset. Use Y = 0.

Barrier Length of Need

Exhibit 1610-10b

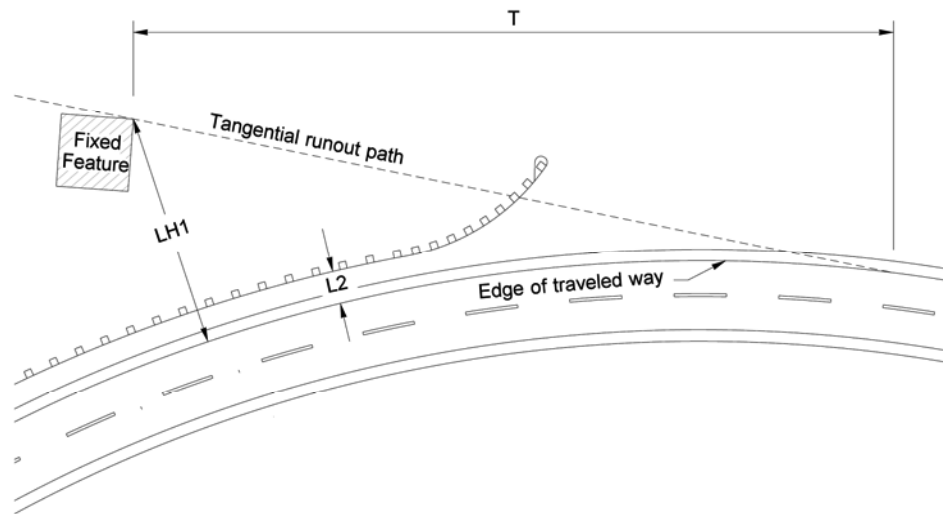

Notes:

- This is a graphical method for determining the length of need for barrier on the outside of a curve.
- On a scale drawing, draw a tangent from the curve to the back of the fixed feature. Compare T to LR from Exhibit 1610-10b and use the shorter value.
- If using LR, follow Exhibits 1610-10a and 10b.
- If using T, draw the intersecting barrier run to scale and measure the length of need

Barrier Length of Need on Curves
Exhibit 1610-10c

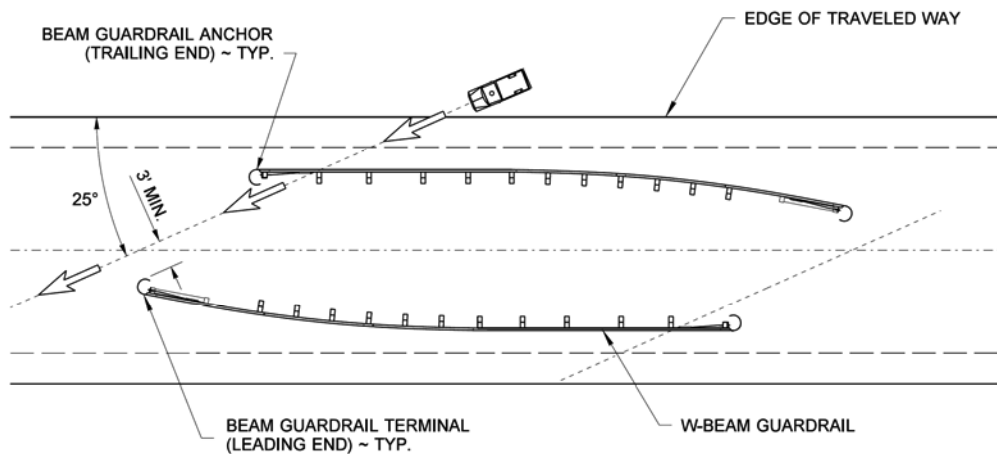

W-Beam Guardrail Trailing End Placement for Divided Highways
Exhibit 1610-10d

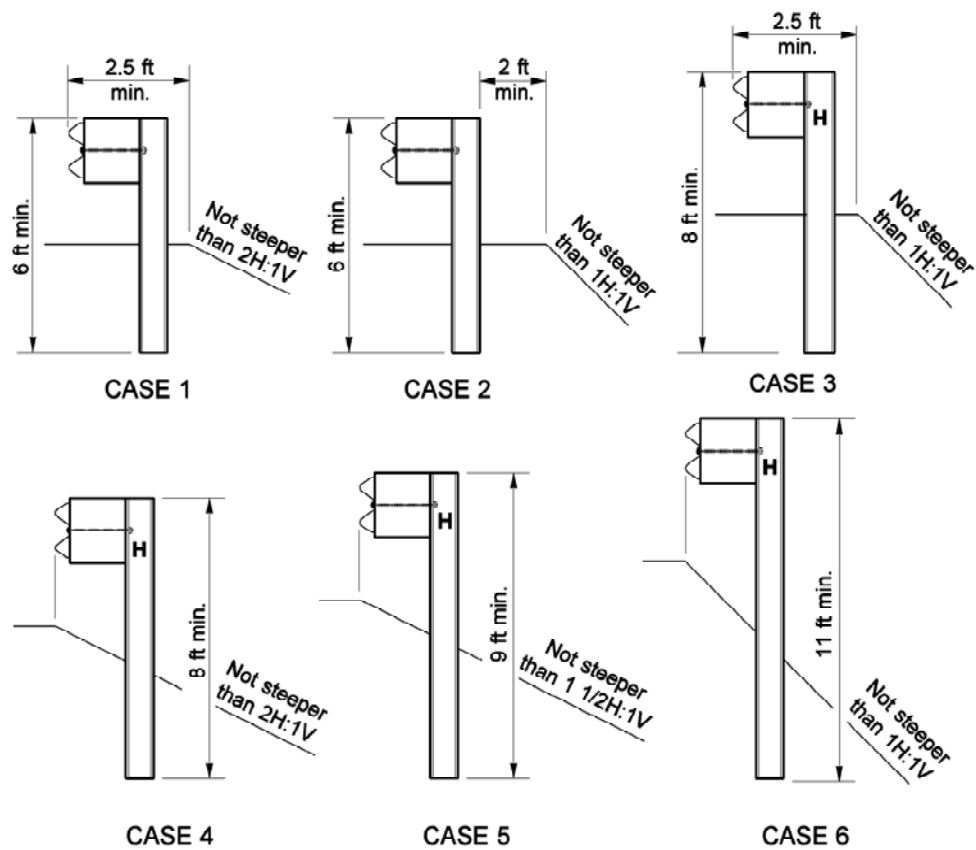

Type 31 Shown

Notes:

- Use Cases 1 and 3 when there is a 2.5-foot or greater shoulder widening from face of guardrail to the breakpoint.
- Use Case 2 when there is a 4.0-foot or greater shoulder widening from the face of the guardrail to the breakpoint.
- Use Cases 4, 5, and 6 when there is less than a 2.5-foot shoulder widening from face of guardrail to the breakpoint.

Beam Guardrail Post Installation*Exhibit 1610-11*

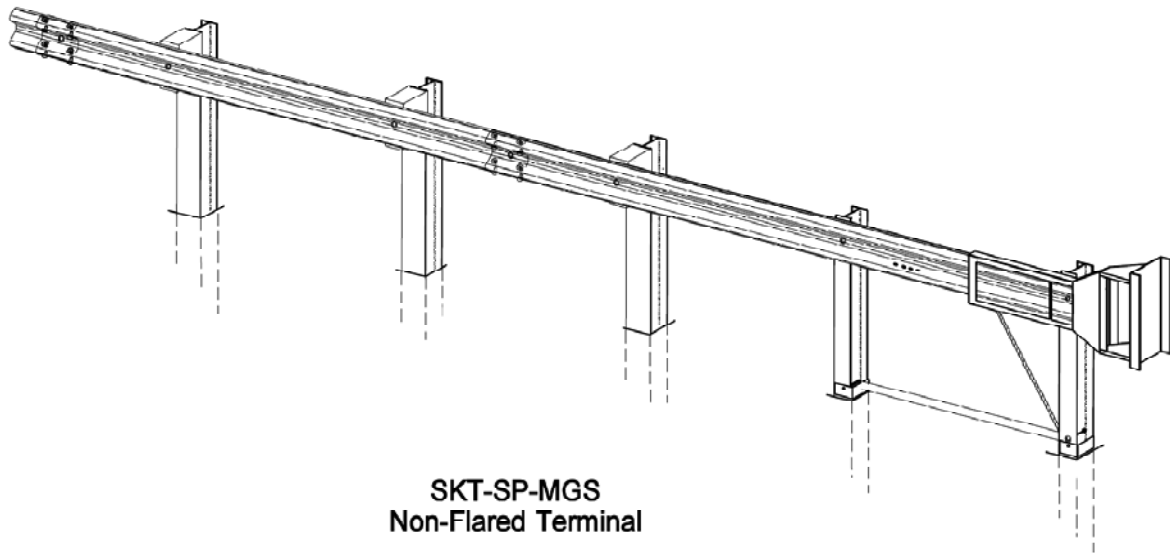

**SKT-SP-MGS
Non-Flared Terminal**

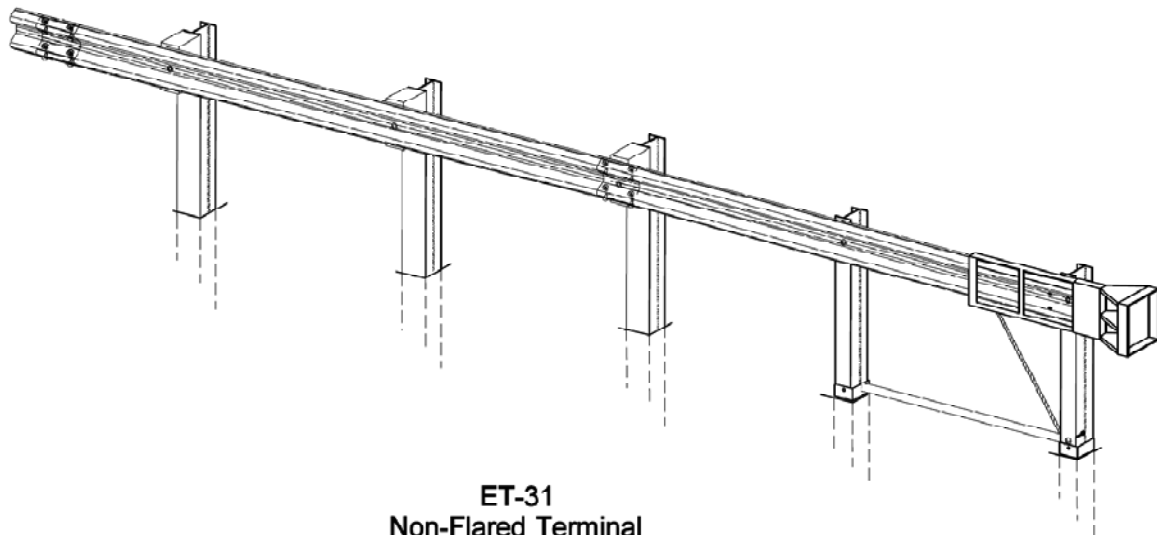

**ET-31
Non-Flared Terminal**

Beam Guardrail Terminals
Exhibit 1610-12a

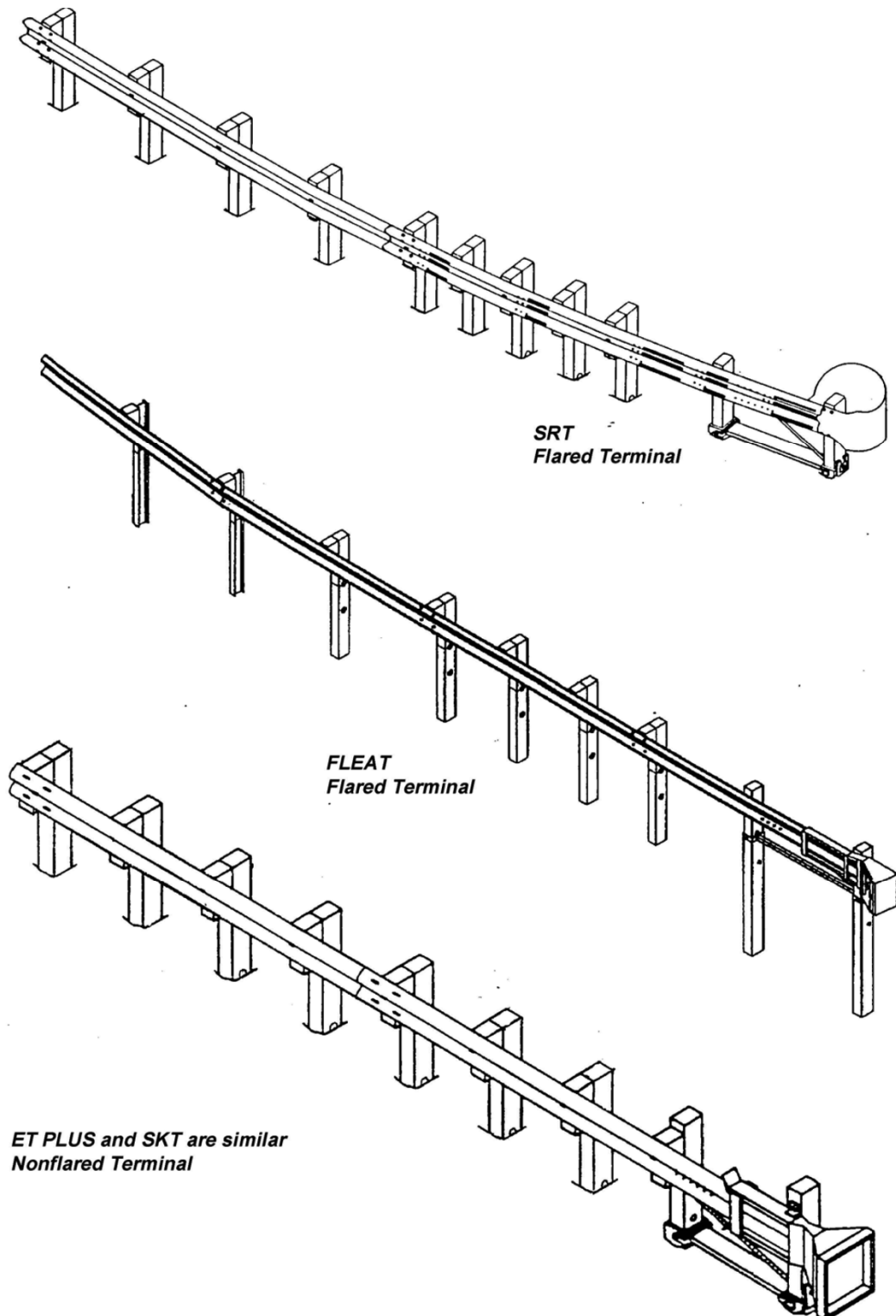

Beam Guardrail Terminals
Exhibit 1610-12b

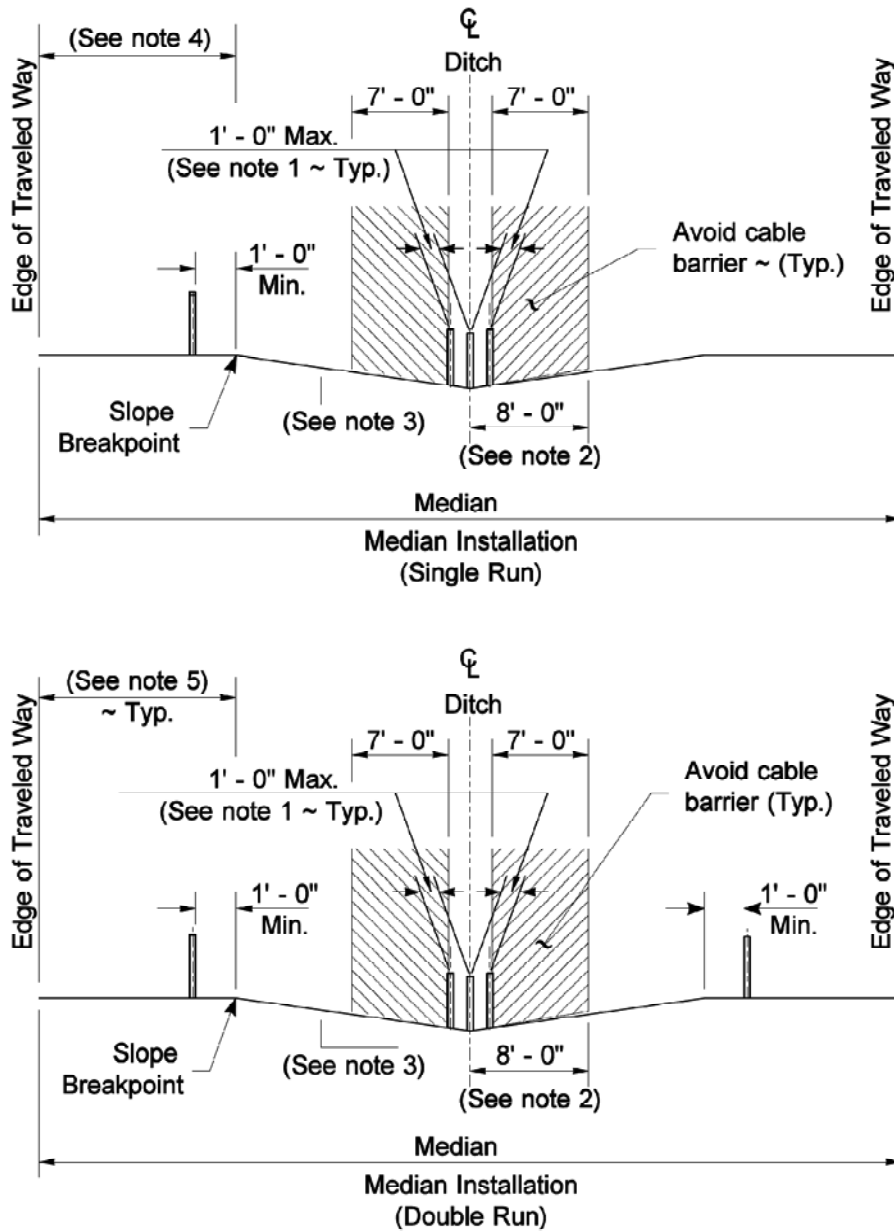

Notes:

- [1] Cable barrier may be installed in the center of the ditch. The cable barrier may be offset from the ditch centerline a maximum of 1 foot in either direction.
- [2] Avoid installing cable barrier within a 1-foot to 8-foot offset from the ditch centerline.
- [3] Applies to slopes between 10H:1V and 6H:1V.
- [4] For single-runs of cable median barrier, with at least 13 feet from edge of the nearest traveled lane to the slope breakpoint, place the cable median barrier at least 1 foot in front of the slope breakpoint. Any approved four-cable high-tension barrier system may be used in this location.
- [5] Double runs of cable barrier are typically not needed. However, if used in situations with at least 11 feet from edge of the nearest traveled lane to the slope breakpoint, place the cable median barrier at least 1 foot in front of the slope breakpoint. Any approved four-cable high-tension barrier system may be used in this location.

Cable Barrier Locations on Median Slopes

Exhibit 1610-13a

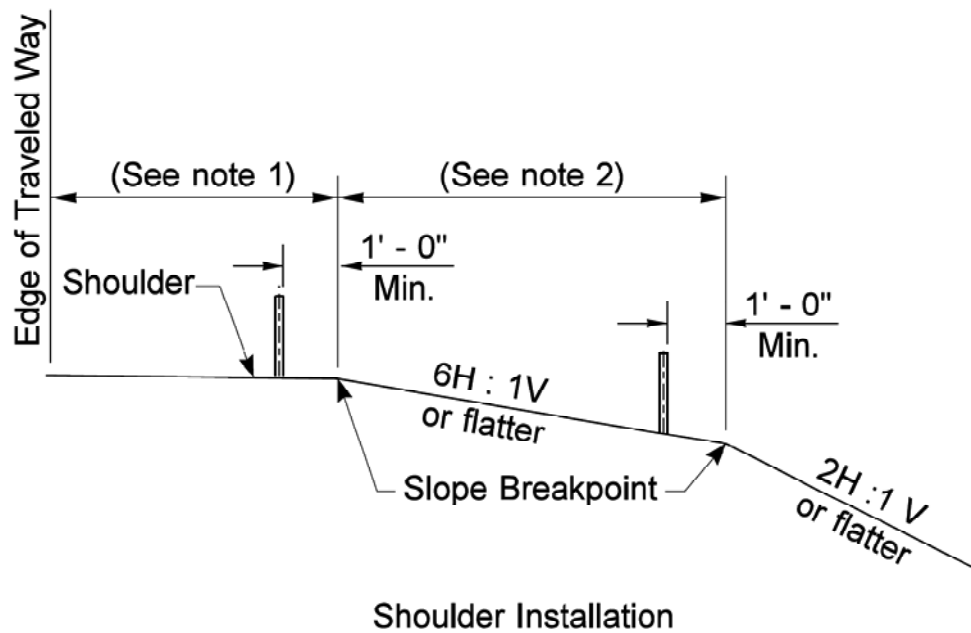

Shoulder Installation

Notes:

- [1] Any approved four-cable high-tension barrier system may be used in this location.
- [2] Use an approved four-cable high-tension cable barrier system within the acceptable locations shown between slope breakpoints.

Cable Barrier Locations on Shoulder Slopes*Exhibit 1610-13b*

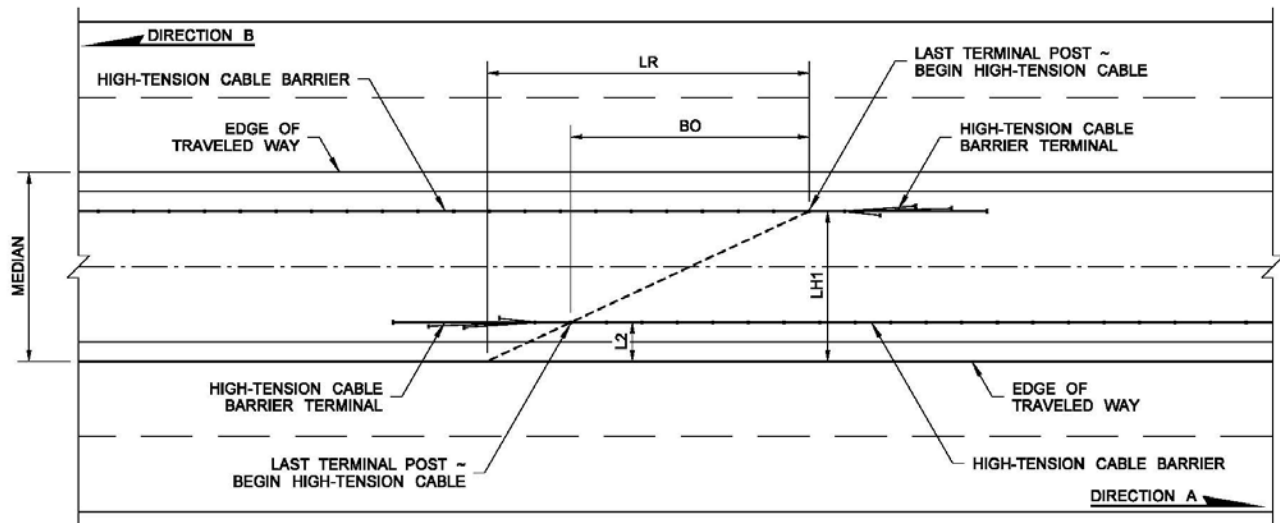

Cable Barrier Median Overlap

$$BO = \frac{LH1 - L2}{(LH1/LR)} \text{ (Direction A shown)}$$

Note:

Calculate barrier overlap (BO) from both directions of travel. Use the greatest value of BO obtained.

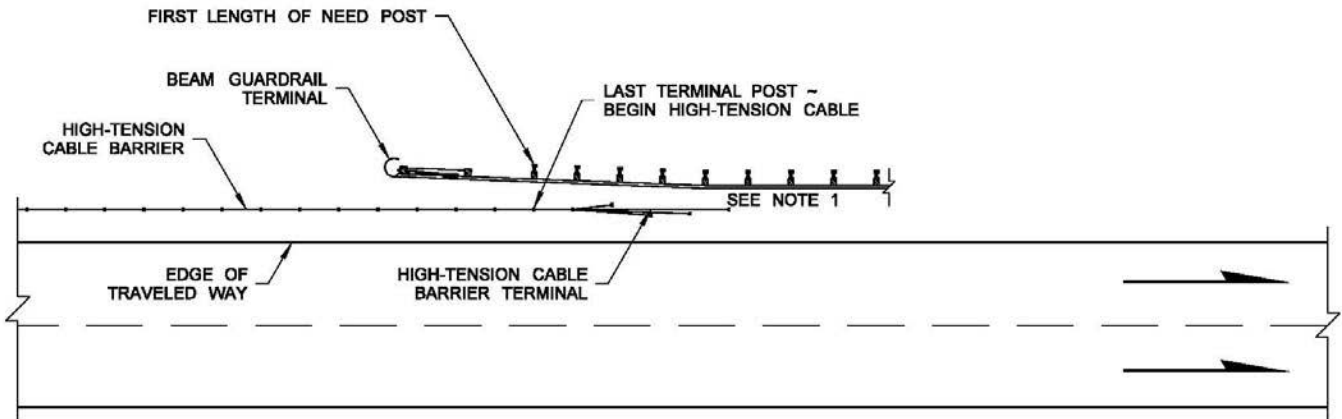

Cable Barrier Overlap With Beam Guardrails

Notes:

- [1] The beam guardrail may need to be extended and flared to maintain adequate barrier overlap and shoulder width.
- [2] Typical applications may be at bridge transitions or where high-tension cable and beam guardrail systems end or begin.
- [3] For supporting length of need equation factors, see Exhibit 1610-10b.

Cable Barrier Placement for Divided Highways

Exhibit 1610-13c

Curb Width	Bridge Width	Concrete Bridge Deck		Wood Bridge Deck or Low-Strength Concrete Deck
		Concrete Bridge Rail (existing)	Steel or Wood Post Bridge Rail (existing)	
<18 inches		Thrie beam mounted to existing bridge rail ^[2] and blocked out to the face of curb. Height = 32 inches	Thrie beam mounted to steel posts ^[2] at the face of curb. Height = 32 inches	<ul style="list-style-type: none"> • Service Level 1 Bridge Rail^[2] • Height = 32 inches • Curb or wheel guard needs to be removed
>18 inches	> 28 ft (curb to curb)	Thrie beam mounted to steel posts ^[2] at the face of curb. ^[1] Height = 32 inches		
>18 inches	< 28 ft (curb to curb)	Thrie beam mounted to existing bridge rail. ^[2] Height = 35 inches	Thrie beam mounted to steel posts ^[2] in line with existing rail. Height = 35 inches	

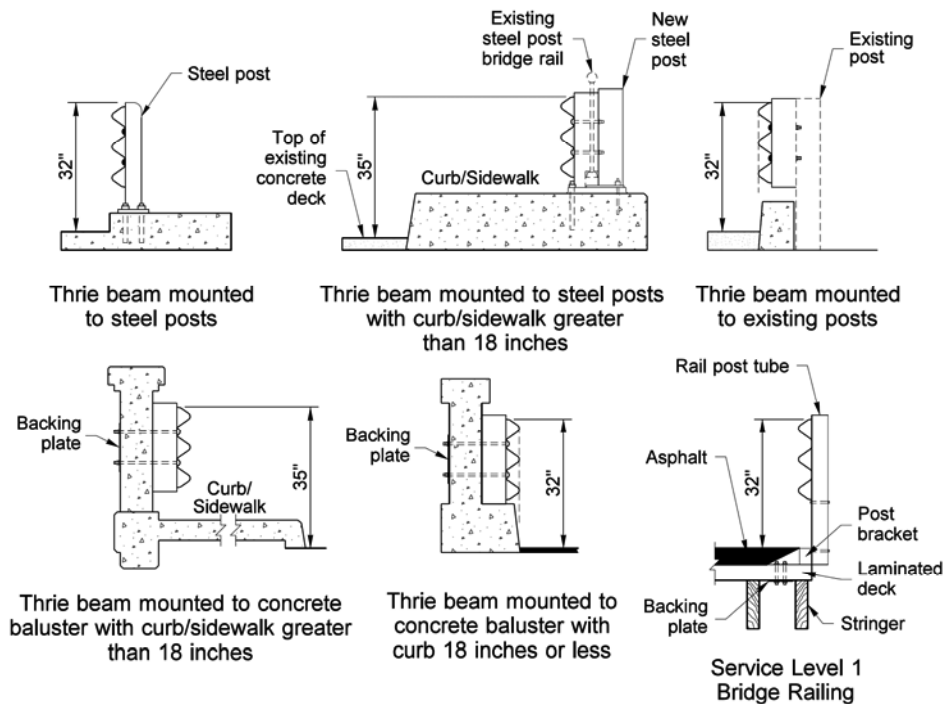

Notes:

- [1] To maximize available curb/sidewalk width for pedestrian use, thrie beam may be mounted to the bridge rail at a height of 35 inches.
- [2] Contact the HQ Bridge and Structures Office for design details on bridge rail retrofit projects.

Thrie Beam Rail Retrofit Criteria

Exhibit 1610-14

