

630.01 General

630.02 References

630.03 Geosynthetic Types and Characteristics

630.04 Geosynthetic Function Definitions and Applications

630.05 Design Approach for Geosynthetics

630.06 Design Responsibility

Exhibit 630-1 Selection Criteria for Geotextile Class

Exhibit 630-2 Maximum Sheet Flow Lengths for Silt Fences

Exhibit 630-3 Maximum Contributing Area for Ditch and Swale Applications

Exhibit 630-4 Design Process for Drainage and Erosion Control: Geotextiles and Nonstandard Applications

Exhibit 630-5 Design Process for Separation, Soil Stabilization, and Silt Fence

Exhibit 630-6 Examples of Various Geosynthetics

Exhibit 630-7 Geotextile Application Examples

Exhibit 630-8 Definition of Slope Length

Exhibit 630-9 Definition of Ditch or Swale Storage Length and Width

Exhibit 630-10 Silt Fences for Large Contributing Area

Exhibit 630-11 Silt Fence End Treatment

Exhibit 630-12 Gravel Check Dams for Silt Fences

## 630.01 General

Geosynthetics include a variety of manufactured products that are used by the Washington State Department of Transportation (WSDOT) in drainage, earthwork, erosion control, and soil reinforcement applications.

The following geosynthetic applications are addressed in the *Standard Specifications for Road, Bridge, and Municipal Construction* (*Standard Specifications*):

- Low survivability underground drainage
- Moderate survivability underground drainage
- Separation
- Soil stabilization
- Moderate survivability permanent erosion control
- High survivability permanent erosion control
- Ditch lining
- Temporary silt fence

The *Standard Specifications* addresses geosynthetic properties as well as installation requirements and are not site-specific. The geosynthetic properties provided are based on the range of soil conditions likely to be encountered in Washington for the applications defined. Other applications, such as prefabricated edge drains, pond liners, and geotextile retaining walls, are currently handled by special provision.

Design responsibilities are discussed in Section 630.05 and illustrated in Exhibit 630-4 and Exhibit 630-5.

This chapter does not address applications where geosynthetics are used to help establish vegetation through temporary prevention of erosion (vegetation mats).

## 630.02 References

### 630.02(1) Design Guidance

*Highway Runoff Manual*, M 31-15, WSDOT

*Hydraulics Manual*, M 23-03, WSDOT

*Plans Preparation Manual*, M 22-31, WSDOT

*Standard Specifications for Road, Bridge, and Municipal Construction* (*Standard Specifications*), M 41-10, WSDOT

WSDOT *Pavement Policy*, available at the Pavements website:

<https://wsdot.wa.gov/engineering-standards/construction-materials/pavement-design-management>

### 630.03 Geosynthetic Types and Characteristics

Geosynthetics include woven and nonwoven geotextiles, geogrids, geonets, geomembranes, and geocomposites. (Examples of the various types of geosynthetics are provided in [Exhibit 630-5](#).) Terms used in the past for these construction materials include fabrics, filter fabric, or filter cloth, which are for the most part synonymous with the newer term geotextile.

#### 630.03(1) Definitions

Definitions of the geosynthetic types are as follows:

##### 630.03(1)(a) Woven Geotextiles

Slit polymer tapes, monofilament fibers, fibrillated yarns, or multifilament yarns simply woven into a mat. Woven geotextiles generally have relatively high strength and stiffness and, except for the monofilament wovens, relatively poor drainage characteristics.

##### 630.03(1)(b) Nonwoven Geotextiles

A sheet of continuous or staple fibers entangled randomly into a felt for needle-punched nonwovens and pressed and melted together at the fiber contact points for heat-bonded nonwovens. Nonwoven geotextiles tend to have low-to-medium strength and stiffness with high elongation at failure and relatively good drainage characteristics. The high elongation characteristic gives them superior ability to deform around stones and sticks.

##### 630.03(1)(c) Geogrids

A polymer grid mat constructed either of coated yarns or a punched and stretched polymer sheet. Geogrids usually have high strength and stiffness and are used primarily for soil reinforcement.

##### 630.03(1)(d) Geonets

Similar to geogrids, but typically lighter weight and weaker, with smaller mesh openings. Geonets are used in light reinforcement applications or are combined with drainage geotextiles to form a drainage structure.

##### 630.03(1)(e) Geomembranes

Impervious polymer sheets that are typically used to line ponds or landfills. In some cases, geomembranes are placed over moisture-sensitive swelling clays to control moisture.

##### 630.03(1)(f) Geocomposites

Prefabricated edge drains, wall drains, and sheet drains that typically consist of a cusped or dimpled polyethylene drainage core wrapped in a geotextile. The geotextile wrap keeps the core clean so that water can freely flow through the drainage core, which acts as a conduit. Prefabricated edge drains are used in place of shallow geotextile-wrapped trench drains at the edges of the roadway to provide subgrade and base drainage. Wall drains and sheet drains are typically placed between the back of the wall and the soil to drain the soil retained by the wall.

### 630.04 Geosynthetic Function Definitions and Applications

The function of the geosynthetic varies with the application. (See [Exhibit 630-7](#) for examples of the various applications.) The geosynthetic must be designed with its application function(s) in mind. Typical geosynthetic functions include filtration, drainage, separation, reinforcement, and erosion control.

### **630.04(1) Definitions**

Definitions of these functions and examples of their dominant applications are as follows:

#### **630.04(1)(a) Geosynthetic Filtration**

The passage of water through the geosynthetic relatively unimpeded (permeability or permittivity) without allowing passage of soil through the geosynthetic (retention). This is the primary function of geotextiles in underground drainage applications.

#### **630.04(1)(b) Drainage**

The carrying of water in the plane of the geosynthetic as a conduit (transmissivity) is a primary function of geocomposite drains. In some cases, the function includes thick, nonwoven needle-punched geotextiles placed in underground drainage applications where water must be transported away from a given location by the geosynthetic itself.

#### **630.04(1)(c) Separation**

The prevention of the mixing of two dissimilar materials. This is a primary function of geotextiles placed between a fine-grained subgrade and a granular base course beneath a roadway.

#### **630.04(1)(d) Reinforcement**

The strengthening of a soil mass by the inclusion of elements (geosynthetics) that have tensile strength. This is the primary function of high-strength geotextiles and geogrids in geosynthetic reinforced wall or slope applications, or in roadways placed over very soft subgrade soils that are inadequate to support the weight of the construction equipment or even the embankment itself.

#### **630.04(1)(e) Geosynthetic Erosion Control**

The minimizing of surficial soil particle movement due to the flow of water over the surface of bare soil or due to the disturbance of soil caused by construction activities under or near bodies of water. This is the primary function of geotextiles used as silt fences or placed beneath riprap or other stones on soil slopes. Silt fences keep eroded soil particles on the construction site, whereas geotextiles placed beneath riprap or other stones on soil slopes prevent erosion from taking place at all. In general, the permanent erosion control methods described in this chapter are only used where more natural means (like the use of biodegradable vegetation mats to establish vegetation to prevent erosion) are not feasible.

These functions control some of the geosynthetic properties, such as apparent opening size (AOS) and permittivity, and in some cases load-strain characteristics.

The application will also affect the geosynthetic installation conditions. These installation conditions influence the remaining geosynthetic properties needed, based on the survivability level required.

#### **630.04(1)(f) Geosynthetic Survivability**

The ability of the geosynthetic to resist installation conditions without significant damage, such that the geosynthetic can function as intended. Survivability affects the strength properties of the geosynthetic required.

### 630.05 Design Approach for Geosynthetics

The following questions must be answered to complete a geosynthetic design:

- Is a geosynthetic really needed?
- What geosynthetic properties will ensure the geosynthetic functions as intended?
- Where should the geosynthetic be located?
- Will maintenance of the geosynthetic, or the structure of which it is a part, be needed? If so, how will it be maintained?

The site conditions and purpose for the geotextile are reviewed to determine whether or not a geotextile is needed.

- For most drainage, separation, soil stabilization, permanent erosion control, and silt fence applications, if a geotextile is needed, the geotextile properties in the *Standard Specifications* can be used.
- In some situations where soil conditions are especially troublesome or in critical or high-risk applications, a project-specific design may be needed.
- The location of the geosynthetic will depend on how it is intended to function. (See *Exhibit 630-7* for examples.)
- Consider the flow path of any groundwater or surface water when locating and selecting the geotextile to be used. For example, in permanent erosion control applications, water may flow to the geotextile from the existing ground as well as from the surface through wave action, stream flow, or overland sheet flow. For saturated fine sandy or silty subgrades, water must be able to flow from the subgrade through the geotextile soil stabilization layer during the pumping action caused by traffic loads.

Background information and the answers to each of these questions, or at least guidance to obtaining the answers to these questions, are provided for each of the following *Standard Specifications* applications:

#### **630.05(1) Underground Drainage: Low and Moderate Survivability**

Geotextiles used for underground drainage must provide filtration to allow water to reach the drain aggregate without allowing the aggregate to be contaminated by finer soil particles.

Geotextile filtration properties are a function of the soil type. For underground drainage applications, if the subgrade soil is relatively clean gravel or coarse sand, a geotextile is probably not required. At issue is whether or not there are enough fines in the surrounding soil to eventually clog the drain rock or drain pipe if unrestricted flow toward the drain is allowed.

To approximately match the geotextile filtration properties to various soil types, specifications for three classes of Construction Geotextile for Underground Drainage are available in the *Standard Specifications*.

For underground drainage applications, use the gradation of the soil, specifically the percent by weight passing the #200 sieve, to select the drainage geotextile class required. Base your selection of the appropriate class of geotextile on *Exhibit 630-1*.

#### **Exhibit 630-1 Selection Criteria for Geotextile Class**

Percent Passing the #200 Sieve	Geotextile Class
Less than 15%	A
15% to 50%	B
Greater than 50%	C

Obtain soil samples for geotextile underdrain design every 300 feet along the roadway alignment, using hand holes, and at major soil type transitions. This may be spread to every 1000 feet if the soil conditions appear to be uniform. Use existing soil data where feasible instead of taking new soil samples.

If soil conditions vary widely along the alignment where underground drainage geotextile is anticipated, different classes of drainage geotextile may be required for specific sections of a continuous system.

Strength properties for the underground drainage geotextile depend on the survivability level required to resist installation stresses.

Low survivability designates that the installation stresses placed on the geotextile will be relatively low, requiring only moderate geotextile strength to resist potentially damaging installation conditions. Examples of low survivability level underground drainage applications include:

- Trench drains.
- Drains placed behind walls or other structures to drain the backfill.
- A geotextile filter sheet placed behind a gabion wall to prevent fines from being washed through the gabion wall face. Trench depths, or the height of the geotextile filter sheet behind gabion walls, must be less than or equal to 6 feet for the low survivability level.

In moderate survivability applications, significant installation stresses may occur, requiring higher geotextile strength. Examples of the moderate survivability application include:

- Trench drains with a depth of greater than 6 feet.
- A geotextile filter sheet behind a gabion wall with a height greater than 6 feet.
- Any area drain.

An area drain is defined as a geotextile placed over or under a horizontal-to-moderately sloping (1.5H:1V or flatter slope) layer of drainage aggregate. Examples of area drains include:

- Drainage layers over cut-and-cover tunnels.
- Rock buttress drainage.
- Permeable base beneath highway pavement (see the *WSDOT Pavement Policy* for additional information on permeable bases).
- A parking lot drainage layer.

Note that pipe wrapping (the geotextile is wrapped around the surface of the pipe) is not included as an underground drainage application.

Locate the geotextile such that it will function as intended. For example, if the objective is to keep the drainage aggregate surrounding a drain pipe clean, locate the geotextile so that it completely separates the drainage aggregate from more silty surrounding soils, which may include native soils as well as relatively silty roadway base or fill materials.

Consider the flow path of any groundwater or surface water when locating the geotextile.

The flow path from the geotextile, as part of the groundwater drainage, is typically directed to a surface water conveyance system. Design of surface water conveyance is guided by the *Hydraulics Manual*. The surface water conveyance must be low enough to prevent backflow and charging of the groundwater drainage—typically, by matching inverts of groundwater drainage to crowns of surface water conveyance pipes. A 1-foot allowance is usually applied when connecting to open water or ditches.

### **630.05(2) Separation**

Geotextile used for separation must prevent penetration of relatively fine grained subgrade soil into the ballast or other roadway or parking lot surfacing material to prevent contamination of the surfacing material (the separation function). This application may also apply to situations other than beneath roadway or parking lot surfacing where it is not necessary for water to drain through the geotextile unimpeded (filtration), but where separation of two dissimilar materials is required.

Separation geotextile should only be used in roadway applications where the subgrade is can be prepared and compacted as required in the *Standard Specifications*, but without removal and replacement of the subgrade soil with granular material. Such removal and replacement defeats the purpose of the geotextile separator.

Separation geotextile placed beneath roadway surfacing is feasible if the subgrade resilient modulus is greater than 5,800 psi and if a saturated fine sandy, silty, or clayey subgrade is not likely to be present. Note that the feasibility of separation geotextile may be dependent on the time of year and weather conditions expected when the geotextile is to be installed.

For separation applications, a geotextile is not needed if the subgrade is dense and granular (silty sands and gravels), but is not saturated fine sands. In general, a separation geotextile is not needed if the subgrade resilient modulus is greater than 15,000 psi.

### **630.05(3) Soil Stabilization**

Geotextile used for soil stabilization must function as a separator, a filtration layer, and (to a minor extent) a reinforcement layer. This application is similar to the separation application, except the subgrade is anticipated to be softer and wetter than in the separation application.

Soil stabilization geotextile is used in roadway applications if the subgrade is too soft and wet to be prepared and compacted as required in the *Standard Specifications*. Soil stabilization geotextile is placed directly on the soft subgrade material, even if some overexcavation of the subgrade is performed. Backfill to replace the overexcavated subgrade is not placed below the geotextile soil stabilization layer, as this would defeat the purpose of the geotextile.

Anticipate the need for soil stabilization geotextile if the subgrade resilient modulus is less than or equal to 5,800 psi, or if a saturated fine sandy, silty, or clayey subgrade is likely to be present.

Consider the flow path of any groundwater or surface water when locating the soil stabilization geotextile and when selecting the geotextile to be used. For saturated fine sandy or silty subgrades, water must be able to flow from the subgrade through the geotextile soil stabilization layer during the pumping action caused by traffic loads.

Even if the subgrade is not anticipated to be saturated based on available data, if the subgrade is silty or clayey and it is anticipated that the geotextile will be installed during prolonged wet weather, a soil stabilization geotextile may still be needed.

Soil stabilization geotextile should not be used for roadway fills greater than 5 feet high or when extremely soft and wet silt, clay, or peat is anticipated at the subgrade level (for example, the deposits encountered in wetlands). In such cases, the reinforcement function becomes more dominant, requiring a site-specific design.

### **630.05(4) Permanent Erosion Control: Moderate and High Survivability**

The primary function of geotextile used for permanent erosion control is to protect the soil beneath it from erosion due to water flowing over the protected soil.

The need for a permanent erosion control geotextile depends on the type and magnitude of water flow over the soil being considered for protection, the soil type in terms of its erodability, and the type and amount of vegetative cover present (see the [Highway Runoff Manual](#)).

The source of flowing water could be streams, constructed channels, wave action, or runoff. Water may also flow from the soil behind the geotextile depending on the groundwater level.

If groundwater cannot escape through the geotextile, an erosion control system failure termed ballooning (resulting from water pressure buildup behind the geotextile) or soil piping could occur. Therefore, the geotextile must have good filtration characteristics.

Three classes of permanent erosion control geotextile are available to approximately match geotextile filtration characteristics to the soil. In order to select the drainage geotextile class, determine the gradation of the soil, specifically the percent by weight passing the #200 sieve. Base selection of the appropriate class of geotextile on [Exhibit 630-1](#).

A minimal amount of soil sampling and testing is needed to determine the geotextile class required. Permanent erosion control geotextile generally does not extend along the roadway alignment for significant distances as does underground drainage geotextile. One soil sample per permanent erosion control location is sufficient. If multiple erosion control locations are anticipated along a roadway alignment, soil sampling requirements for underground drainage can be applied.

If soil conditions vary widely along the alignment where permanent erosion control geotextile is anticipated, different classes of erosion control geotextile may be required for specific sections of a continuous system.

Examples of the permanent erosion control application are the placement of geotextile beneath riprap or gabions along drainage channels, shorelines, and waterways; around bridge piers; and under slope protection for highway cut or fill slopes.

If a moderate survivability geotextile is to be used, the geotextile must be protected by a 12-inch aggregate cushion and be placed on slopes of 2H:1V or flatter to keep installation stresses to a relatively low level. Large stones can cause significant damage to a moderate survivability geotextile if the geotextile is not protected in this manner. If these conditions are not met, then a high survivability erosion control geotextile must be used.

### **630.05(5) Ditch Lining**

The primary function of the geotextile in a ditch lining application is to protect the soil beneath it from erosion. This ditch lining application is limited to constructed ditches less than 16 feet wide at the top with side slopes of 2H:1V or flatter.

If the ditch does not meet these requirements, then permanent erosion control, with moderate or high survivability geotextile, must be used. It is assumed that only quarry spall-sized stones or smaller will be placed on the geotextile, so only a moderate survivability geotextile will be required.

Filtration is not a significant function in this application. Since the ditch is relatively shallow, it is expected that the main water source will be the water carried by the ditch, and little water will pass through the geotextile.

Another application with a similar geotextile function is the placement of geotextile below culvert outlets to prevent erosion at the outlet.



### 630.05(6) Temporary Silt Fence

The primary function of geotextile used in a temporary silt fence is to prevent eroded material from being transported away from the construction site by runoff water. The silt fence acts primarily as a temporary dam and secondarily as a filter. In some cases, depending on the topography, the silt fence may also function as a barrier to direct flow to low areas at the bottom of swales where the water can be collected and temporarily ponded. It is desirable to avoid the barrier function as much as possible, as silt fences are best suited to intercepting sheet flow rather than the concentrated flows that would occur in swales or intermittent drainage channels. To function as intended, the silt fence should have a low enough permeability to allow the water to be temporarily retained behind the fence, allowing suspended soil particles in the water to settle to the ground. If the retention time is too long, or if the flow rate of water is too high, the silt fence could be overtopped, thus allowing silt-laden water to escape. Therefore, a minimal amount of water must be able to flow through the fence at all times.

Temporary water ponding is considered the primary method of silt removal and the filtration capabilities of the fence are the second line of defense. However, removal of silt-sized particles from the water directly by the geotextile creates severe filtration conditions for the geotextile, forcing the geotextile to either blind or allow the fines to pipe through the geotextile. (*Blinding* is the coating of the geotextile surface with soil particles such that the openings are effectively plugged.) If the geotextile openings (AOS) are designed to be small enough to capture most of the suspended soil particles, the geotextile will likely blind, reducing the permeability enough to allow water to overtop the fence. Therefore, it is best to allow some geotextile openings that are large enough to allow the silt-sized particles to easily pass through. Even if some silt particles pass through the fence, the water flow rate below the fence will be decreased and the volume of silt-laden water passing through the geotextile is likely to be relatively small and the water is partially filtered.

The geotextile apparent opening size (AOS) and permittivity are typically used to specify the filtration performance of geotextiles. The geotextile function in silt fence applications is more complex than this and AOS and permittivity do not relate directly to how well a silt fence will perform. However, nominal values of AOS and permittivity can be specified such that the types of geotextile products known to perform satisfactorily in this application are selected. These values are provided in the [Standard Specifications](#).

The source of load on the geotextile is from silt buildup at the fence and water ponding. The amount of strength required to resist this load depends on whether or not the geotextile is supported with a wire or polymer grid mesh between the fence posts. Obviously, unsupported geotextile must have greater strength than supported geotextile. If the strength of the geotextile or its support system is inadequate, the silt fence could fail. Furthermore, unsupported geotextile must have enough stiffness that it does not deform excessively and allow silt-laden water to go over the top of the fence.

#### 630.05(6)(a) Need for Silt Fence

The need for a silt fence can be anticipated where construction activities disturb and expose soil that could erode. The ground surface is considered disturbed if vegetative cover is at least partially removed over a significant area by construction activities. Consider whether or not silt-laden runoff water from the disturbed area can reach an environmentally sensitive area or a constructed stormwater system. If the exposed soil is a clean sand or gravel or if a significant zone of heavy vegetative cover separates the exposed soil from the environmentally sensitive area, a silt fence may not even be needed. Contact the Headquarters (HQ) Hydraulics Section for help in determining whether or not a silt fence is needed in such situations.



### 630.05(6)(b) Feasibility of Silt Fence

The feasibility of a geotextile silt fence depends on the magnitude of water flow to the fence, the steepness of the slope behind the fence, and whether or not flow is concentrated at the fence. If the silt fence is not feasible, alternative erosion control methods may be needed (see the [Highway Runoff Manual](#)).

Consider all feasible erosion control options in terms of potential effectiveness and economy before making the final decision to use a silt fence. Select the best option for the site conditions, including site geometry and contours, soil type, and rainfall potential. Consider silt fences for temporary erosion control in disturbed areas in the following circumstances:

- Fully covering disturbed areas temporarily with polyethylene sheeting or other temporary covering is not feasible or practical.
- Permanent ground cover for disturbed areas is not yet established.
- Runoff water reaches the silt fence primarily as sheet flow rather than as concentrated flows, with the exception of some ditch and swale applications.
- Slopes above the silt fence are not steeper than 1.5H:1V.
- The sheet flow length (length of slope contributing runoff water to the silt fence) is not too long.

### 630.05(6)(c) Sheet Flow Length

Maximum sheet flow lengths allowed for silt fences are provided in [Exhibit 630-2](#), which is based on the typical 2-year, 24-hour design storm for Washington, resulting in a 24-hour rainfall of 3 inches.

#### Exhibit 630-2 Maximum Sheet Flow Lengths for Silt Fences

Slope	Sheet Flow Length
1.5H:1V	100 ft
2H:1V	115 ft
4H:1V	150 ft
6H:1V	200 ft

The sheet flow length represents the area contributing runoff water from precipitation. The sheet flow length is defined in [Exhibit 630-8](#). The sheet flow lengths provided in [Exhibit 630-2](#) were determined assuming a bare soil condition, with the soil classified as a silt. These are worst-case assumptions because less runoff would be expected for sand or gravel soils or when some vegetation is present.

The sheet flow length is usually equal to or greater than the disturbed soil slope length. However, undisturbed sloping ground above the disturbed slope area may also contribute runoff to the silt fence area. The length of undisturbed sloping ground above the disturbed slope to be included in the total contributing slope length depends on the amount and type of vegetation present, the slope steepness, and the degree of development above the slope.

If unsure whether the proposed silt fence meets the requirements in [Exhibit 630-2](#), contact the HQ Hydraulics Section for assistance.

**Exhibit 630-3 Maximum Contributing Area for Ditch and Swale Applications**

Average or Ditch Swale Grade	Ditch or Swale Storage Length	Allowable Contributing Area per Foot of Ditch or Swale Storage Width
16%	13 ft	200 ft <sup>2</sup>
10%	20 ft	250 ft <sup>2</sup>
5%	40 ft	300 ft <sup>2</sup>
4%	50 ft	400 ft <sup>2</sup>
3%	65 ft	500 ft <sup>2</sup>
2%	100 ft	600 ft <sup>2</sup>
1%	200 ft	1000 ft <sup>2</sup>

**630.05(6)(d) Temporary Silt Fence**

Temporary silt fences may also be used in ditch or swale applications. If the area contributing runoff to the fence exceeds the value determined from [Exhibit 630-3](#), hydraulic overload will occur. The ditch or swale storage length and width are defined in [Exhibit 630-9](#). The assumptions used in the development of [Exhibit 630-3](#) are the same as those used for [Exhibit 630-2](#) in terms of the design storm and ground conditions.

As an example, if a site has a 13-foot-wide ditch with an average slope of 2%, the fence can be located such that 7800 ft<sup>2</sup> of area drain to it. If it appears that the area draining to the fence will be larger than the allowable, it may be possible to divide the contributing area into smaller areas and add a silt fence for each smaller area as shown in [Exhibit 630-10](#).

The minimum storage length for the ditch behind each silt fence must be maintained. If this is not possible, it may be necessary to use an alternate erosion control structure, as described in the *Highway Runoff Manual*, or develop a special silt fence design.

[Exhibit 630-3](#) was developed with the assumption that water will be able to pond to a depth of at least 2 feet behind the fence. If this is not the case (the ditch or swale depth is less than 2 feet), the table cannot be used. Furthermore, the ditch depth must be greater than the height of the silt fence at its lowest point within the ditch. Otherwise, there will not be enough storage available behind the fence and water will circumvent the fence by flowing around it.

**630.05(6)(e) Locating a Silt Fence**

Locate silt fences on contour as much as possible. At the ends of the fence, turn it up hill such that it captures the runoff water and prevents water from flowing around the end of the fence. This is illustrated in [Exhibit 630-11](#).

Silt fences are designed to capture up to a 2-foot depth of water behind the fence. Therefore, the ground line at the ends of the fence must be at least 2 feet above the ground line at the lowest part of the fence. This 2-foot requirement applies to ditches as well as to general slope erosion control.

If the fence must cross contours (except for the ends of the fence), use gravel check dams placed perpendicular to the back of the fence to minimize concentrated flow and erosion along the back of the fence (see [Exhibit 630-12](#)).

- The gravel check dams are approximately 1 foot high at the back of the fence and are continued perpendicular to the fence at the same elevation until the top of the dam intercepts the ground surface behind the fence.
- Locate the gravel check dams every 10 feet along the fence.
- In general, the slope of the fence line is not to be steeper than 3H:1V.
- For the gravel check dams, use Crushed Surfacing Base Course, Gravel Backfill for Walls, or Permeable Ballast (see the [Standard Specifications](#)).

If the silt fence application is considered critical (such as when the fence is placed immediately adjacent to environmentally sensitive areas like streams, lakes, or wetlands), place a second silt fence below the first silt fence to capture any silt that passes through the first fence and/or place straw bales behind the silt fence. Locate silt fences at least 7 feet from an environmentally sensitive area. Where this is impossible, and a silt fence must be used, a special design may be necessary.

Temporary silt fences are sometimes used to completely encircle underground drainage inlets or other similar features to prevent silt from entering the drainage system. This is acceptable, but the silt fence functions primarily as a barrier, and not as a ponding or filtering mechanism, unless the drainage inlet is in a depression that is large enough to allow water to pond behind the silt fence.

- If the drainage inlet and silt fence are not in a large enough depression, silt-laden water will simply be directed around the fence and must be captured by another fence or sedimentation pond downslope.
- If the depression is deep, locate the silt fence no more than 2 feet below the top of the depression to prevent overtopping. A site-specific design may be needed if the silt fence is located deeper than 2 feet within the depression.

It may be necessary to relocate silt fences during the course of a construction project as cuts and fills are built or as disturbed areas change. An erosion control/silt fence plan that accounts for the anticipated construction stages (and eventual removal) should be developed. Do not assume that one silt fence location can routinely be used for the entire life of the contract. Periodically check the locations in the field during the construction project, and field-adjust the silt fence locations as necessary to ensure the silt fences function as intended.

### **630.05(7) Standard Specification Geotextile Application Identification in the Contract Plans**

Identify the geotextile in the contract plan detail in a way that ties it to the appropriate application in the [Standard Specifications](#). For example:

- If a geotextile is to be used to line an underground trench drain 3 feet deep and the native soil has less than 15% passing the #200 sieve, identify the geotextile on the plan sheet as “Construction Geotextile for Underground Drainage, Low Survivability, Class A.”
- If the geotextile is to be placed beneath riprap on a slope without a cushion layer between the geotextile and the riprap, and the native soil contains 35% passing the #200 sieve, identify the geotextile on the plan sheet as “Construction Geotextile for Permanent Erosion Control, High Survivability, Class B.”

- If the geotextile is to be placed between the roadway base course and a moist silt subgrade with a resilient modulus of 6,500 psi, and the roadway is planned to be constructed during the dry summer and early fall months, identify the geotextile on the plan sheet as “Construction Geotextile for Separation.”

### **630.05(8) Site-Specific Designs (All Applications)**

A site-specific design is required:

- For all reinforcement applications.
- For applications not covered by the [Standard Specifications](#).

Consider a site-specific design for:

- High-risk applications.
- Exceptionally large geotextile projects: if the geotextile quantity in a single application is over 35,000 yd<sup>2</sup> or over 85,000 yd<sup>2</sup> for the separation application.
- Severe or unusual soil or groundwater conditions.
- Soil in the vicinity of the proposed geotextile location that consists of alternate thin layers of silt or clay with potentially water-bearing sand layers on the order of 1 to 3 inches thick or less.
- Soil known through past experience to be problematic for geosynthetic drains.
- Drains in native soil behind structures except drains contained within granular backfill.
- Drains designed to stabilize unstable slopes.
- Drains designed to mitigate frost heave.

In such cases, obtain assistance from the HQ Materials Laboratory, Geotechnical Office. To initiate the special design, provide a plan and cross section showing:

- The geosynthetic structure to be designed.
- The structure’s relative location to other adjacent structures that it could potentially affect.
- The structure’s intended purpose.
- Any soil data in the vicinity.

Consider a site-specific design for temporary silt fences:

- If silt fence must be used in intermittent streams or where a significant portion of the silt fence functions as a barrier that directs flow to the lower portions of the silt fence.
- If the fence must be located on steep slopes.
- In situations not meeting the requirements in [Exhibit 630-2](#) and [Exhibit 630-3](#).
- If the 2-year, 24-hour design storm for the site is greater than the 3 inches assumed for the development of [Exhibit 630-2](#) and [Exhibit 630-3](#).
- Where concentrated flow is anticipated.
- If closer than 7 feet from an environmentally sensitive area.
- If more than 2 feet of storage depth is needed.

For a site-specific temporary silt fence design, obtain assistance from the HQ Hydraulics Section. To initiate the design, send the following information to the HQ Hydraulics Section and a copy to the HQ Materials Laboratory, Geotechnical Office:

- Plan sheets showing proposed silt fence locations and grading contours.
- Estimate of the area contributing runoff to each silt fence, including percentage and general type of vegetative cover within the contributing area.
- Any available site soil information.

For all site-specific designs of applications not covered by the *Standard Specifications*, complete plans and special provisions are needed. In general, for site-specific designs of *Standard Specifications* applications, only a minor modification of the appropriate geotextile property table will be needed.

### 630.06 Design Responsibility

The design responsibility and process for geotextile design are illustrated in [Exhibit 630-4](#) and [Exhibit 630-5](#). The region Project Development Office, in particular the region Project Manager, is responsible to initiate and develop all geotextile designs for the *Standard Specifications*, except for roadway separation and soil stabilization applications, which are initiated and developed by the region Materials Laboratory.

The region Materials Laboratory assists the region Project Manager with *Standard Specifications* underground drainage and permanent erosion control designs.

The region Environmental Design Office assists with *Standard Specifications*, permanent erosion control, and temporary silt fence designs.

Once the region Project Manager or Materials Laboratory has determined that a geotextile is appropriate, development of a geotextile design for the *Standard Specifications* includes the development of plan details showing the plan location and cross section of the geotextile installation. Standard details for geotextiles as provided in the *Plans Preparation Manual* may be used or modified to adapt to the specific project situation. Note that only minimum dimensions for drains are provided in these standard details.

Site-specific geosynthetic designs and applications not addressed by the *Standard Specifications* are designed by the region with the assistance of the HQ Materials Laboratory, Geotechnical Office, or the HQ Hydraulics Section as described in Section 630.05.

Design assistance by the HQ Geotechnical Office or HQ Hydraulics Section for site-specific design of *Standard Specifications* applications includes determination of geosynthetic properties and other advice as needed to complete the geosynthetic plans and any special provisions required.

The HQ Geotechnical Office is fully responsible to develop and complete the following:

- Geosynthetic design, plan details that can be used to develop the contract plan sheets, and special provisions for geosynthetic reinforced walls, slopes, and embankments.
- Deep trench drains for landslide stabilization.
- Other applications that are an integral part of a Headquarters geotechnical design.

The region Project Manager incorporates the plan details and special provisions into the PS&E.

Exhibit 630-4 Design Process for Drainage and Erosion Control: Geotextiles and Nonstandard Applications

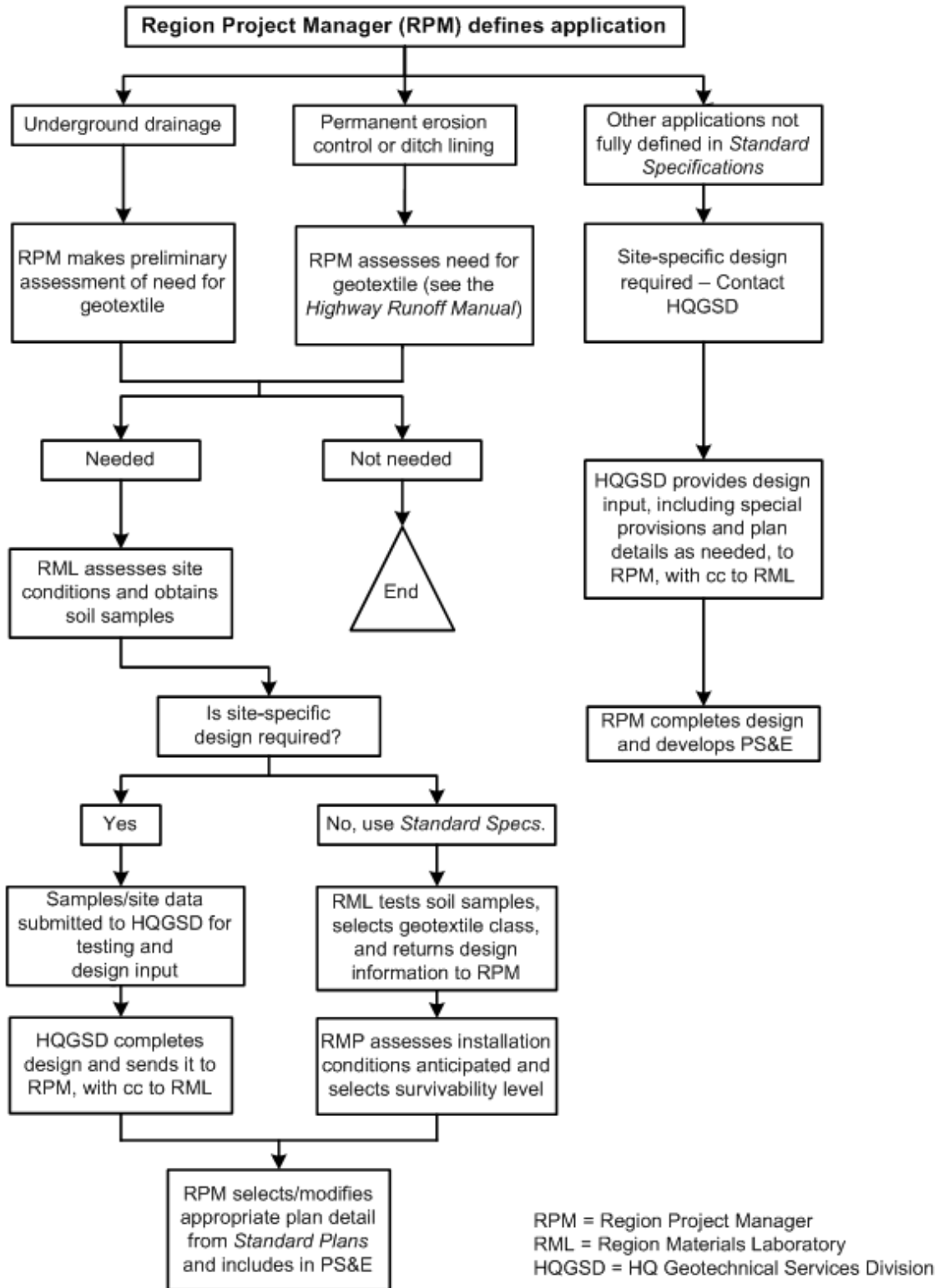

Exhibit 630-5 Design Process for Separation, Soil Stabilization, and Silt Fence

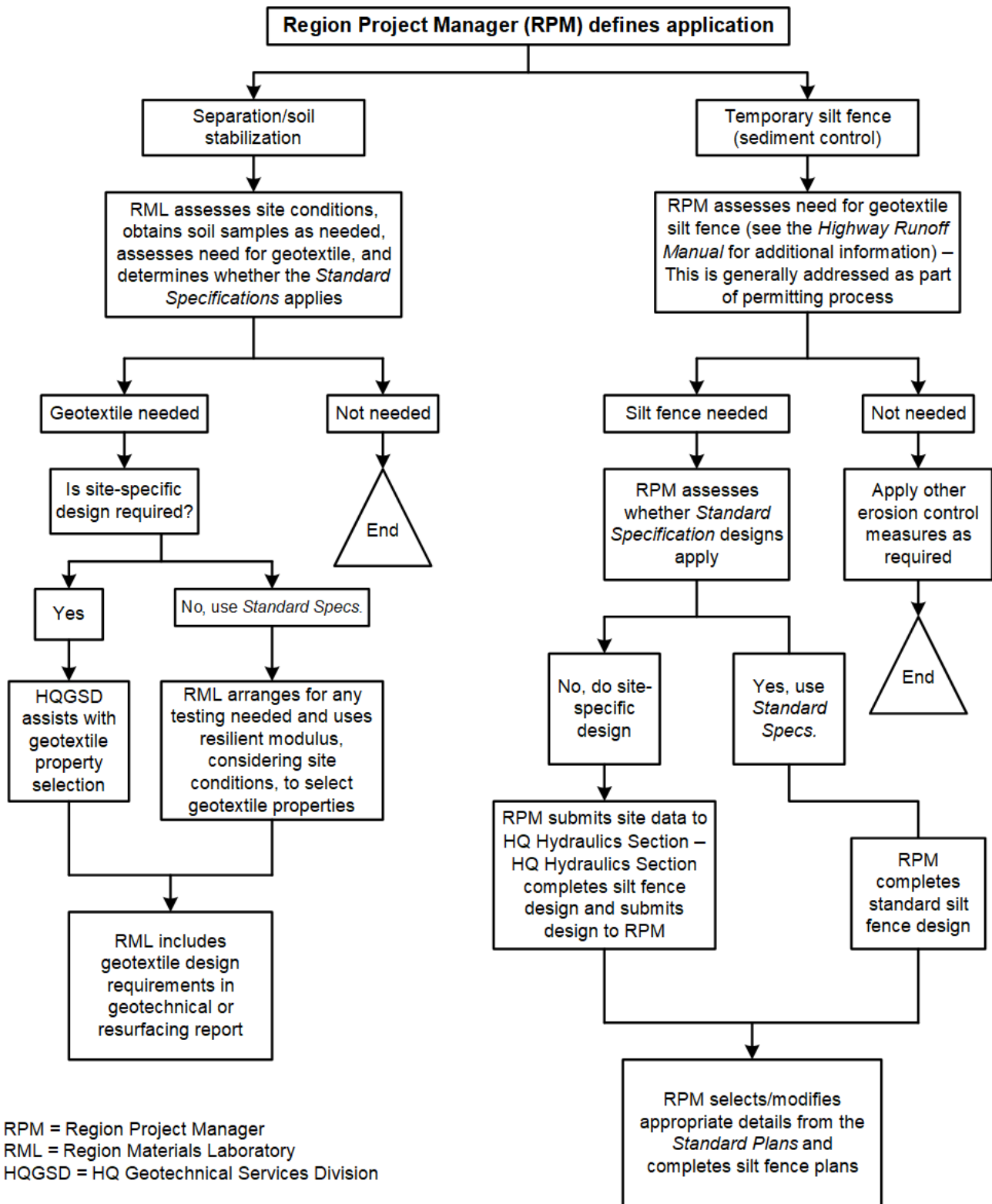
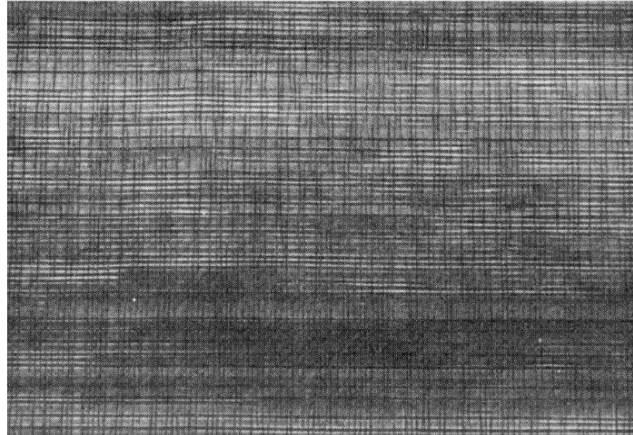
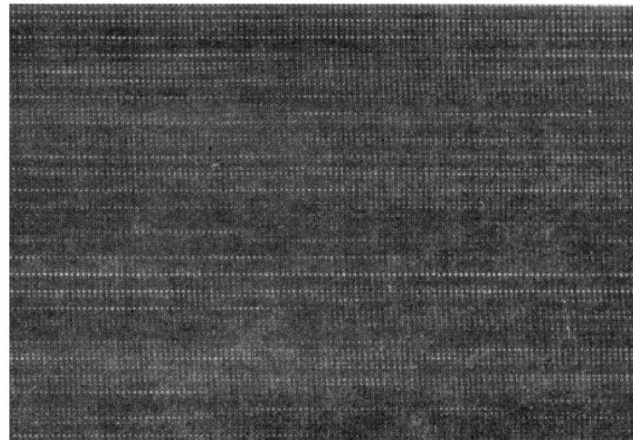



Exhibit 630-6 Examples of Various Geosynthetics



*Slit Film Woven Geotextile*



*Monofilament Woven Geotextile*

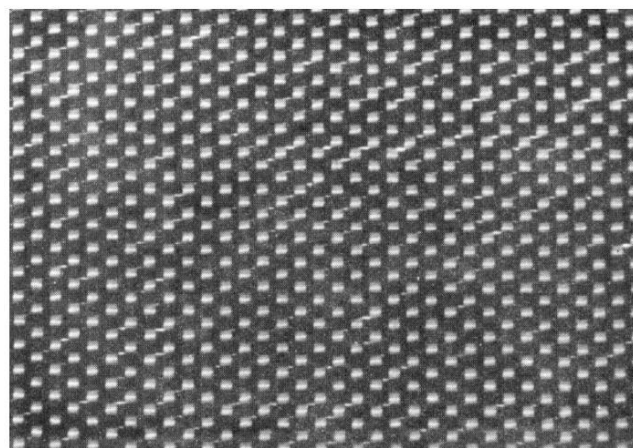

*Multifilament Woven Geotextile*

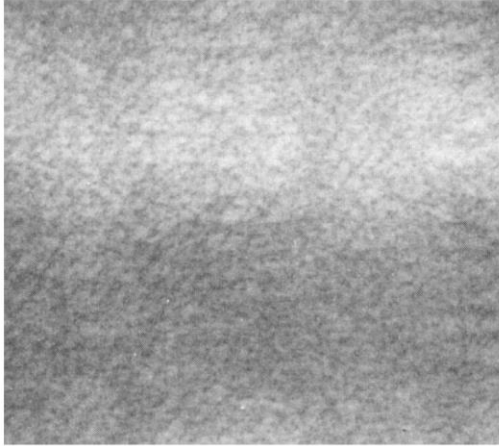

*Needle-Punched Nonwoven Geotextile*

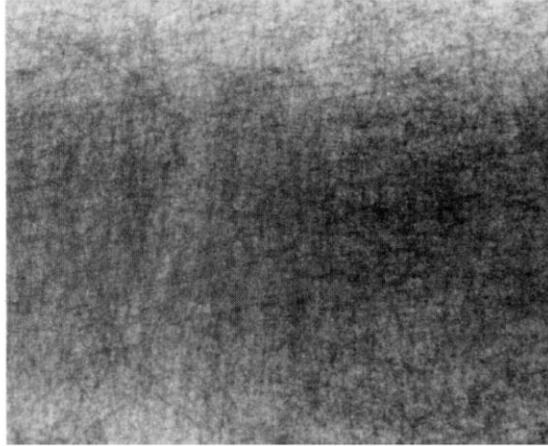

*Heat-Bonded Nonwoven Geotextile*

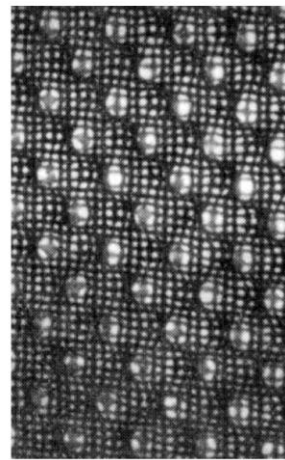
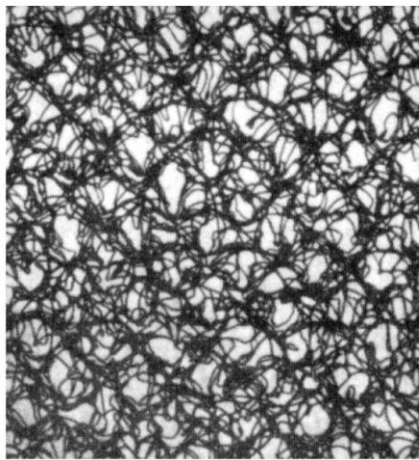
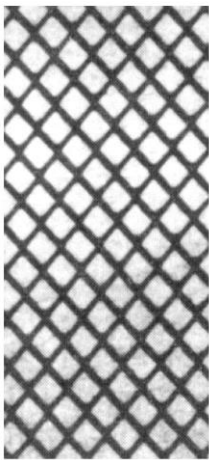

*Geocomposite Drains (Geotextile With Core)*

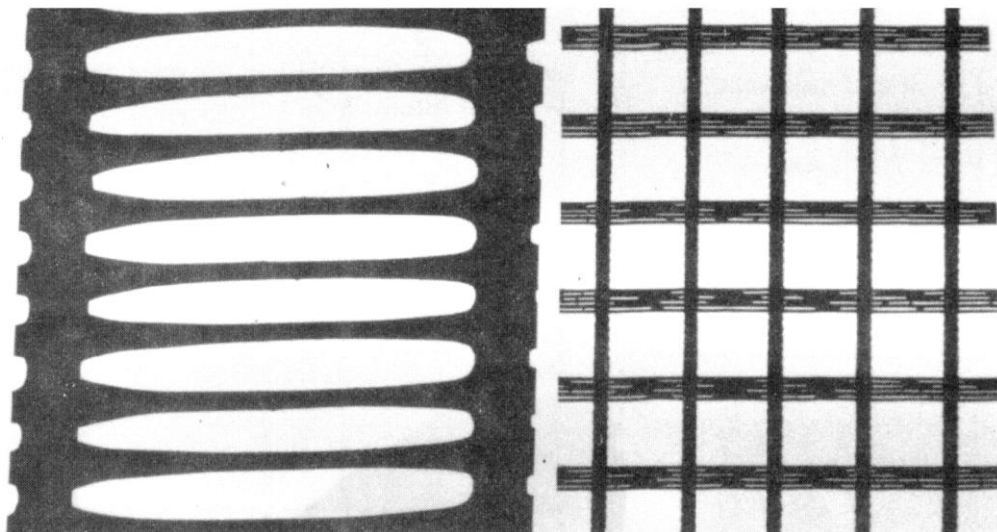

*Extruded and Woven Geogrids*

Exhibit 630-7 Geotextile Application Examples

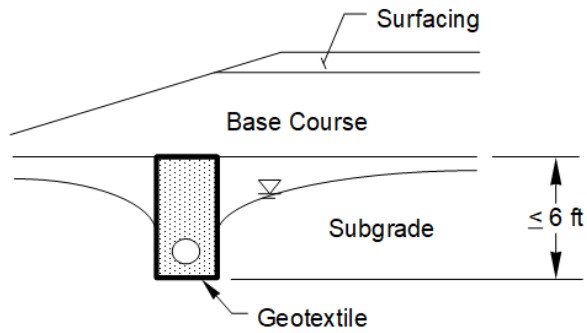

A. Underground Drainage: Low Survivability (Roadway Trench Drain)

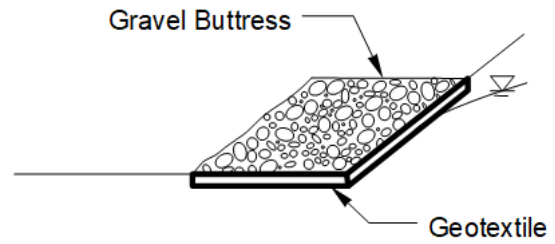

B. Underground Drainage: Moderate Survivability (Area Drain Beneath Buttress)

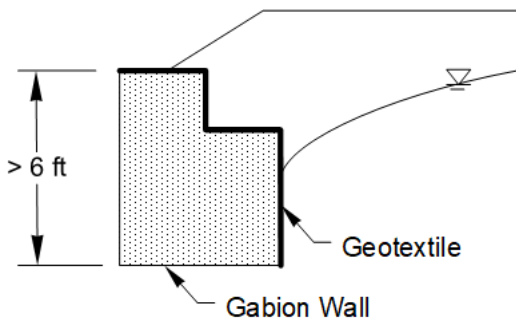

C. Underground Drainage: Moderate Survivability (Geotextile Sheet Drain)

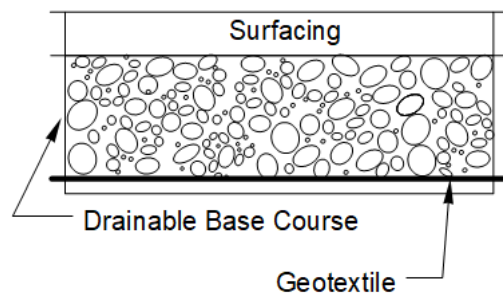

D. Underground Drainage: Moderate Survivability (Area Drain Under Parking Lot or Roadway)

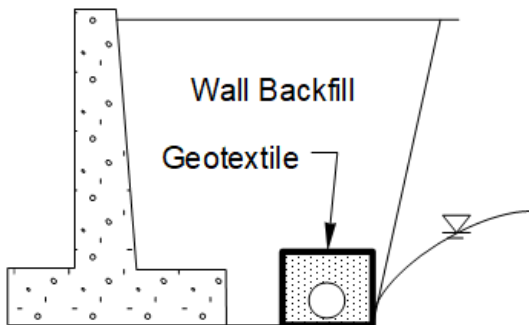

E. Underground Drainage: Low Survivability (Wrapped Drain Behind Foundation)

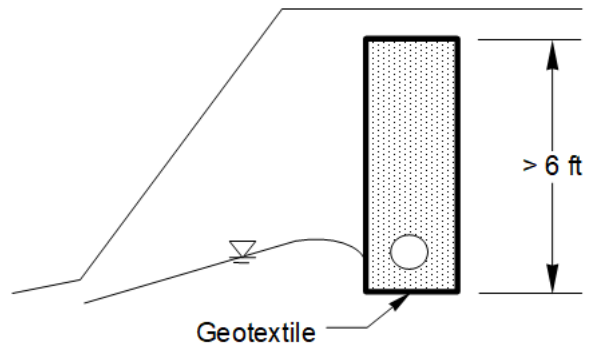

F. Underground Drainage: Moderate Survivability (Deep Trench Drain for Slope Stabilization)

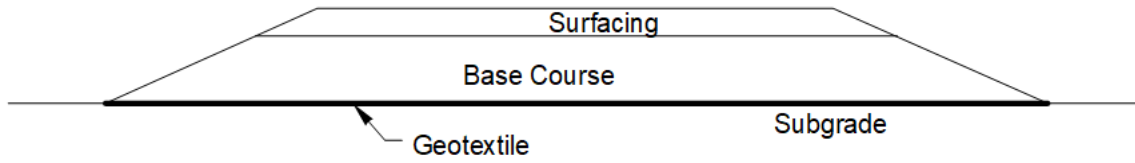

G. Separation or Soil Stabilization for New Roadway (Depends on Subgrade Condition)

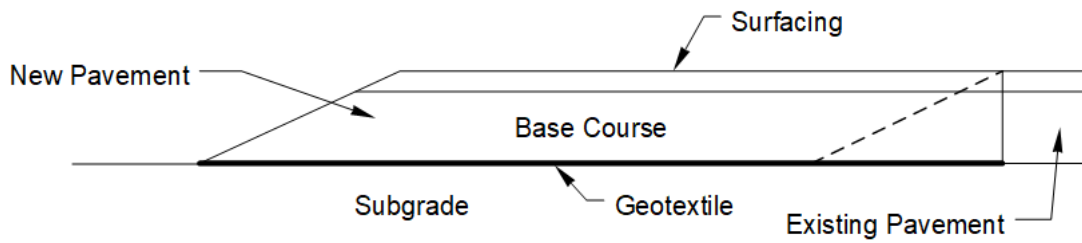

H. Separation or Soil Stabilization for Widened Roadway (Depends on Subgrade Condition)

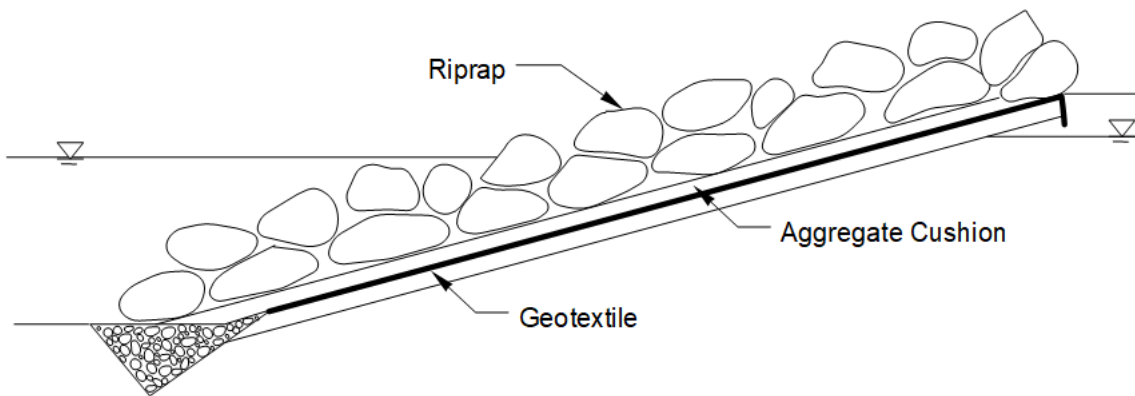

I. Permanent Erosion Control: Moderate Survivability

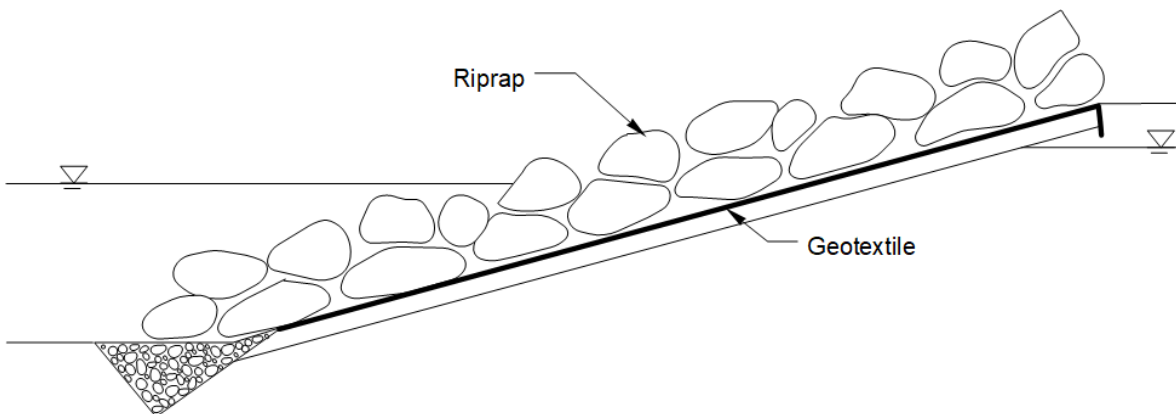

J. Permanent Erosion Control: High Survivability



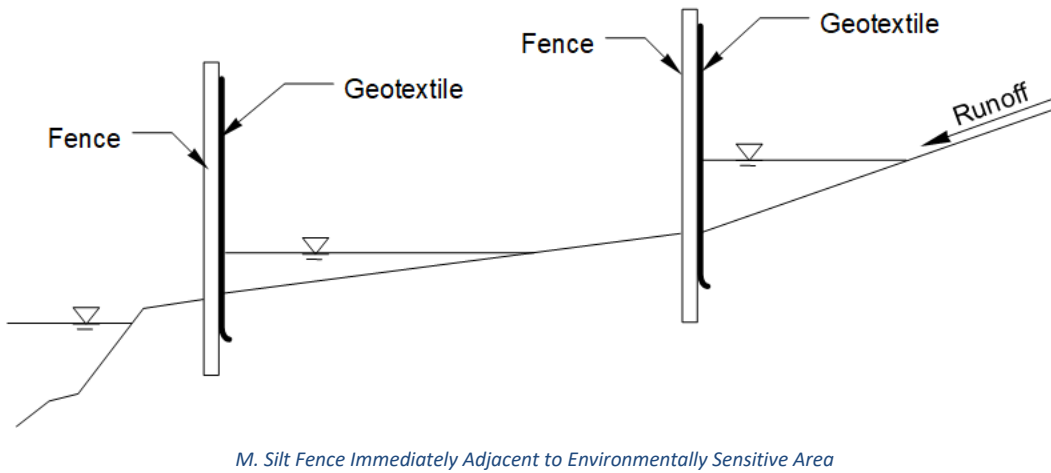
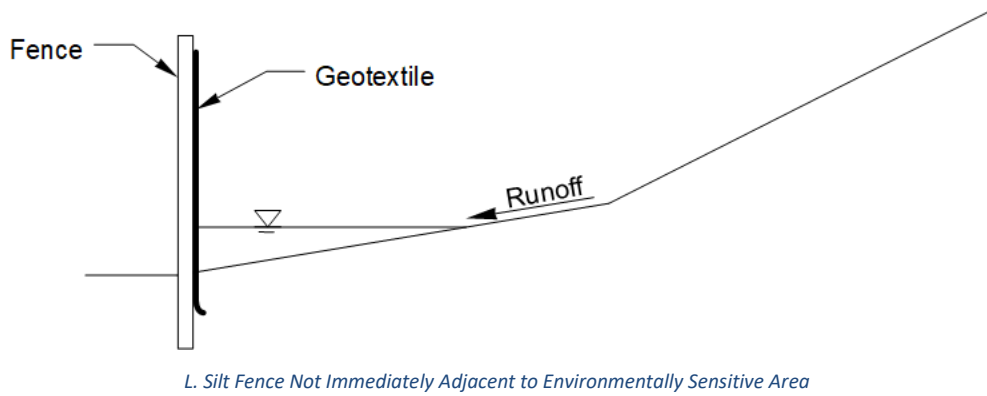
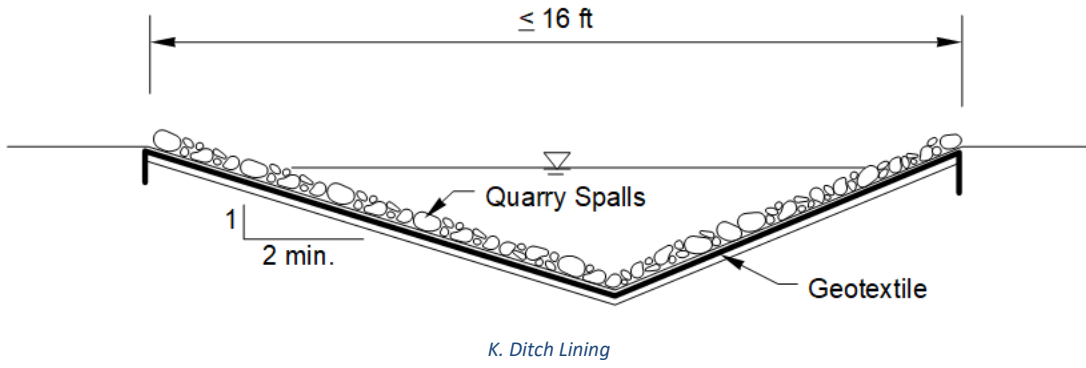

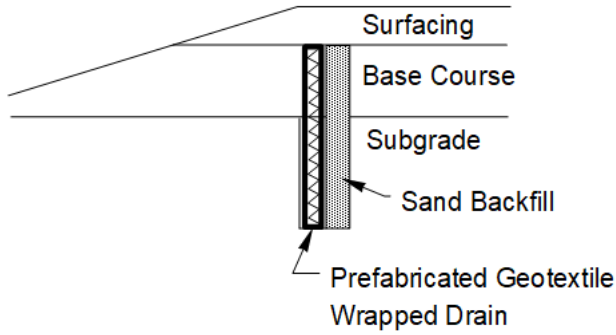

N. Prefabricated Edge Drain for Roadway

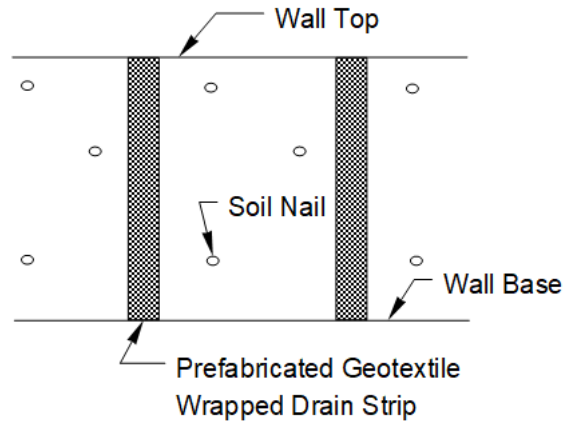

O. Prefabricated Drain Strip Behind Wall Face

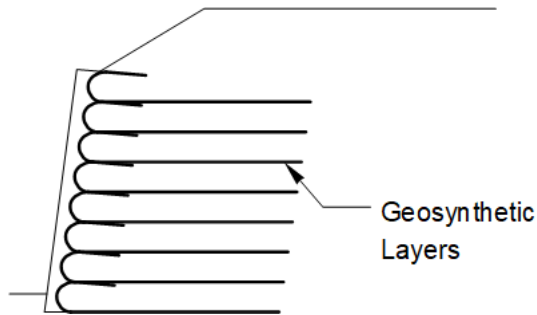

P. Geosynthetic Wall

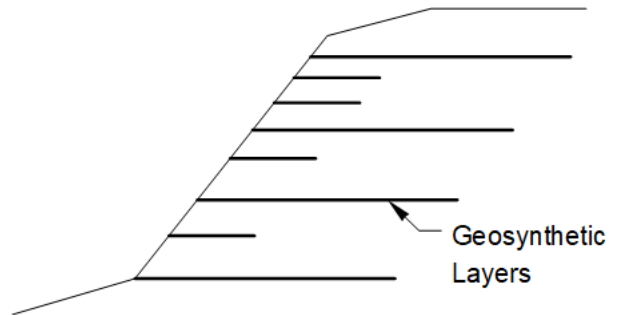

Q. Geosynthetic Reinforced Slope

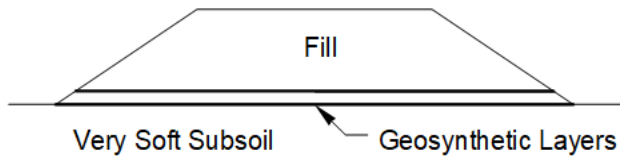

R. Geosynthetic Reinforced Embankment

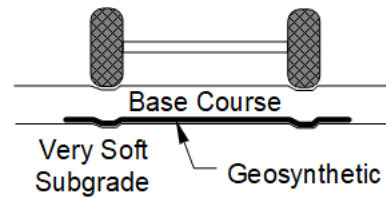

S. Geosynthetic Subgrade Reinforcement for Temporary Roads

Exhibit 630-8 Definition of Slope Length

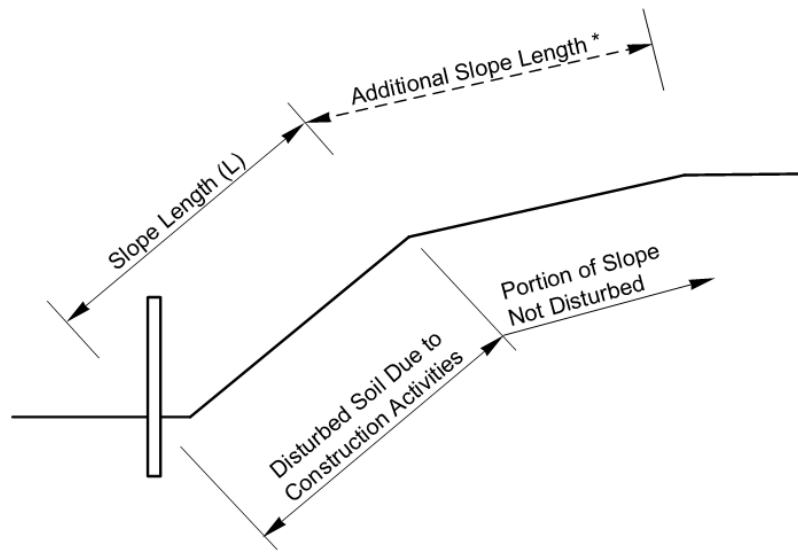

\* May need to be included as part of slope length depending on vegetative cover, slope steepness, and degree of development above slope

Exhibit 630-9 Definition of Ditch or Swale Storage Length and Width

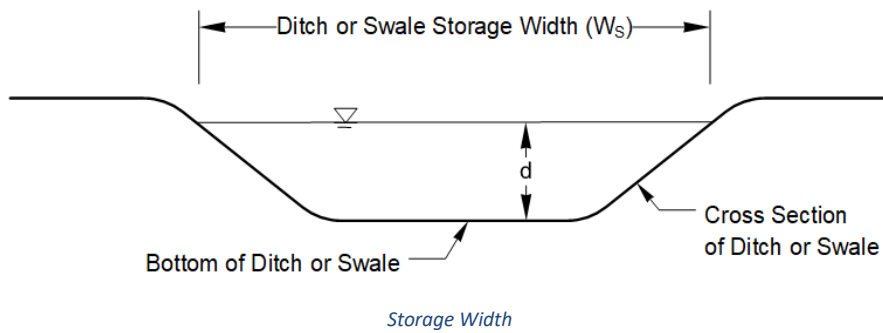
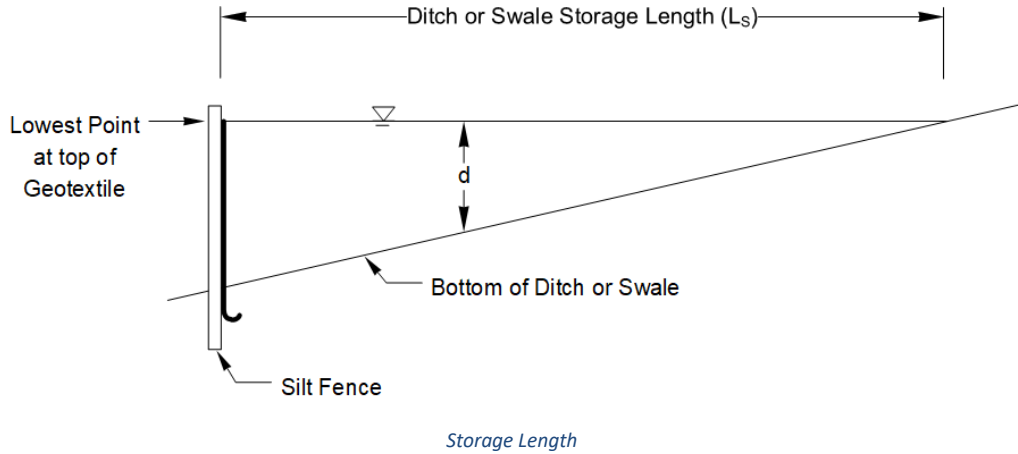
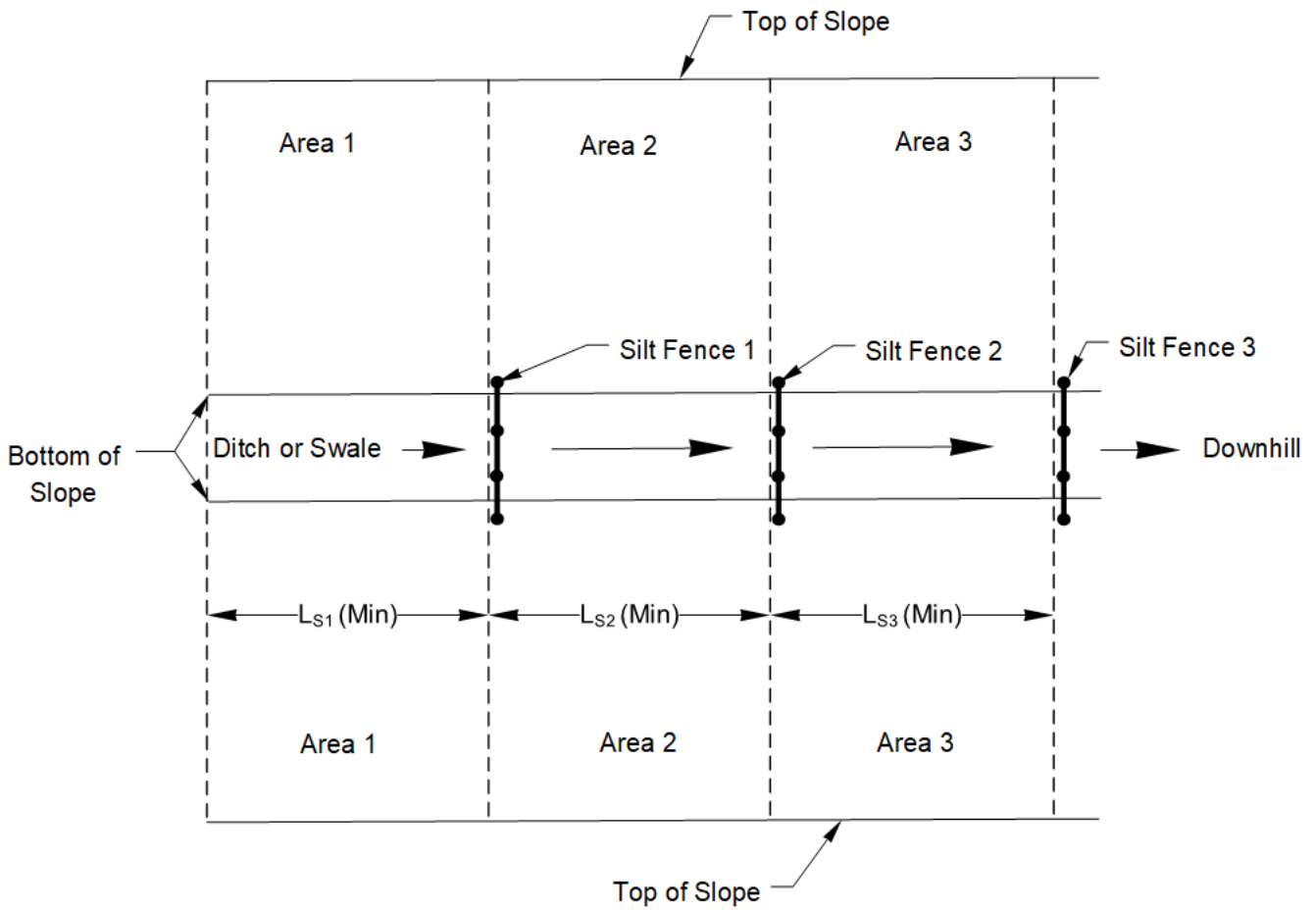



Exhibit 630-10 Silt Fences for Large Contributing Area



Method to keep contributing area to ditch or swale within allowable limits if contributing area too large based on Exhibit 630-3.

*Method to keep contributing area to ditch or swale within allowable limits if contributing area is too large based on Exhibit 630-3.*

Exhibit 630-11 Silt Fence End Treatment

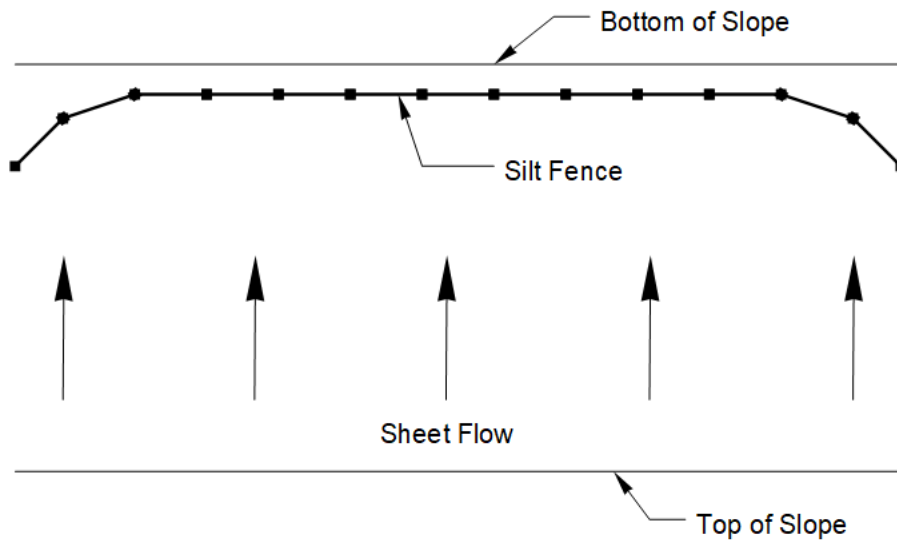

Silt Fence Plan

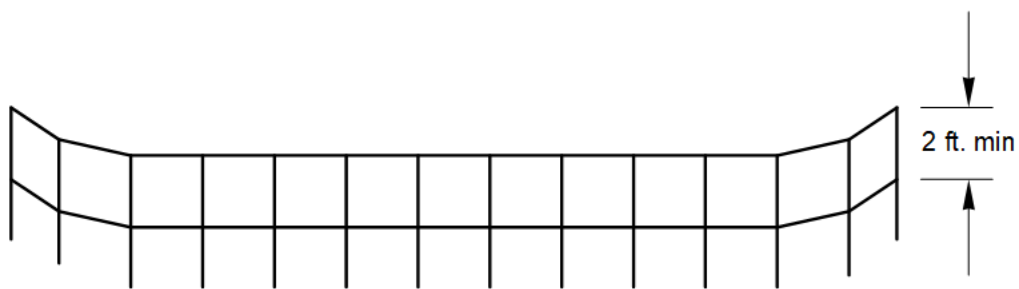

Silt Fence Profile

*Silt fence plan and profile illustrating how silt fence will capture runoff water and not allow water to run around ends of fence.*

Exhibit 630-12 Gravel Check Dams for Silt Fences

